

12" professional display chassis drawing

6mm aluminum front bezel

Model : AP-12 / HAP-12



unit : mm

Front View

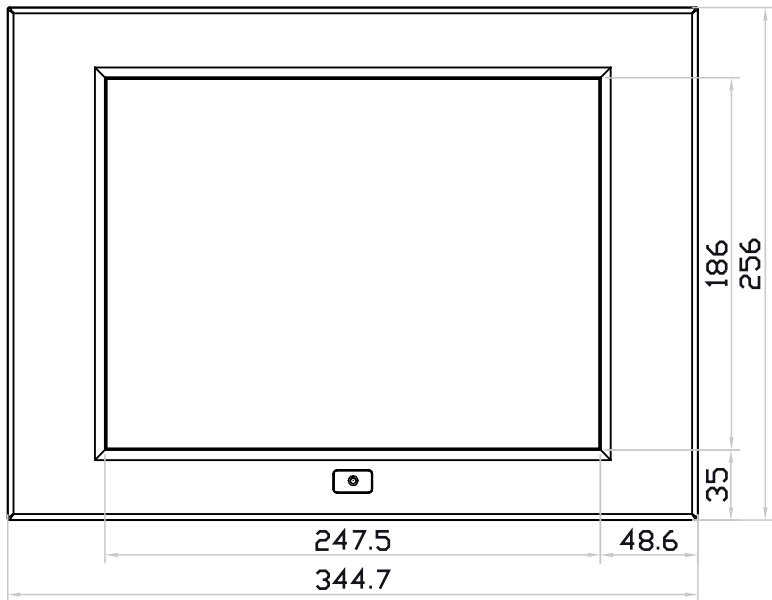

Left-side View

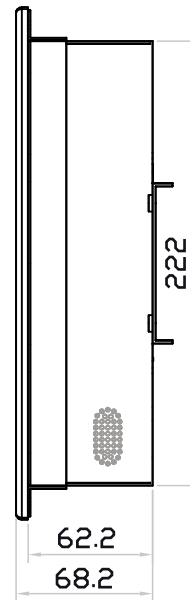

Rear View

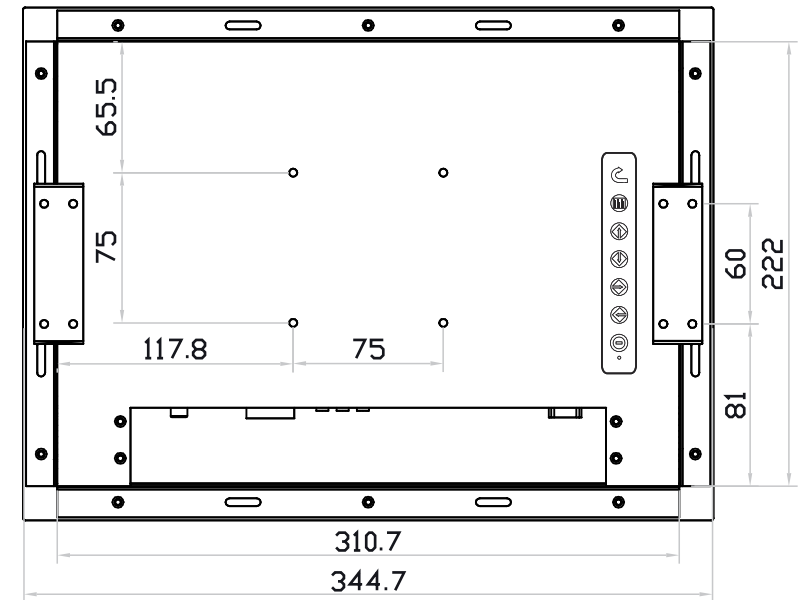

Bottom View

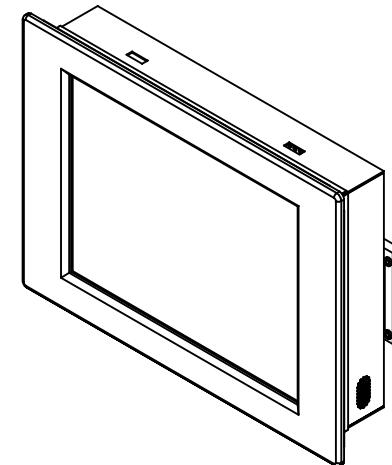
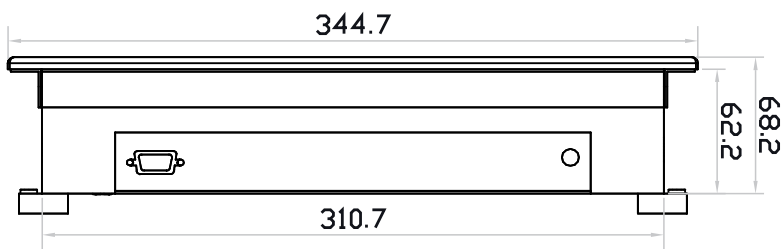

12" professional display chassis drawing

6mm aluminum front bezel with NEMA 4 / IP65 front protection

Model : NAP-12 / NHAP-12



unit : mm

Front View

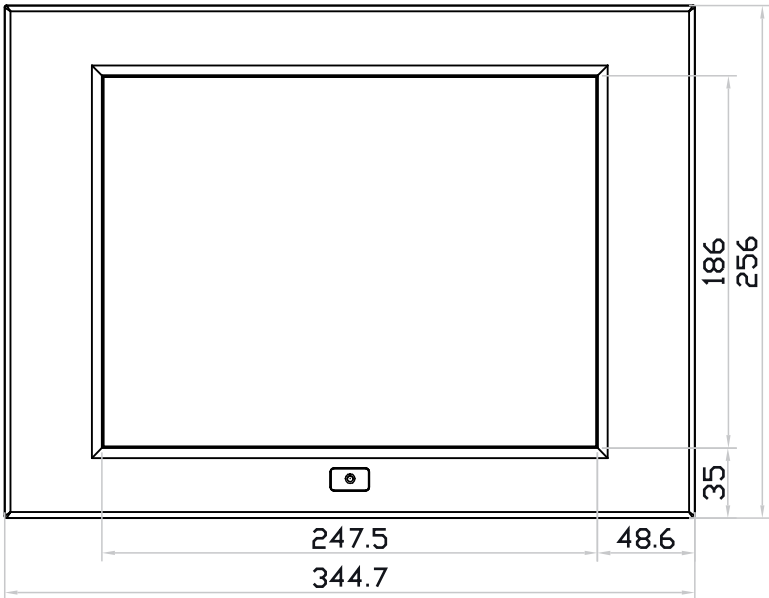

Left-side View

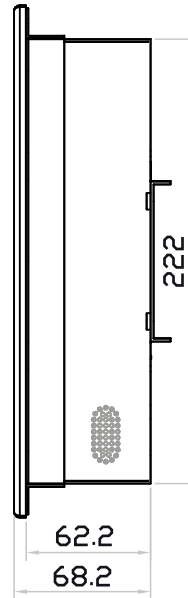

Rear View

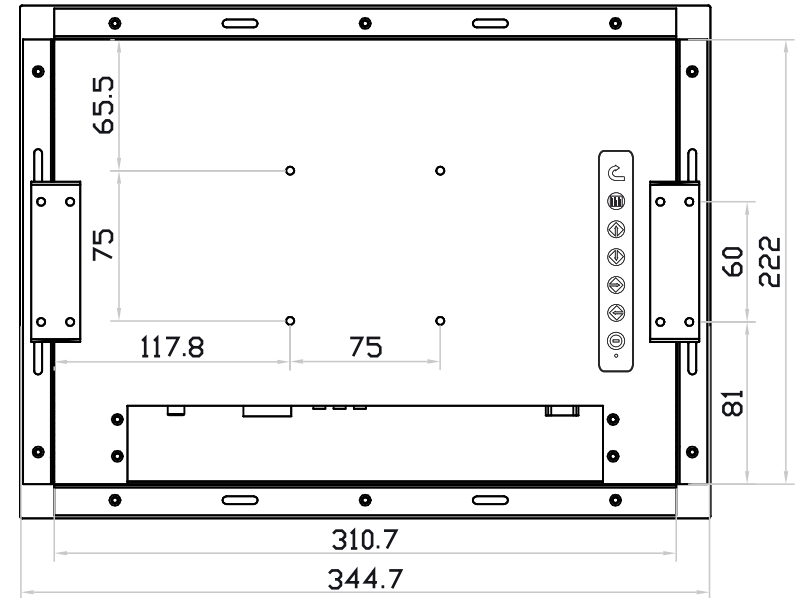

Bottom View

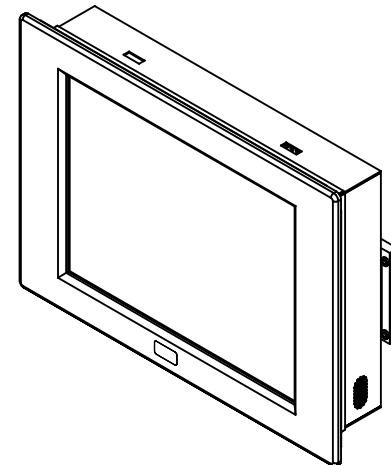
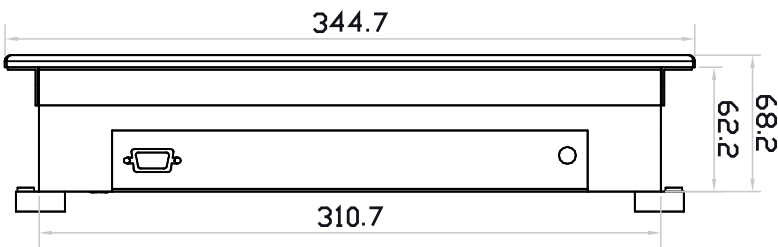

12" professional display chassis drawing

Universal open frame

Model : OP-12 / HOP-12

UltraView

unit : mm

Front View

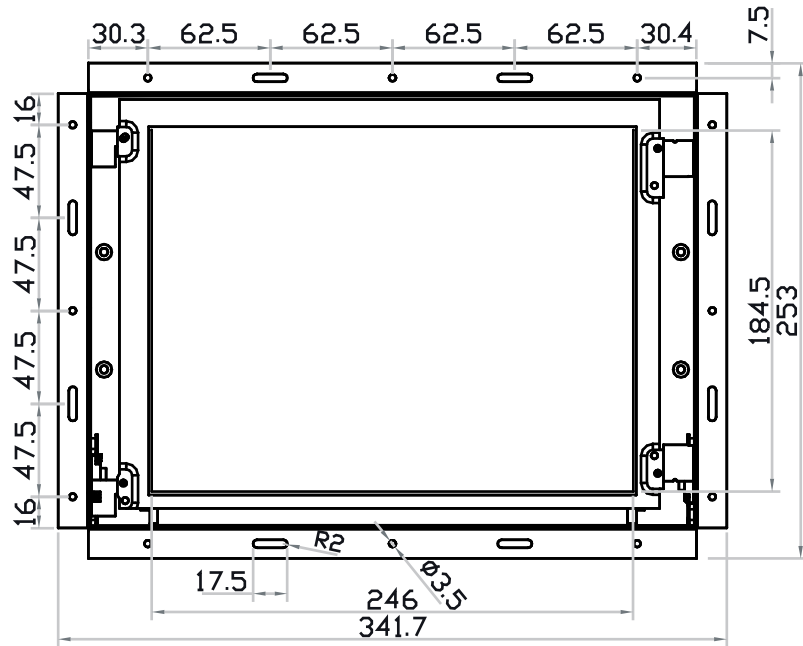

Left-side View

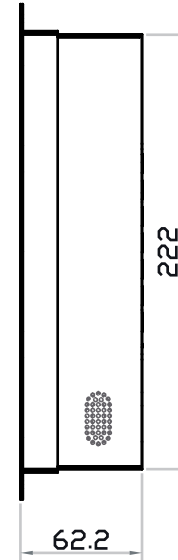

Rear View

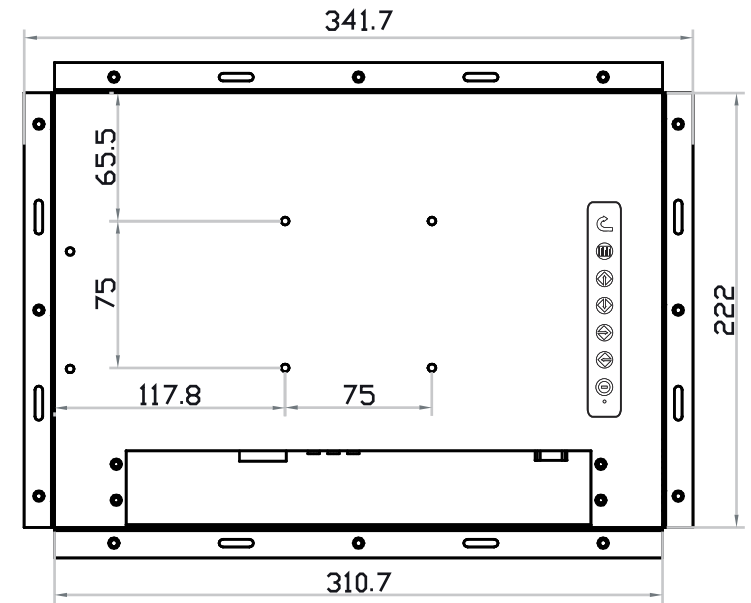

Bottom View

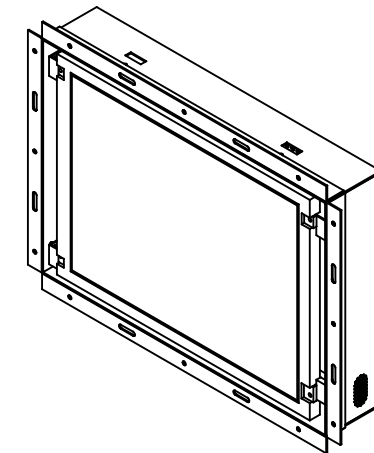
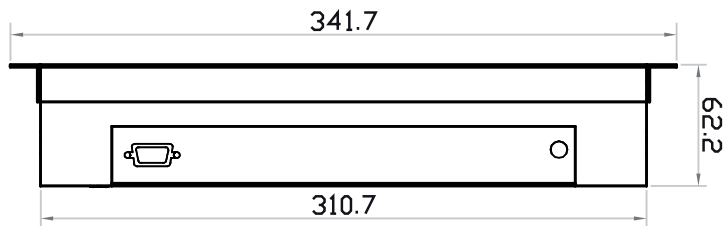

12" professional display chassis drawing

Aluminum front cover

Model : DP-12 / HDP-12



unit : mm

Front View

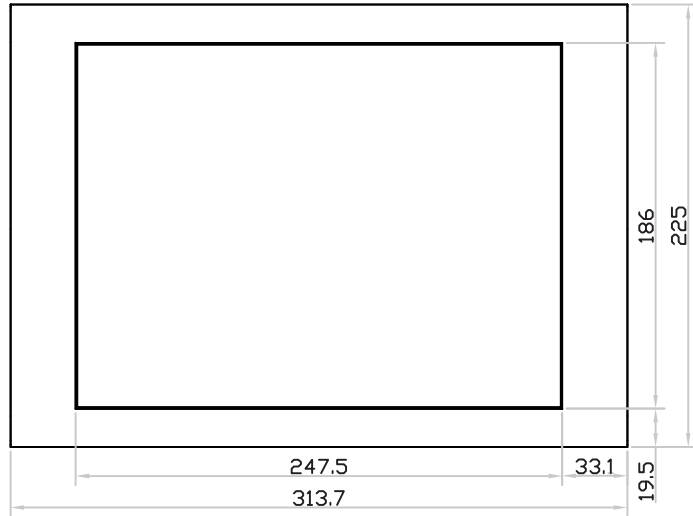

Left-side View



Rear View

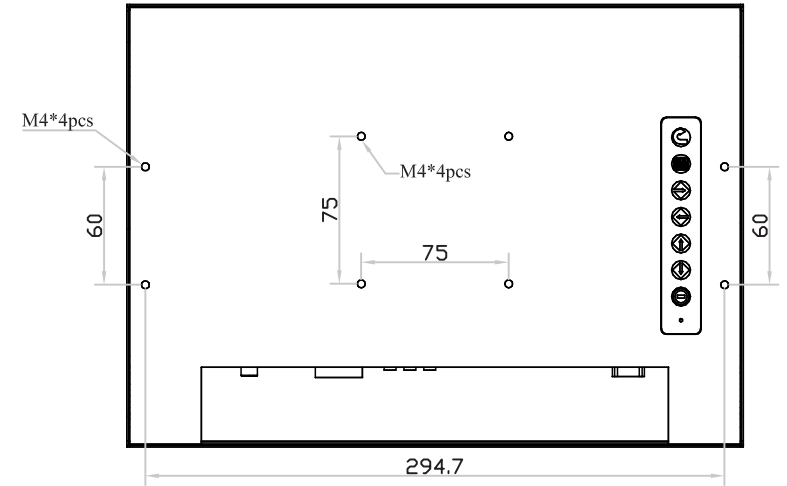

Bottom View

