

User Manual

Matrix DB-15 **IP** KVM

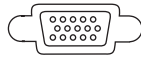

M-IP813 / 824
M-IP1613 / 1624



Matrix DB-15 KVM

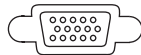

M-802 / 803 / 804
M-1602 / 1603 / 1604



751

Designed and manufactured by Austin Hughes

Legal Information

First English printing, October 2018

Information in this document has been carefully checked for accuracy; however, no guarantee is given to the correctness of the contents. The information in this document is subject to change without notice. We are not liable for any injury or loss that results from the use of this equipment.

Safety Instructions

Please read all of these instructions carefully before you use the device. Save this manual for future reference.

- Unplug equipment before cleaning. Don't use liquid or spray detergent; use a moist cloth.
- Keep equipment away from excessive humidity and heat. Preferably, keep it in an air-conditioned environment with temperatures not exceeding 40° Celsius (104° Fahrenheit).
- When installing, place the equipment on a sturdy, level surface to prevent it from accidentally falling and causing damage to other equipment or injury to persons nearby.
- When the equipment is in an open position, do not cover, block or in any way obstruct the gap between it and the power supply. Proper air convection is necessary to keep it from overheating.
- Arrange the equipment's power cord in such a way that others won't trip or fall over it.
- If you are using a power cord that didn't ship with the equipment, ensure that it is rated for the voltage and current labeled on the equipment's electrical ratings label. The voltage rating on the cord should be higher than the one listed on the equipment's ratings label.
- Observe all precautions and warnings attached to the equipment.
- If you don't intend on using the equipment for a long time, disconnect it from the power outlet to prevent being damaged by transient over-voltage.
- Keep all liquids away from the equipment to minimize the risk of accidental spillage. Liquid spilled on to the power supply or on other hardware may cause damage, fire or electrical shock.
- Only qualified service personnel should open the chassis. Opening it yourself could damage the equipment and invalidate its warranty.
- If any part of the equipment becomes damaged or stops functioning, have it checked by qualified service personnel.

What the warranty does not cover

- Any product, on which the serial number has been defaced, modified or removed.
- Damage, deterioration or malfunction resulting from:
 - Accident, misuse, neglect, fire, water, lightning, or other acts of nature, unauthorized product modification, or failure to follow instructions supplied with the product.
 - Repair or attempted repair by anyone not authorized by us.
 - Any damage of the product due to shipment.
 - Removal or installation of the product.
 - Causes external to the product, such as electric power fluctuation or failure.
 - Use of supplies or parts not meeting our specifications.
 - Normal wear and tear.
 - Any other causes which does not relate to a product defect.
- Removal, installation, and set-up service charges.

Regulatory Notices Federal Communications Commission (FCC)

This equipment has been tested and found to comply with the limits for a Class B digital device, pursuant to Part 15 of the FCC rules. These limits are designed to provide reasonable protection against harmful interference in a residential installation.

Any changes or modifications made to this equipment may void the user's authority to operate this equipment. This equipment generates, uses, and can radiate radio frequency energy and, if not installed and used in accordance with the instructions, may cause harmful interference to radio communications.

However, there is no guarantee that interference will not occur in a particular installation. If this equipment does cause harmful interference to radio or television reception, which can be determined by turning the equipment off and on, the user is encouraged to try to correct the interference by one or more of the following measures:

- Re-position or relocate the receiving antenna.
- Increase the separation between the equipment and receiver.
- Connect the equipment into an outlet on a circuit different from that to which the receiver is connected.

Contents

< Part 1 > Matrix DB-15 KVM

M-IP813	M-IP824
M-IP1613	M-IP1624

1.1	Package contents	P.1
1.2	KVM port connection	P.2
1.3	IP, Remote & Local console connection	P.3 - 4
1.4	IP console setting	P.5
1.5	Important Preconfiguration for IP console	P.6 - 8
1.6	KVM Cascade	P.9
1.7	Specifications	P.10

< Part 2 > Matrix DB-15 KVM

M-802	M-803	M-804
M-1602	M-1603	M-1604

2.1	Package contents	P.11
2.2	KVM port connection	P.12 - 13
2.3	Remote & Local console connection	P.14 - 15
2.4	KVM Cascade	P.16
2.5	Specifications	P.17

< Part 3 > Usage

3.1	KVM Button	P.18
3.2	Password	P.19
3.3	KVM OSD	P.20
3.4	KVM Hotkey & Remote Console Hotkey	P.21

Before Installation

- It is very important to mount the equipment in a suitable cabinet or on a stable surface.
- Make sure the place has a good ventilation, is out of direct sunlight, away from sources of excessive dust, dirt, heat, water, moisture and vibration.

Unpacking

The equipment comes with the standard parts shown in package content. Check and make sure they are included and in good condition. If anything is missing, or damaged, contact the supplier immediately.

Installation for standalone KVM

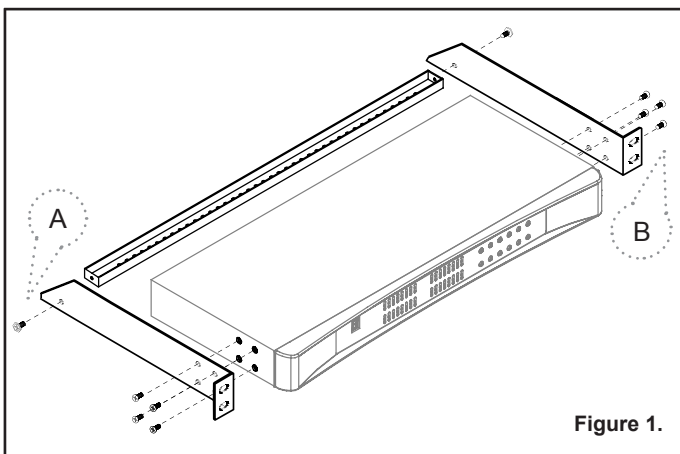

Figure 1.

Screw A: 2 pcs



M3.2 x 4.5 mm

Screw B: 8 pcs



M4 x 10 mm

- Install each bracket using screws provided shown in **Figure 1**.

- Fix the KVM into the rack

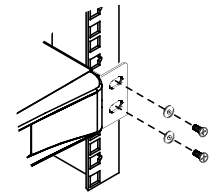

M-IP813 / M-IP1613
M-IP824 / M-IP1624

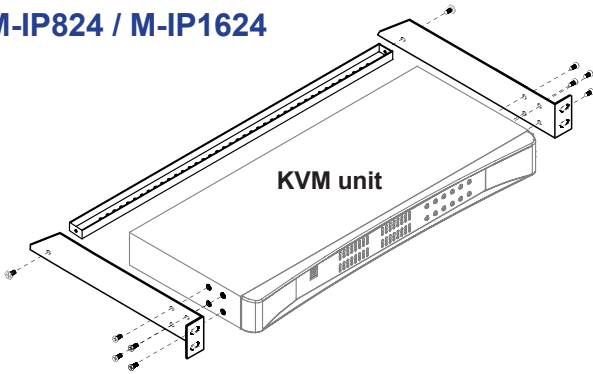

- M-IP813 or M-IP1613 or M-IP824 or M-IP1624 KVM unit x 1
- Mounting set w/ bracket & screws x 1
- Power adapter w/ power cord (for KVM) x 1
- Receiver box for remote console x 1
- Power adapter w/ power cord (for receiver) x 1
- CE-6 6ft Combo KVM cable for receiver box x 1

M-IP813

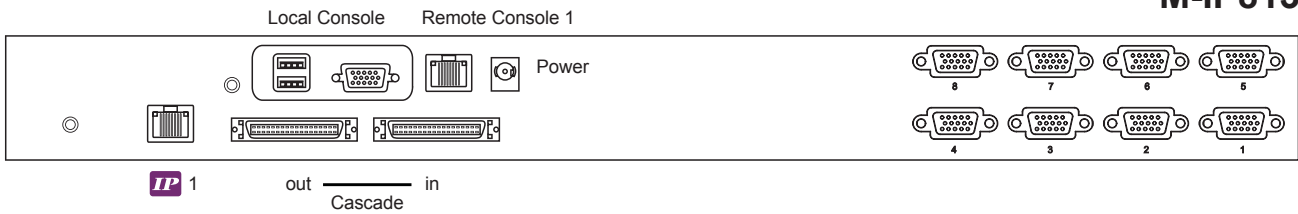

M-IP1613

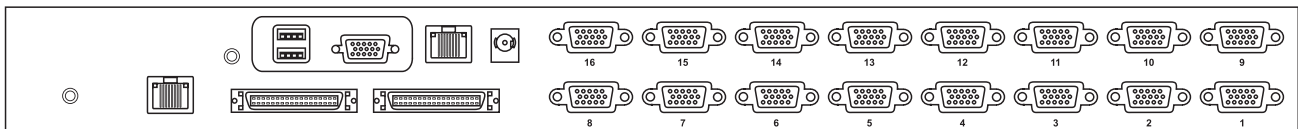

M-IP824

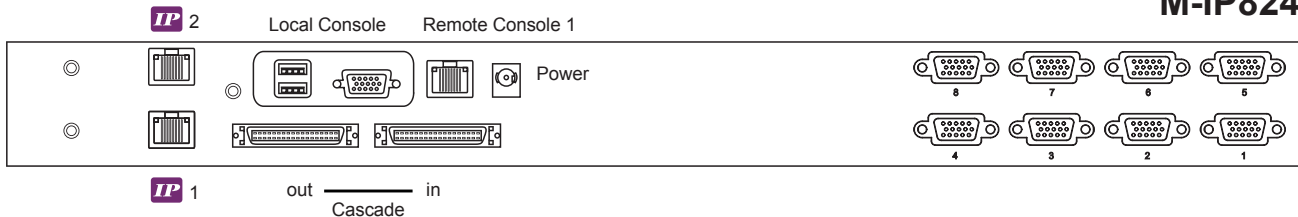

M-IP1624

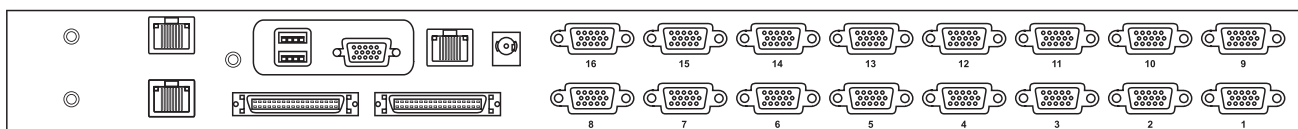

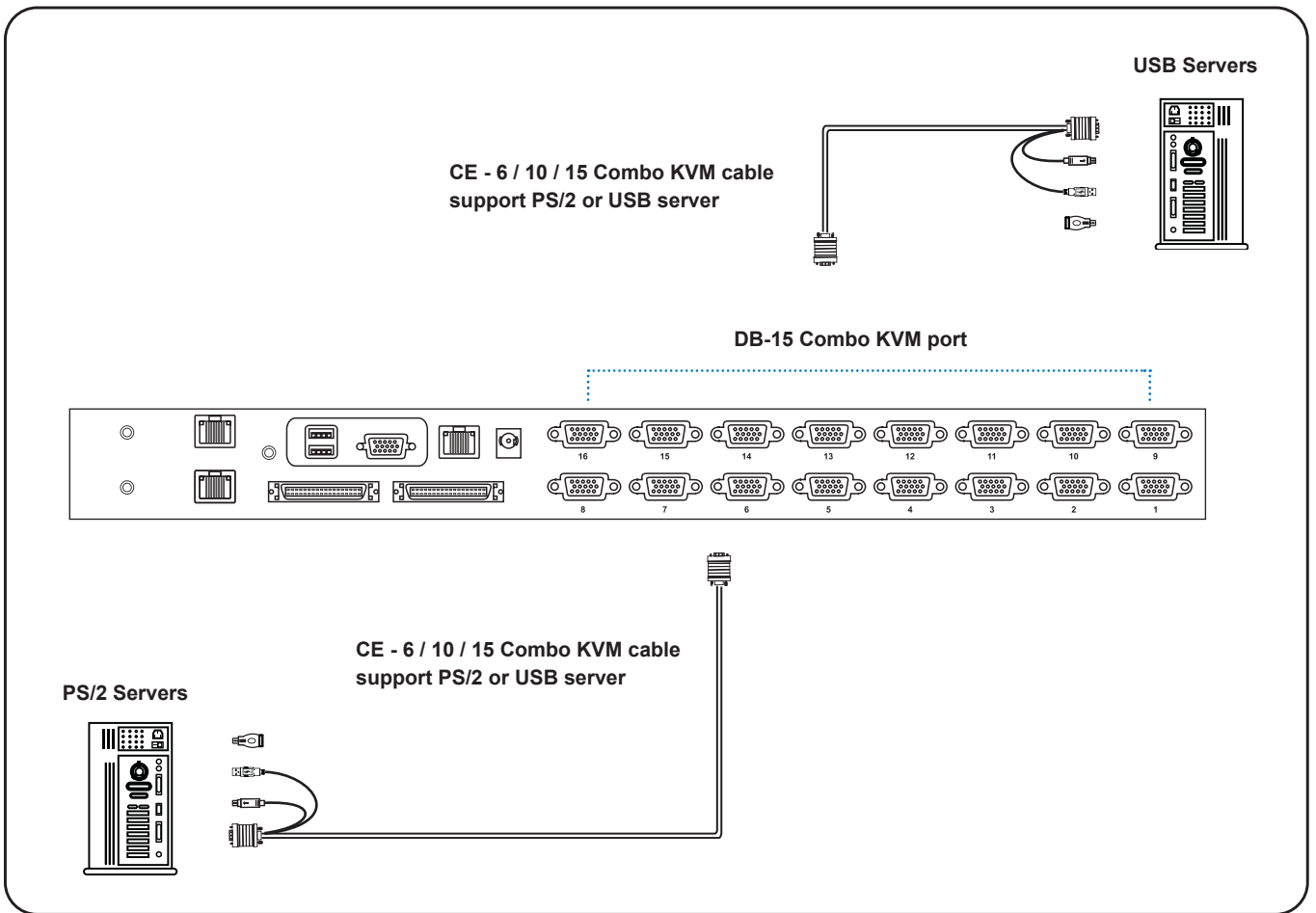

CE-6 / CE-10 / CE-15

- 6 / 10 / 15 ft Combo KVM cable
- Support PS/2 or USB server



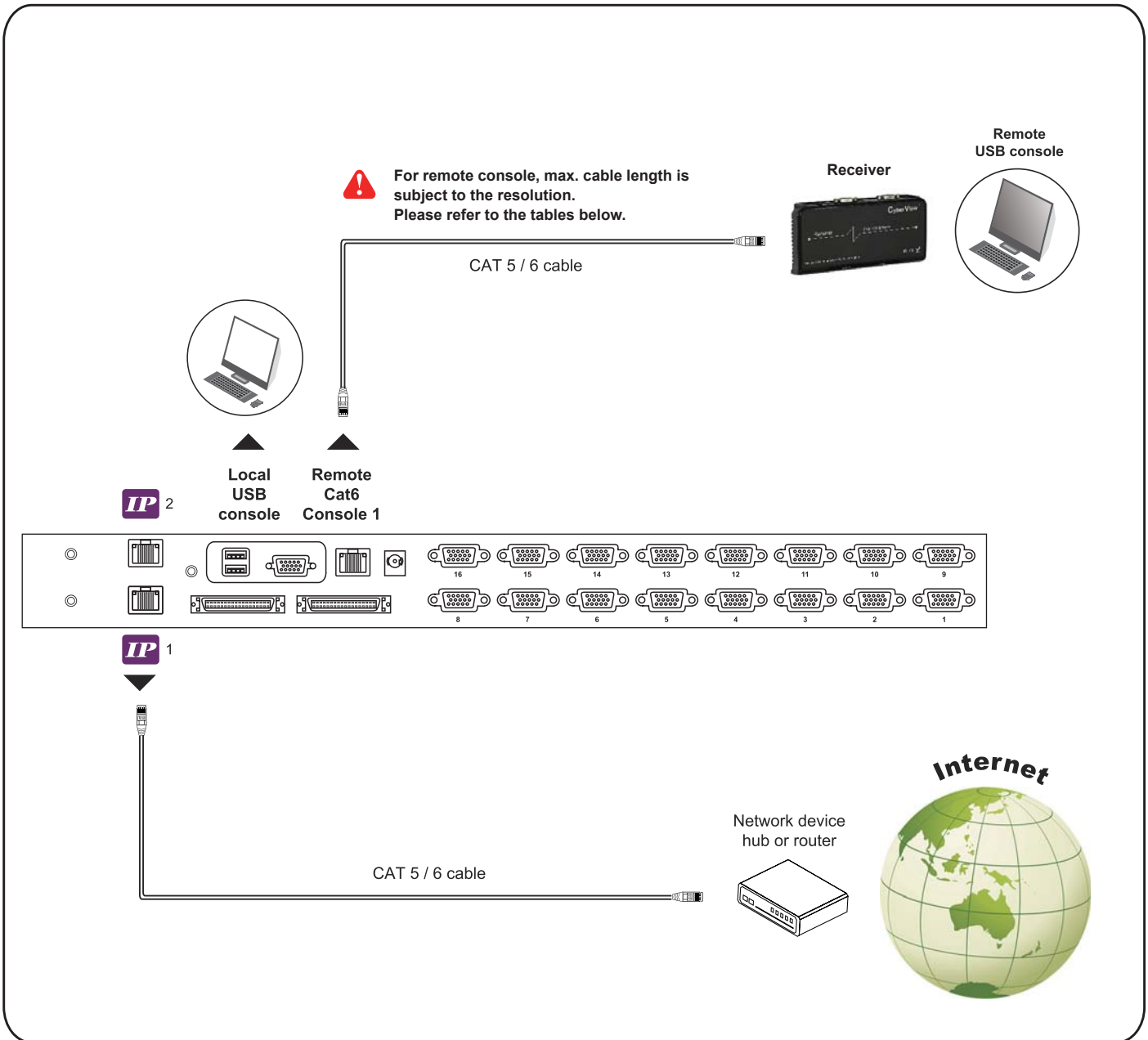

Remote Console

Resolution Support	Frequency (Hz)	Max. Cat6 Cable Length (M)
1920 x 1200	60	50
1920 x 1080	60	50
1600 x 1200	60	100
1440 x 900	60	100
1280 x 1024	60	150

IP Console

Resolution Support	Frequency (Hz)
1600 x 1200	60
1280 x 1024	60

Receiver

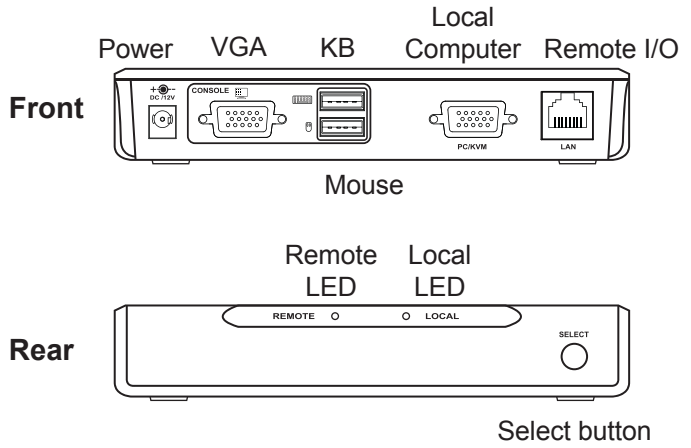

The receiver provides a hotkey function for remote console. Please refer to P.21

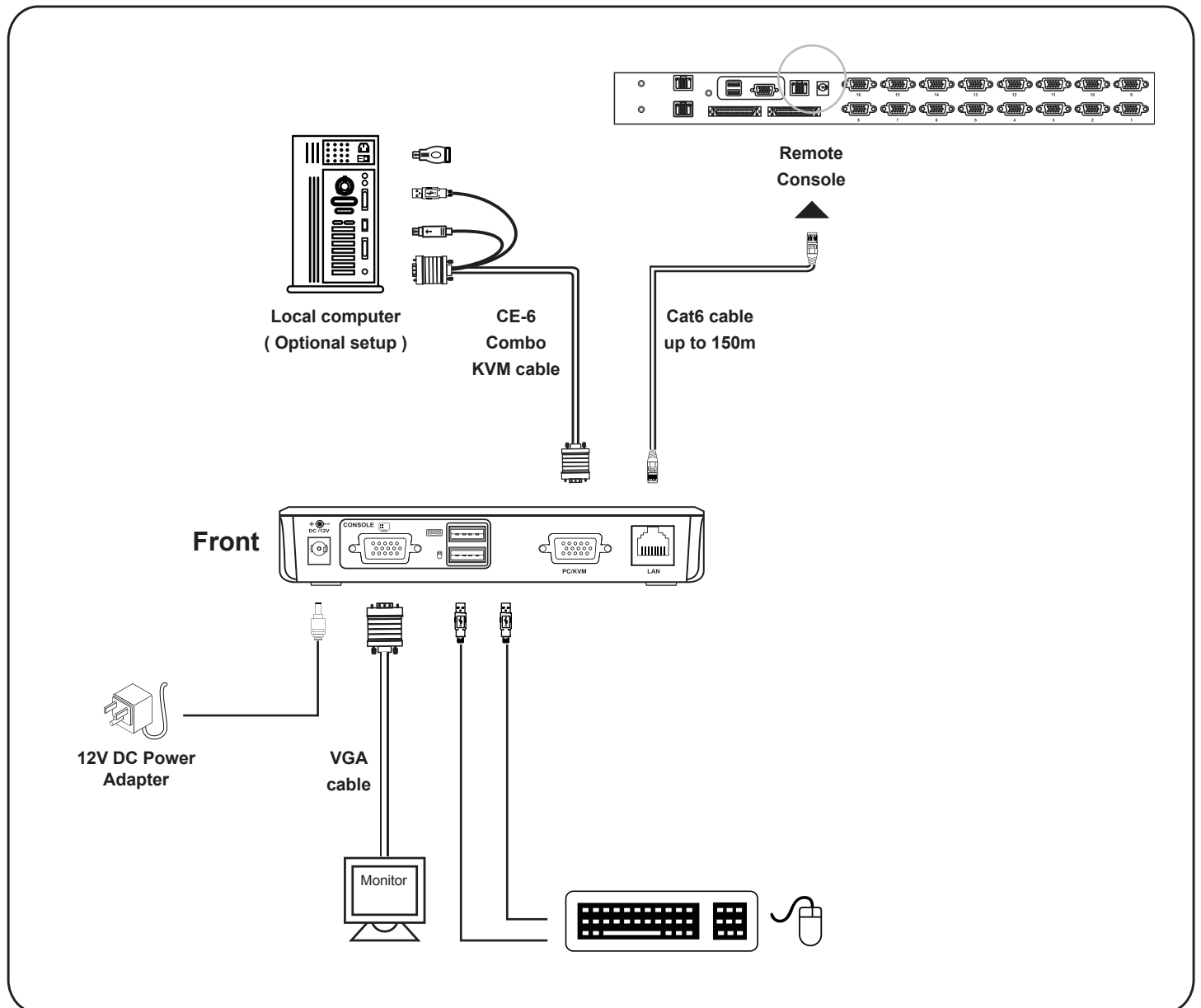

After the cable connection, please take the following steps to configure the IP KVM :

1. Download **IPKVMsetup.exe** from the link:

www.austin-hughes.com/support/utilities/cyberview/IPKVMsetup.exe

2. Double click **IPKVMsetup.exe** to configure the IP KVM by device setup as below.

3. Click **Refresh Device** to search the connected IP KVM

4. Select the M.A.C. address, which you want to setup, then click **Query Device**

5. Enter Super user login. **The default is super**

6. Enter Super user password. **The default is pass**

7. Enter the new super user password

8. Re-enter the new password

9. Change the desired IP address / Subnet mask / Gateway, then click **Setup Device** to confirm the setting to IP KVM

10. The default address is as below:--

- The single IP KVM model, such as M-IP1613 - http://192.168.1.22
- The dual IP KVM model, such as M-IP1624 - http://192.168.1.22 (for 1st IP)
http://192.168.1.23 (for 2nd IP)

11. Open Internet Explorer (I.E.), version 6.0 or above

12. Enter the IP KVM address into the address bar

- For Single IP - http://192.168.1.22

- For Dual IP - http://192.168.1.22 (for 1st IP)
http://192.168.1.23 (for 2nd IP)

13. Enter username (default is super)

Password (default is pass)

14. After successful login to IP KVM, the user will enter the main page of IP KVM



The setting is enough for intranet.

If the users access KVM GUI via internet, please ask MIS for assistance and download IP KVM user manual from the link :

www.austin-hughes.com/support/usermanual/cyberview/UM-CV-IP.pdf



You must complete the following tasks after the IP console setting is performed.

(1) TARGET SERVER SETUP **Servers connected to KVM

Resolution

The IP KVM remote console recognizes several varieties of video display formats with resolutions up to 1600 x 1200 @60Hz. (Refer to the User Manual for a list of supported video formats). Minimize bandwidth by setting the target server's video resolution to the minimum setting required for your remote monitoring application.

The following video modes are recommended:

- (i) 1024 x 768 @ 60Hz
- (ii) 1280 x 1024 @ 60Hz

On a Windows target server system, select Control Panel > Display > Settings.
Modify the screen resolution value as necessary.

Mouse

Use generic mouse drivers for optimum mouse control during remote sessions. Set the mouse pointer speed to a middle setting with no acceleration or snap-to effects.

On a Windows target server system, select Control Panel > Mouse > Pointer Options
Set the pointer speed to medium and disable Enhanced pointer precision

For Linux GUIs, set the mouse acceleration to exactly 1 and the threshold to exactly 1.



If your keyboard keeps repeating keys when it is plugged into the KVM. Please follow either one below :

(a.)

Enable key release timeout if you experience duplicated keystrokes during poor network performance.

- login to IP KVM remote console
- go to Interfaces KVM settings > Keyboard / Mouse
- click the Key Release Timeout
- adjust Timeout after if necessary

(b.)

Reduce video bandwidth usage if you experience duplicated keystrokes during poor network

- login to IP KVM remote console
- go to Interfaces KVM Settings > User Console > Transmission Encoding,
- select Manually
- adjust Compression to [0-none] and Color depth to [8-bit – 256 col]

(2) REMOTE CLIENT COMPUTER SETUP

The remote client computer must have a web browser (such as Microsoft Internet Explorer, Mozilla Firefox, and Netscape Navigator) and a Java Virtual Machine (version 1.4 or higher) installed. Enable Java on the web browser.



JAVA Update for IP KVM

Due to the latest update from Java security, customer may face the "JAVA Block" message while accessing the remote console over IP as below :

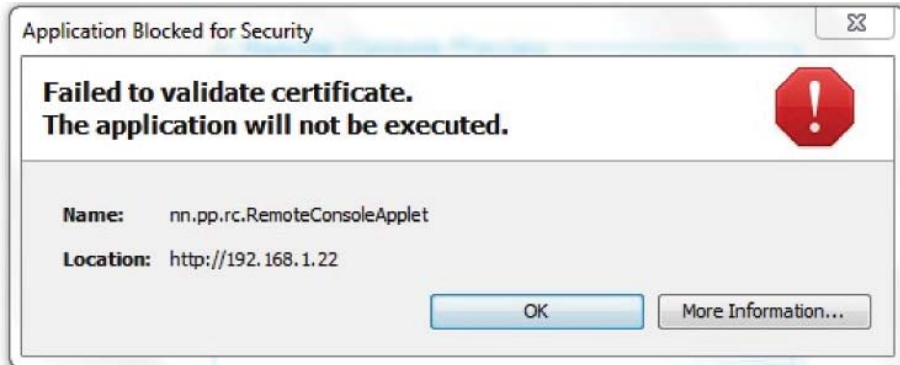

If it said so, please download the latest IP KVM firmware (version aust-i11-150608) from the link below : <http://www.austin-hughes.com/resources/software/kvm-switch>

Then follow the attached steps to update the firmware.

Firmware Update Steps

- 1) Download the latest IP KVM firmware (version aust-i11-150608) from the link <http://www.austin-hughes.com/resources/software/kvm-switch>
- 2) Login the IP KVM
- 3) Click < Update Firmware >
- 4) Click < Browse > to select the firmware file
- 5) Click < Upload >

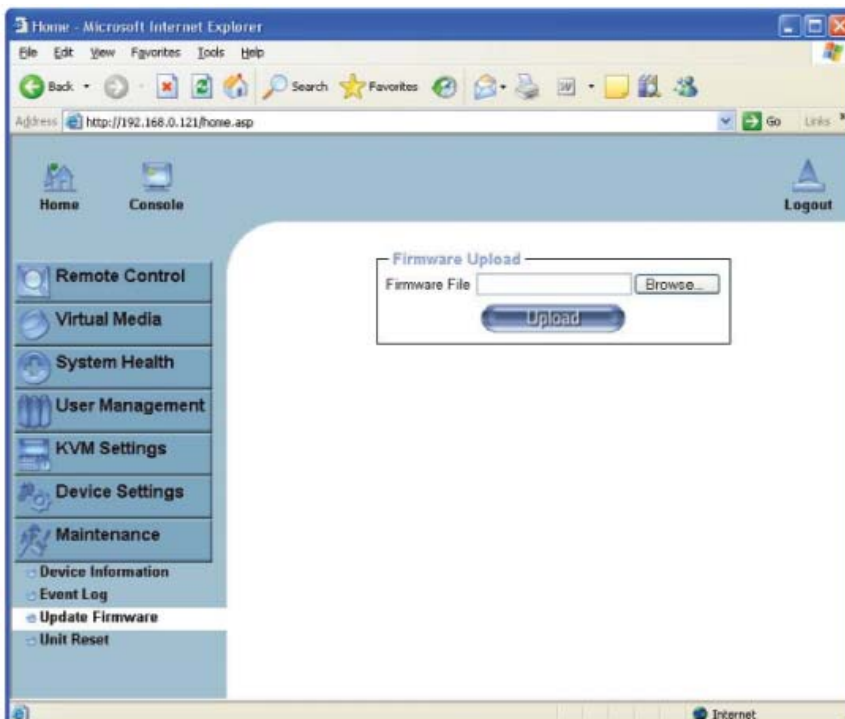

6) Click < Update >

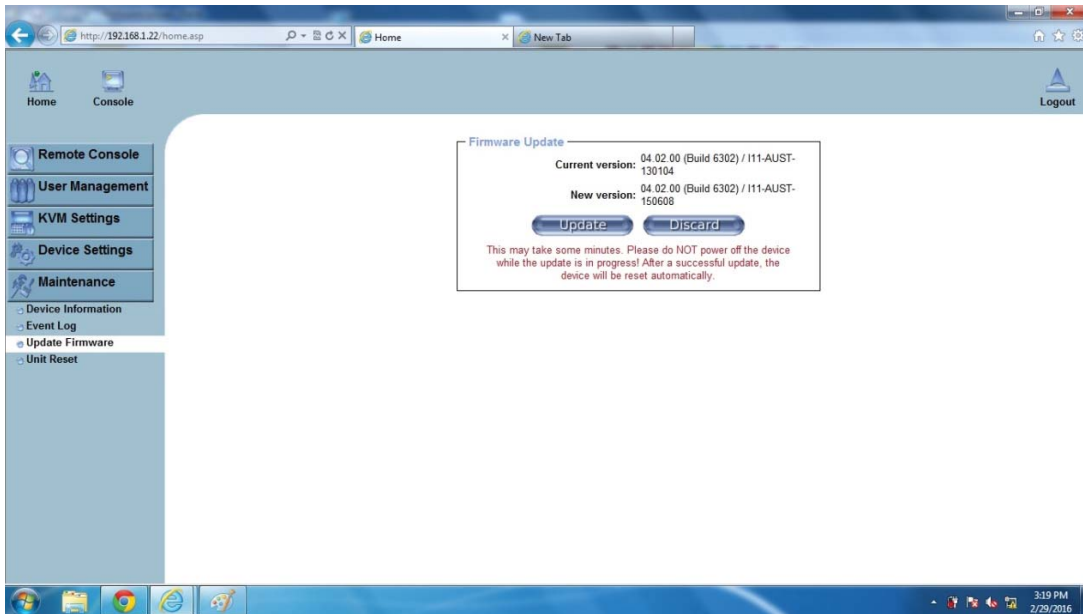

After the firmware has been updated, IP KVM will reset automatically. After one minute, you will be redirected to the Login page and requested to login again.

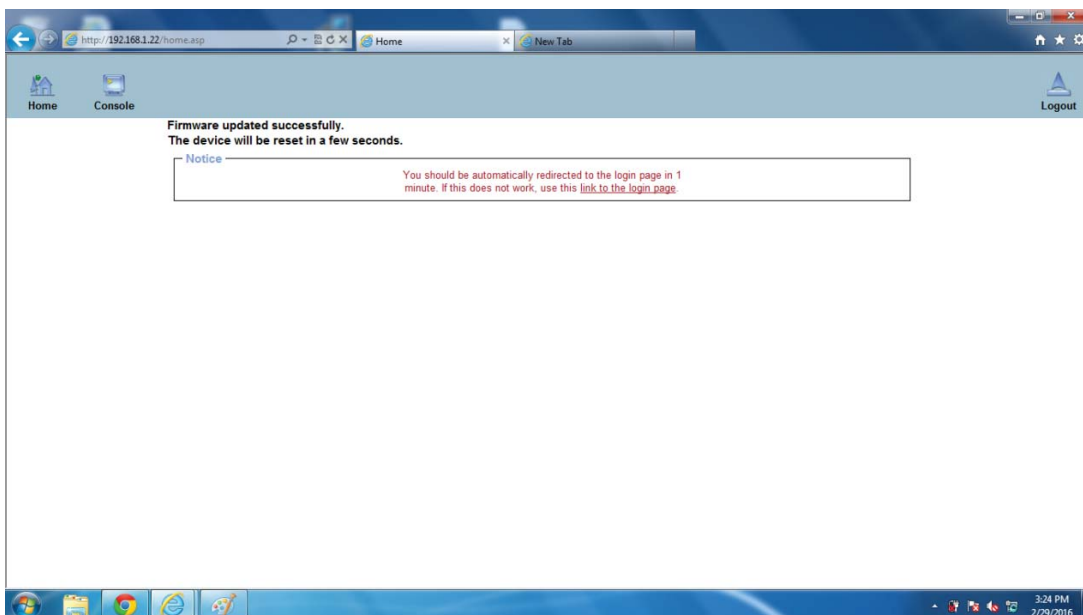

- Completed

< 1.6 > KVM Cascade

- Cascade up to 8 levels, 240 servers
- Cascading multiple KVM with CMC-8 cascade cable.

! Cascaded KVMs from level 2 to 8 must be the models of M-802 / M-1602 or MU-1602 / MU-3202.

! When multiple matrix KVMs cascade together, the master KVM at level 1 will take all control of other slave KVM switches (e.g. level 2 to 8).

! The slave matrix KVM will be as a port expansion module of the master matrix KVM, the original remote console on slave KVM will be sacrificed and disabled.

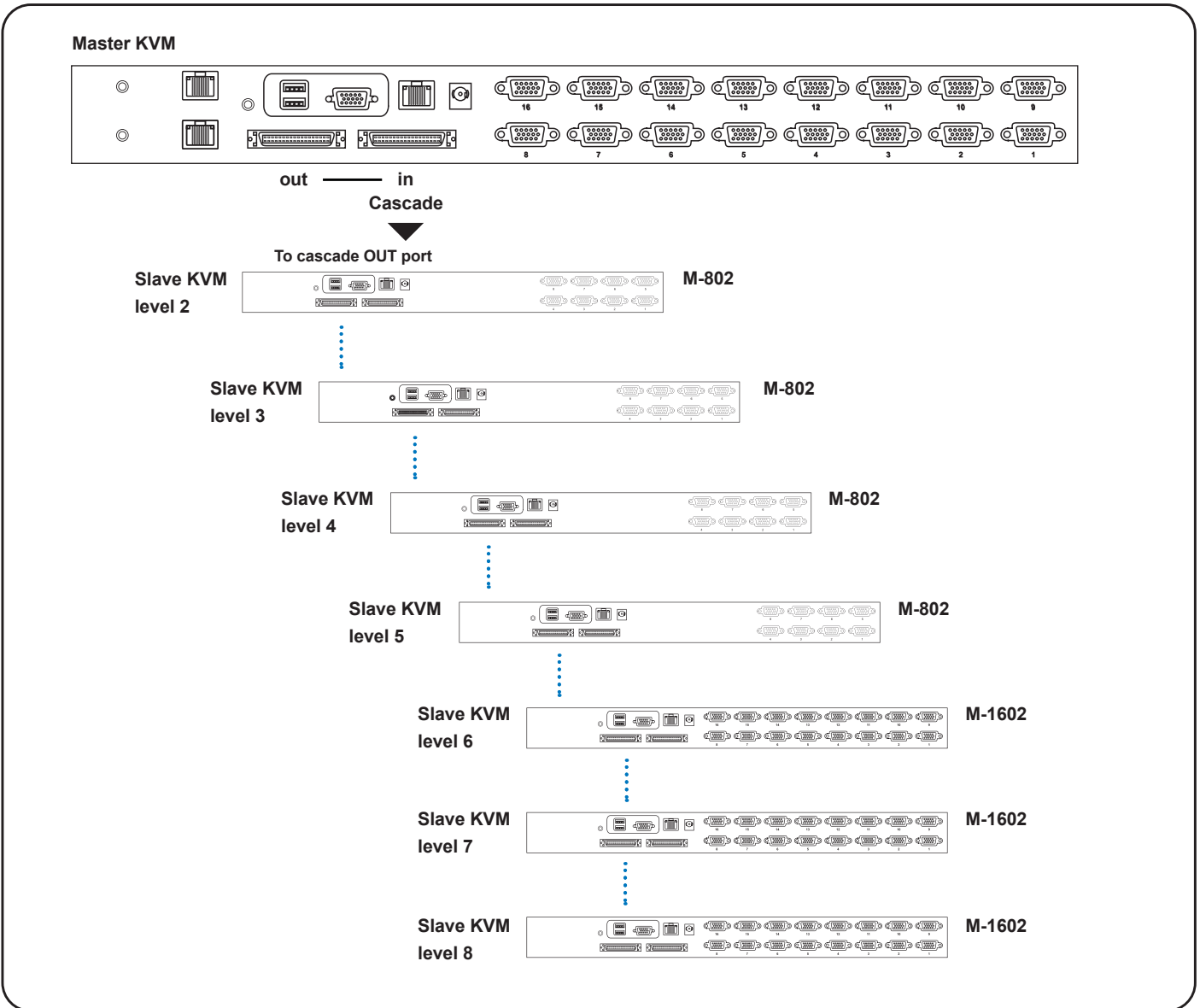

CMC-8

- 8ft Matrix KVM cascade cable

	M-IP813 M-IP1613	M-IP824 M-IP1624
<p>■ KVM Port</p> <p>Number of ports : 8 or 16</p> <p>Connector : DB-15 combo connector</p> <p>Connectivity : Combo 4-in-1 KVM cable up to 6, 10 & 15 feet</p>		
<p>■ Local Console</p> <p>Monitor port : 1 x DB-15 VGA</p> <p>Keyboard & mouse port : 2 x USB type connector for keyboard & mouse</p> <p>Resolution support : 4:3 - max. 1600 x 1200, 16:10 - max. 1920 x 1200</p>		
<p>■ Cat6 Remote Console</p> <p>Number of remote port : 1</p> <p>Monitor port : DB15-pin VGA</p> <p>Keyboard & mouse port : 2 x USB type connector for keyboard & mouse</p> <p>Remote I/O : RJ45 via Cat5 / Cat5e / Cat6 cable up to 500 feet</p> <p>Resolution support : 4:3 - max. 1600 x 1200, 16:10 - max. 1920 x 1200</p>		
<p>■ IP Remote Console</p> <p>Number of IP console : 1 for M-IP813 / M-IP1613 2 for M-IP824 / M-IP1624</p> <p>User management : 15-user login, 1 x active user</p> <p>Browser : Internet Explorer, Firefox, Safari</p> <p>Security : SSL v3, RSA, AES, HTTP / HTTPS, CSR</p> <p>IP Access : RJ45 Ethernet per IP console</p> <p>Resolution support : 4:3 - max. 1600 x 1200</p>		
<p>■ Expansion :</p> <p>Up to 240 servers by 8-level cascade</p>		
<p>■ Compatibility</p> <p>Hardware : HP / IBM / Dell PC, Server and Blade Server SUN / Mac</p> <p>OS Support : Windows / Linux / Unix / Mac OS</p>		
<p>■ Power</p> <p>Input : AC power adapter</p> <p>Consumption : Max. 29W</p>		
<p>■ Regulatory</p> <p>Safety : cUL, FCC & CE certified</p> <p>Environment : RoHS2 & REACH compliant</p>		
<p>■ Environmental</p> <p>Temperature : 0 to 55°C degree</p> <p>Humidity : 20~90%, non-condensing</p> <p>Altitude : 16,000 ft</p> <p>Shock : -</p> <p>Vibration : -</p>	<p>Operating</p>	<p>Storage / Non-operating</p> <p>-20 to 60°C degree</p> <p>5~90%, non-condensing</p> <p>40,000 ft</p> <p>10G acceleration (11ms duration)</p> <p>5~500Hz 1G RMS random</p>
<p>■ Product Information</p> <p>Dimension (W x D x H) : 443 x 171 x 44 mm / 17.4 x 6.7 x 1.73 inch</p> <p>Net weight : 3 kg / 6.5 lb</p>		
<p>■ Packing Information</p> <p>Dimension (W x D x H) : 500 x 400 x 90 mm / 19.7 x 15.7 x 3.5 inch</p> <p>Gross weight : 5 kg / 11 lb</p>		

M-802 / M-1602

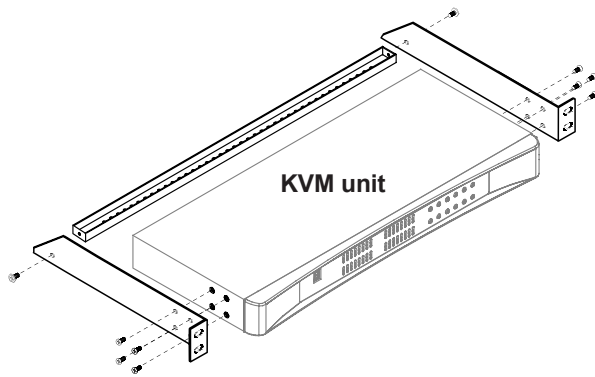

- M-802 or M-1602 KVM unit x 1
- Mounting set w/ bracket & screws x 1
- Power adapter w/ power cord (for KVM) x 1
- Receiver box for remote console x 1
- Power adapter w/ power cord (for receiver) x 1
- CE-6 6ft Combo KVM cable for receiver box x 1

M-803 / M-1603

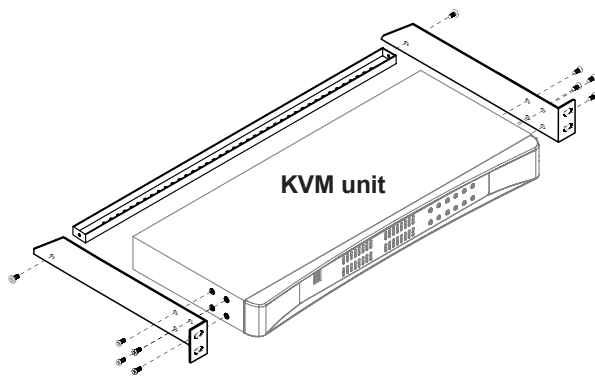

- M-803 or M-1603 KVM unit x 1
- Mounting set w/ bracket & screws x 1
- Power adapter w/ power cord (for KVM) x 1
- Receiver box for remote console x 2
- Power adapter w/ power cord (for receiver) x 2
- CE-6 6ft Combo KVM cable for receiver box x 2

M-804 / M-1604

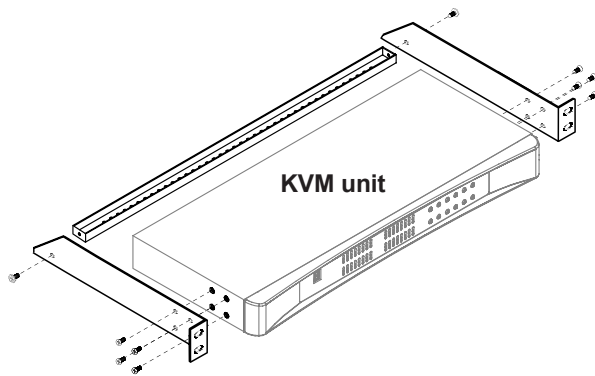

- M-804 or M-1604 KVM unit x 1
- Mounting set w/ bracket & screws x 1
- Power adapter w/ power cord (for KVM) x 1
- Receiver box for remote console x 3
- Power adapter w/ power cord (for receiver) x 3
- CE-6 6ft Combo KVM cable for receiver box x 3

M-802

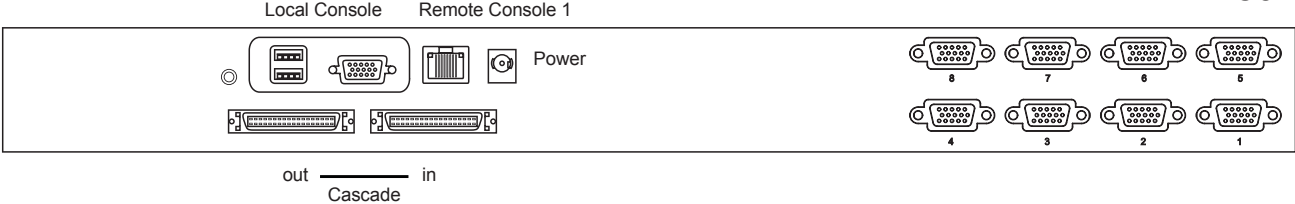

M-1602

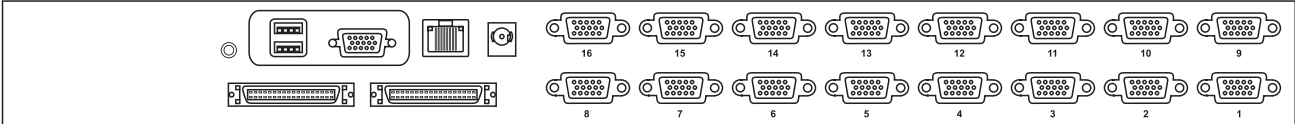

M-803

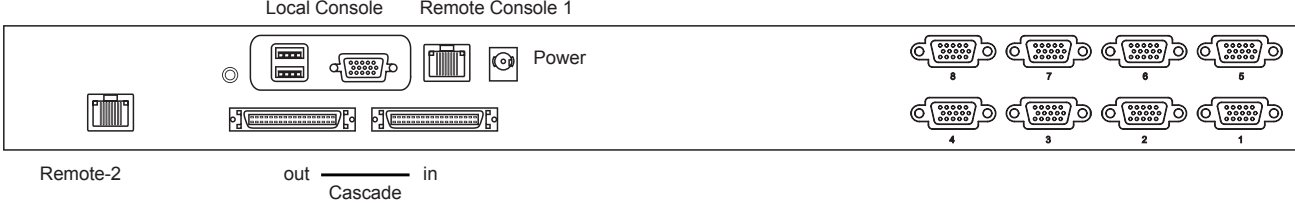

M-1603

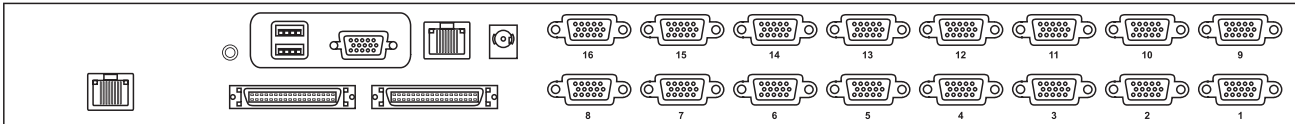

M-804

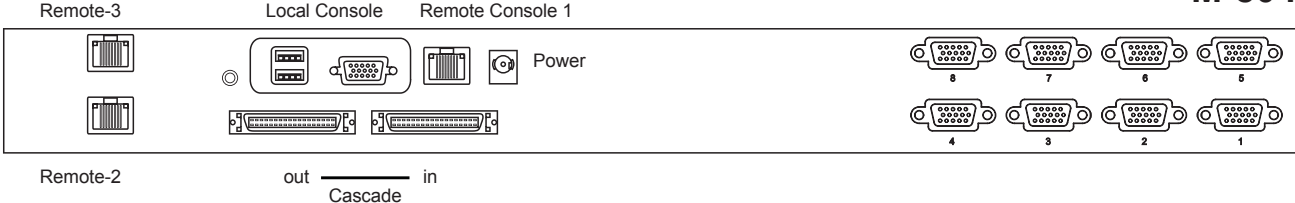

M-1604

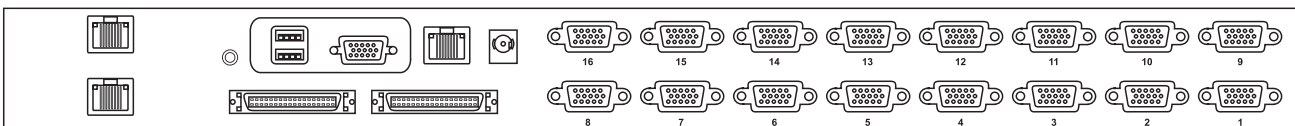

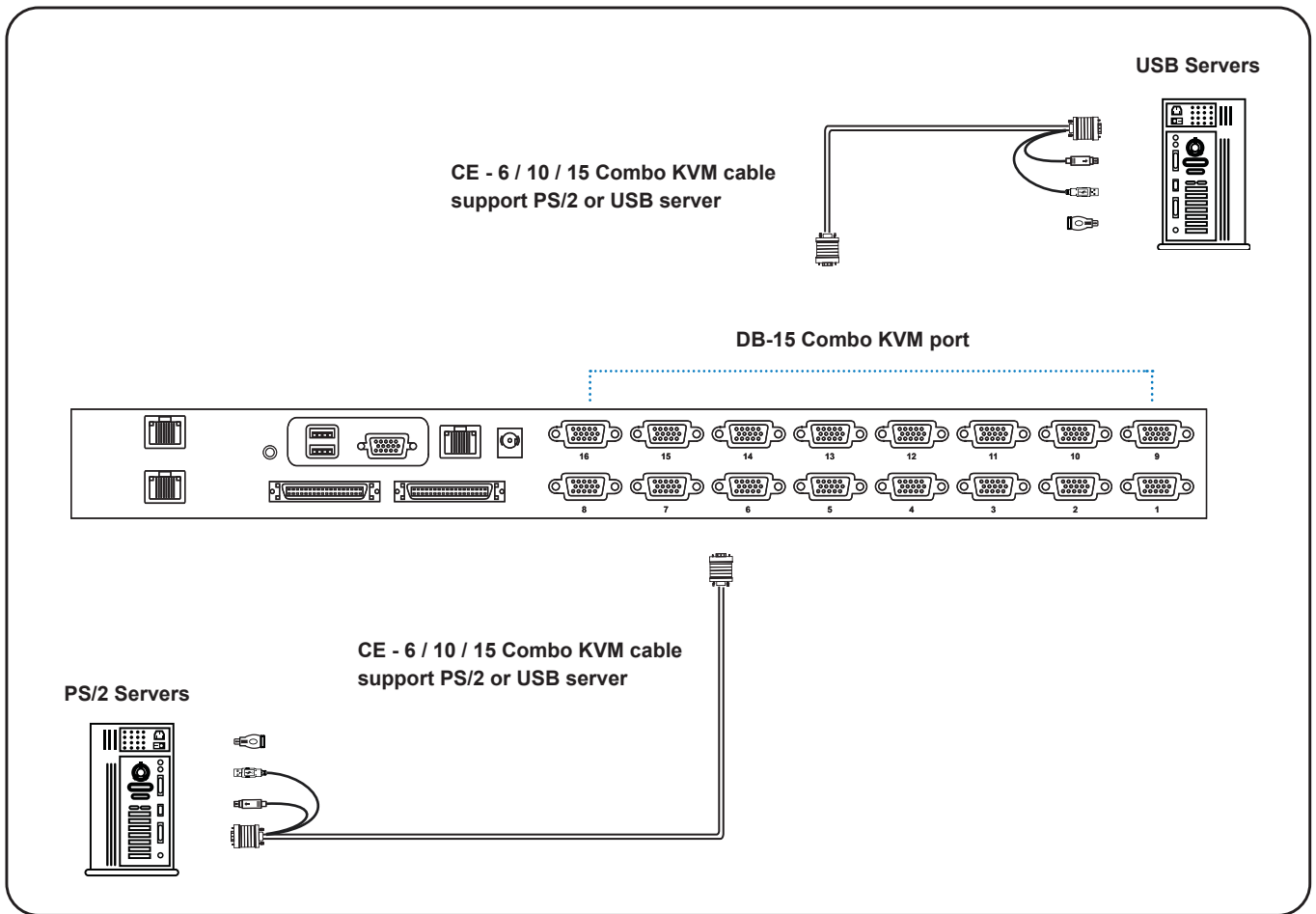

CE-6 / CE-10 / CE-15

- 6 / 10 / 15 ft Combo KVM cable
- Support PS/2 or USB server



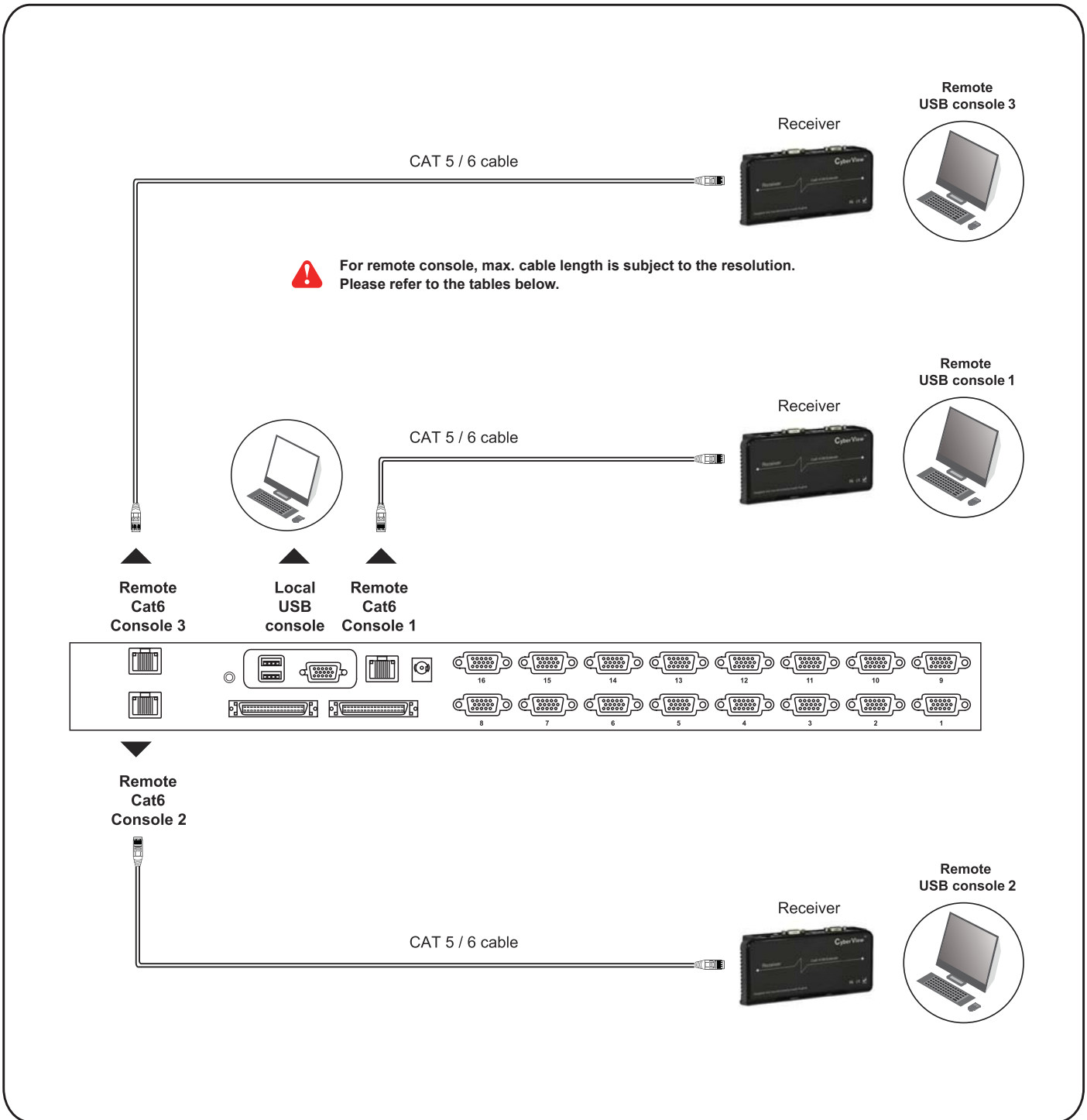

Remote Console

Resolution Support	Frequency (Hz)	Max. Cat6 Cable Length (M)
1920 x 1200	60	50
1920 x 1080	60	50
1600 x 1200	60	100
1440 x 900	60	100
1280 x 1024	60	150

Receiver

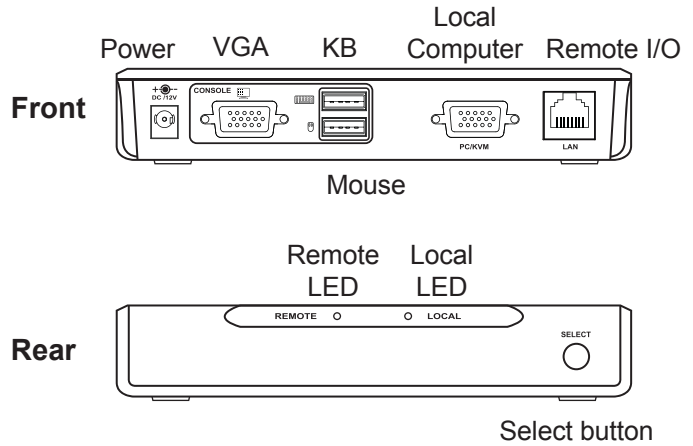

The receiver provides a hotkey function for remote console. Please refer to P.21

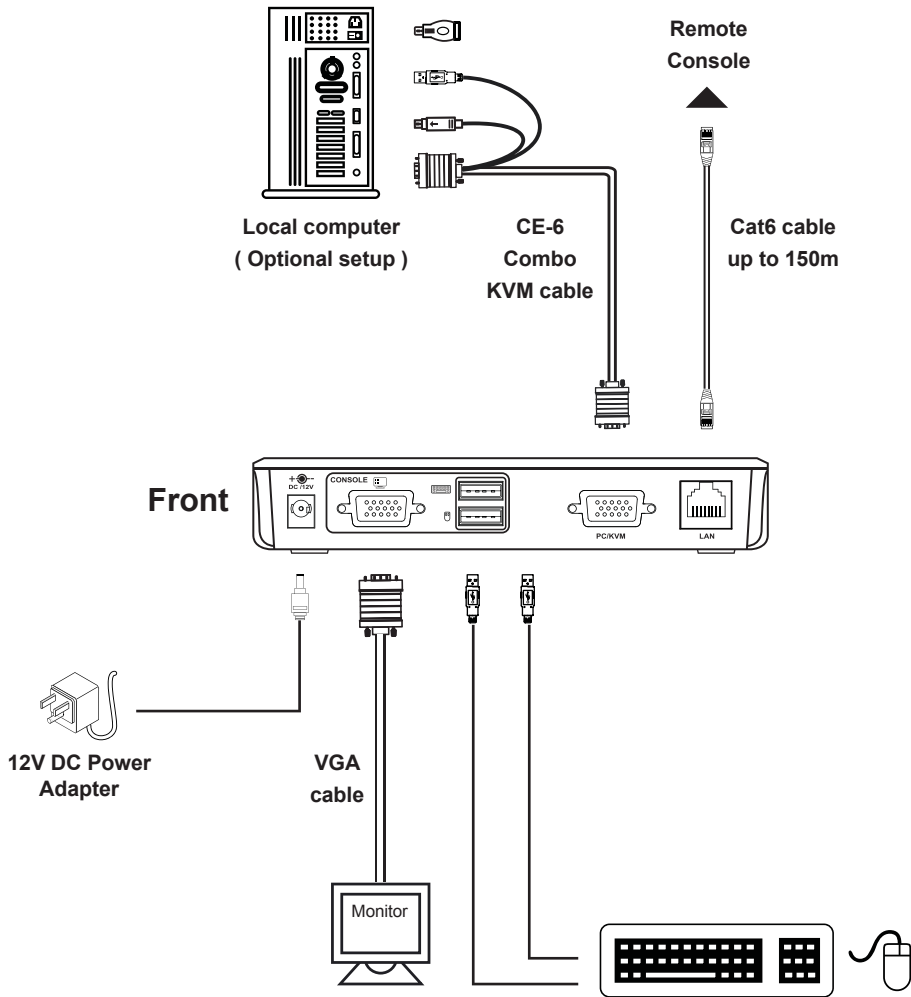
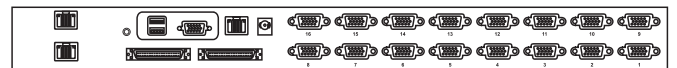

< 2.4 > KVM Cascade

Matrix DB-15 KVM

- Cascade up to 8 levels, 240 servers
- Cascading multiple KVM with CMC-8 cascade cable.

! Cascaded KVMs from level 2 to 8 must be the models of M-802 / M-1602 or MU-1602 / MU-3202.

! When multiple matrix KVMs cascade together, the master KVM at level 1 will take all control of other slave KVM switches (e.g. level 2 to 8).

! The slave matrix KVM will be as a port expansion module of the master matrix KVM, the original remote console on slave KVM will be sacrificed and disabled.

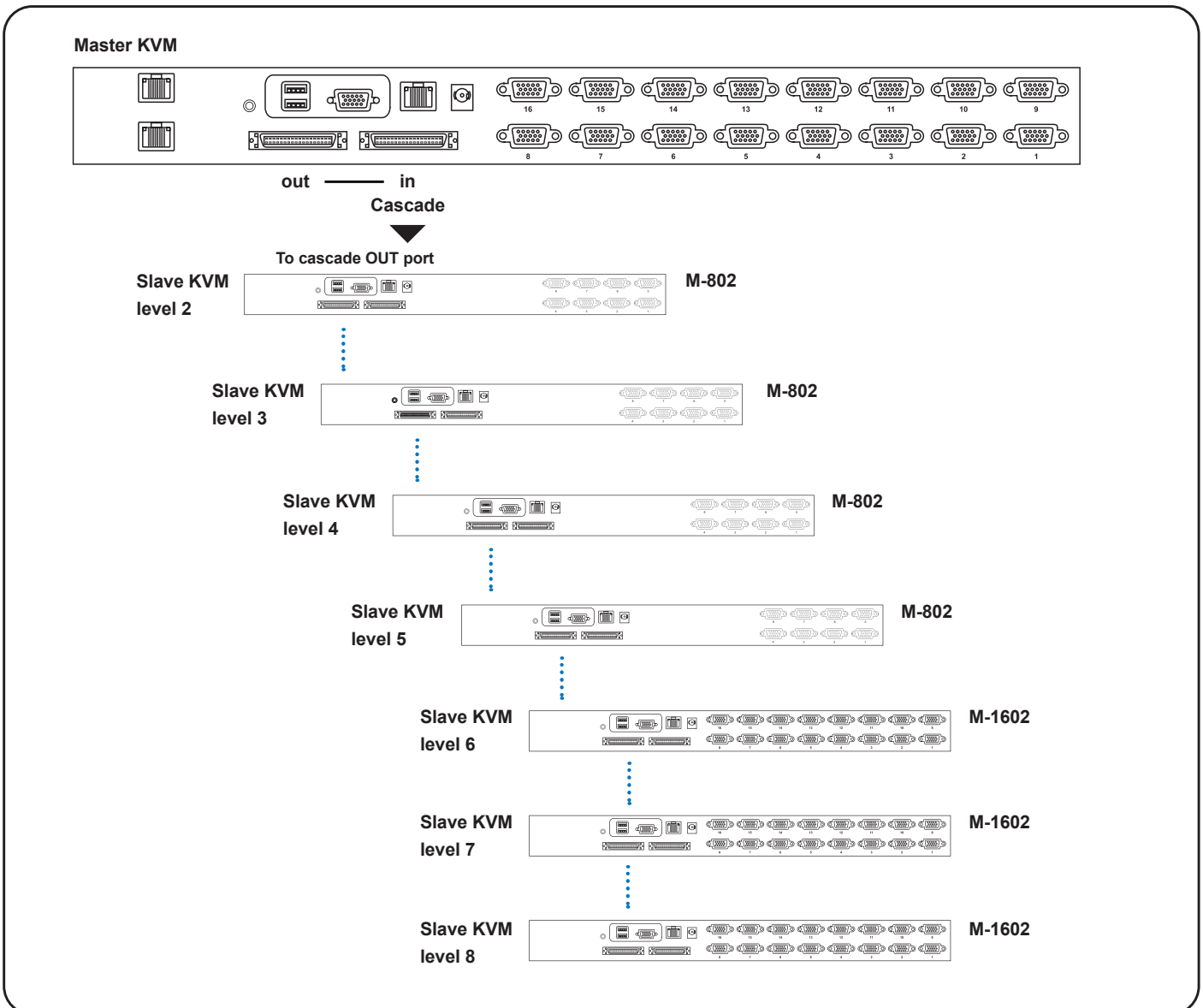

CMC-8

- 8ft Matrix KVM cascade cable

	M-802 M-1602	M-803 M-1603	M-804 M-1604
<p>■ KVM Port</p> <p>Number of ports : 8 or 16</p> <p>Connector : DB-15 combo connector</p> <p>Connectivity : Combo 4-in-1 KVM cable up to 6, 10 & 15 feet</p>			
<p>■ Local Console</p> <p>Monitor port : 1 x DB-15 VGA</p> <p>Keyboard & mouse port : 2 x USB type connector for keyboard & mouse</p> <p>Resolution support : 4:3 - max. 1600 x 1200, 16:10 - max. 1920 x 1200</p>			
<p>■ Cat6 Remote Console</p> <p>Number of remote port : 1 for M-802 / M-1602 2 for M-803 / M-1603 3 for M-804 / M-1604</p> <p>Monitor port : DB15-pin VGA</p> <p>Keyboard & mouse port : 2 x USB type connector for keyboard & mouse</p> <p>Remote I/O : RJ45 via Cat5 / Cat5e / Cat6 cable up to 500 feet</p> <p>Resolution support : 4:3 - max. 1600 x 1200, 16:10 - max. 1920 x 1200</p>			
<p>■ Expansion :</p> <p>Up to 240 servers by 8-level cascade</p>			
<p>■ Compatibility</p> <p>Hardware : HP / IBM / Dell PC, Server and Blade Server SUN / Mac</p> <p>OS Support : Windows / Linux / Unix / Mac OS</p>			
<p>■ Power</p> <p>Input : AC power adapter</p> <p>Consumption : Max. 16W</p>			
<p>■ Regulatory</p> <p>Safety : cUL, FCC & CE certified</p> <p>Environment : RoHS2 & REACH compliant</p>			
<p>■ Environmental</p> <p>Temperature : 0 to 55°C degree</p> <p>Humidity : 20~90%, non-condensing</p> <p>Altitude : 16,000 ft</p> <p>Shock : -</p> <p>Vibration : -</p>	<p>Operating</p> <p>0 to 55°C degree</p> <p>20~90%, non-condensing</p> <p>16,000 ft</p> <p>-</p> <p>-</p>	<p>Storage / Non-operating</p> <p>-20 to 60°C degree</p> <p>5~90%, non-condensing</p> <p>40,000 ft</p> <p>10G acceleration (11ms duration)</p> <p>5~500Hz 1G RMS random</p>	
<p>■ Product Information</p> <p>Dimension (W x D x H) : 443 x 171 x 44 mm / 17.4 x 6.7 x 1.73 inch</p> <p>Net weight: 3 kg / 6.5 lb</p>			
<p>■ Packing Information</p> <p>Dimension (W x D x H) : 500 x 400 x 90 mm / 19.7 x 15.7 x 3.5 inch</p> <p>Gross weight: 5 kg / 11 lb</p>			

3.1 KVM Button

Power ON

- Turn off all servers and KVM switches
- Make sure all cables / connectors are properly connected
- Recommend Power ON sequence is monitor, KVM switch finally computer

Front Panel - Port LED Indications

8 ports

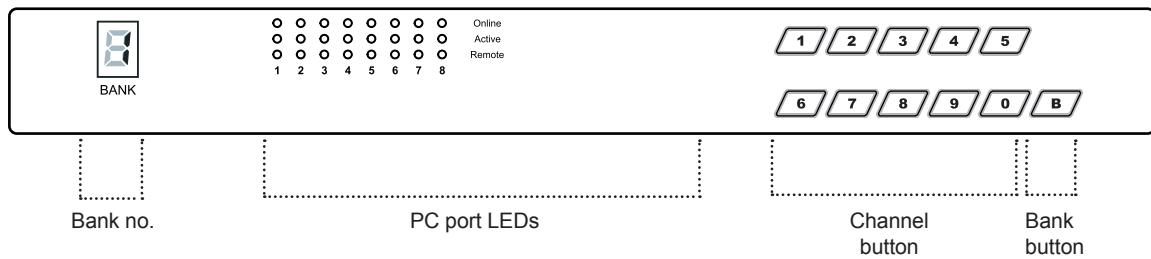

16 ports

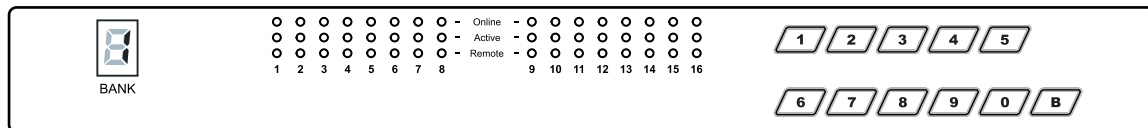

Bank no.	7-Segment BANK LED indication
PC port LEDs	<p>Online : Blue LED on indicating a PC is connecting to the port</p> <p>Active : Green LED on indicating a selected channel</p> <p>Remote : Orange LED on indicating the port is selecting by IP / remote console</p>
Channel button	Press to select channel from 01 to 16
Bank button	Select the bank from 1 to 8

The password is enabled by default, the default password is “00000000” eight zeros (**Do not use “0” on number pad**)

■ Enable password

1. Press the KVM hotkey **Scroll Lock + Scroll Lock + U**
2. Logout the KVM by pressing the hotkey **Scroll Lock + Scroll Lock + P**
3. In SUPERVISOR level, enter “00000000” eight zeros in user name & password field (**Do not use “0” on number pad**)
4. In USER level, press **Space bar + Enter** in user name & password field
Remark: Automatic logout after 10 minutes of inactivity

■ Set your own user name & password

1. Login the KVM in SUPERVISOR level by pressing “00000000” eight zeros in user name & password field
2. Call KVM OSD menu by pressing the KVM hotkey **Scroll Lock + Scroll Lock + Space Bar**
3. Press **F1** to the MAIN MENU
4. Select “USER SECURITY”
5. Set password in SUPERVISOR & USER level
 - a. In the left-top row “S” (SUPERVISOR), press **Enter** to set your own user name & password
 - b. In the row 1 to 8 (USER), press **Enter** to set your own user name & password
6. Press **Enter** to save the setting or press **Esc** to cancel the editing without any change
Remark: a. Blank has underscore, while SPACE doesn't have
 - b. Press any alphanumeric key to move to next input item. SPACE is treated as a valid character

■ Change your password

1. Login the KVM in SUPERVISOR level by pressing your own user name & password
2. Call KVM OSD menu by pressing the KVM hotkey **Scroll Lock + Scroll Lock + Space Bar**
3. Press **F1** to the MAIN MENU
4. Select “USER SECURITY”
5. Change password in SUPERVISOR & USER level
 - a. In the left-top row “S” (SUPERVISOR), press **Enter** to change your user name & password
 - b. In the row 1 to 8 (USER), press **Enter** to change your user name & password
6. Press **Enter** to save the setting or press **Esc** to cancel the editing without any change
Remark: a. Blank has underscore, while SPACE doesn't have
 - b. Press any alphanumeric key to move to next input item. SPACE is treated as a valid character

■ Disable your password

1. Press the KVM hotkey **Scroll Lock + Scroll Lock + U**
2. Logout the KVM by pressing the KVM hotkey **Scroll Lock + Scroll Lock + P**
3. You don't need user name & password to access the KVM OSD menu

■ Forget your password

Please contact your supplier for further support



Remark:

- You must press the KVM hotkey within 2 seconds
- A beep sound will be heard for successful entering KVM hotkey

OSD Menu

PORT NAME	
BANK : 1	
01☼ SYSTEM 01	F1 : MENU
02☼ SYSTEM 02	F2 : LOGOUT
03☼ SYSTEM 03	F3 : PREV
04☼ SYSTEM 04	ESC : QUIT
05☼ SYSTEM 05	ENTER : COMPLETE
06☼ SYSTEM 06	↑/↓ : SELECT
07☼ SYSTEM 07	PgUp/PgDn : BANK SELECT
08☼ SYSTEM 08	
USER : SUPERVISOR	
SCAN TIME : 10 SEC FW1V3	

OSD operation

 next to the system name	The PC is powered on
 next to the system name	The PC is selected
F1	Access F1 MAIN MENU
F2	Logout the OSD menu
F3	Previous menu
Esc	Cancel / Quit
Enter	Complete / Switch to selected port
↑/↓	Switch to previous or next port
PgUp/PgDn	Switch to previous bank or next bank
1 / 2 / 3 / 4	Display port 01 ~ 08 / 09 ~ 16 / 17 ~ 24 / 25 ~ 32 Remark: Display port 17 ~ 32 for 32 port model only

F1 Main Menu

MAIN MENU	
SELECT OPTION :	
01	LANGUAGE
02	PORT NAME EDIT
03	PORT SEARCH
04	USER SECURITY
05	ACCESS LIST
06	HOTKEY
07	TIME SETTINGS
08	OSD MOUSE

01 LANGUAGE	OSD language change
02 PORT NAME EDIT	Define port name
03 PORT SEARCH	Quick searching by port name
04 USER SECURITY	Change password
05 ACCESS LIST	Define user access authority
06 HOTKEY	Change hotkey
07 TIME SETTINGS	Modify scan display time interval
08 OSD MOUSE	Modify OSD mouse speed

Local Console Hotkey	Function
Scroll Lock + Scroll Lock + Space Bar	Calling OSD menu
Right-button mouse + Esc	Calling OSD menu
Scroll Lock + Scroll Lock + ↑	Switch to previous port
Scroll Lock + Scroll Lock + ↓	Switch to next port
Scroll Lock + Scroll Lock + PgUp / PgDn	Switch to previous bank or next bank
Scroll Lock + Scroll Lock + Bank no. + Port no.	Switch to specific port
Scroll Lock + Scroll Lock + B	Turn the buzzer ON and OFF * Default the buzzer is ON
Scroll Lock + Scroll Lock + P	Logout the KVM if password security is ON. Show up the status windows

Advance hotkeys (for Supervisor login only)

Scroll Lock + Scroll Lock + S	Activate auto-scan mode for connected servers *Press any key to exit the auto-scan mode
Scroll Lock + Scroll Lock + R	Reset all the KVM settings to factory default *Except User Security settings
Scroll Lock + Scroll Lock + U	Disable and enable password security *Default security is ON
Scroll Lock + Scroll Lock + L	To enable / disable the screen saving function and 10 minutes auto-logout *Default the screen saving is OFF

Remarks: ■ Example of “Scroll Lock + Scroll Lock + Bank no. + Port no.”

- Bank No. : 1 to 8
- Port No. : 01 to 16
- e.g. Bank 1 Port 4 : **Scroll Lock + Scroll Lock + 1 + 0 + 4**
- e.g. Bank 2 Port 16 : **Scroll Lock + Scroll Lock + 2 + 1 + 6**

- You must press the hotkey within 2 seconds
- A beep sound will be heard for successful entering
- The numeric keypad is not supported, while in OSD screen, the arrow keys, PgUp, PgDn, and Enter keys are supports

Remote Console Hotkey	Function
Scroll Lock + Scroll Lock + C	Toggle switch between remote & local port
Scroll Lock + Scroll Lock + Q	Turn the buzzer ON & OFF *Default the buzzer is ON
Scroll Lock + Scroll Lock + S	Activate auto-scan mode for remote & local port *The scan time interval is 5 seconds
Scroll Lock + Scroll Lock + A	Auto-adjust the video signal

The company reserves the right to modify product specifications without prior notice and assumes no responsibility for any error which may appear in this publication.

All brand names, logo and registered trademarks are properties of their respective owners.

Copyright 2018 Austin Hughes Electronics Ltd. All rights reserved.