

## User Manual 19" LCD



### RP-919QD 9U Quad Display

Options :  
- DC power



Designed and manufactured by Austin Hughes

751

## Legal Information

First English printing, July 2022

Information in this document has been carefully checked for accuracy; however, no guarantee is given to the correctness of the contents. The information in this document is subject to change without notice. We are not liable for any injury or loss that results from the use of this equipment.

## Safety Instructions

**Please read all of these instructions carefully before you use the device. Save this manual for future reference.**

- Unplug equipment before cleaning. Don't use liquid or spray detergent; use a moist cloth.
- Keep equipment away from excessive humidity and heat. Preferably, keep it in an air-conditioned environment with temperatures not exceeding 40° Celsius (104° Fahrenheit).
- When installing, place the equipment on a sturdy, level surface to prevent it from accidentally falling and causing damage to other equipment or injury to persons nearby.
- When the equipment is in an open position, do not cover, block or in any way obstruct the gap between it and the power supply. Proper air convection is necessary to keep it from overheating.
- Arrange the equipment's power cord in such a way that others won't trip or fall over it.
- If you are using a power cord that didn't ship with the equipment, ensure that it is rated for the voltage and current labeled on the equipment's electrical ratings label. The voltage rating on the cord should be higher than the one listed on the equipment's ratings label.
- Observe all precautions and warnings attached to the equipment.
- If you don't intend on using the equipment for a long time, disconnect it from the power outlet to prevent being damaged by transient over-voltage.
- Keep all liquids away from the equipment to minimize the risk of accidental spillage. Liquid spilled on to the power supply or on other hardware may cause damage, fire or electrical shock.
- Only qualified service personnel should open the chassis. Opening it yourself could damage the equipment and invalidate its warranty.
- If any part of the equipment becomes damaged or stops functioning, have it checked by qualified service personnel.

## What the warranty does not cover

- Any product, on which the serial number has been defaced, modified or removed.
- Damage, deterioration or malfunction resulting from:
  - Accident, misuse, neglect, fire, water, lightning, or other acts of nature, unauthorized product modification, or failure to follow instructions supplied with the product.
  - Repair or attempted repair by anyone not authorized by us.
  - Any damage of the product due to shipment.
  - Removal or installation of the product.
  - Causes external to the product, such as electric power fluctuation or failure.
  - Use of supplies or parts not meeting our specifications.
  - Normal wear and tear.
  - Any other causes which does not relate to a product defect.
- Removal, installation, and set-up service charges.

## Regulatory Notices Federal Communications Commission (FCC)

This equipment has been tested and found to comply with the limits for a Class B digital device, pursuant to Part 15 of the FCC rules. These limits are designed to provide reasonable protection against harmful interference in a residential installation.

Any changes or modifications made to this equipment may void the user's authority to operate this equipment. This equipment generates, uses, and can radiate radio frequency energy and, if not installed and used in accordance with the instructions, may cause harmful interference to radio communications.

However, there is no guarantee that interference will not occur in a particular installation. If this equipment does cause harmful interference to radio or television reception, which can be determined by turning the equipment off and on, the user is encouraged to try to correct the interference by one or more of the following measures:

- Re-position or relocate the receiving antenna.
- Increase the separation between the equipment and receiver.
- Connect the equipment into an outlet on a circuit different from that to which the receiver is connected.

# Contents

<b>&lt; Part. 1 &gt;</b>	<b>RP-W919QD</b>	
1.1	Package Content	P.1
1.2	Structure Diagram & Dimension	P.1
1.3	Installation	P.2
<b>&lt; Part. 2 &gt;</b>	<b>Specifications / OSD</b>	
2.1	Product Specifications	P.5
2.2	On-screen Display Operation ( OSD )	P.6
<b>&lt; Part. 3 &gt;</b>	<b>Options</b>	
3.1	DC Power : 12V / 24V / 48V / 125V / 250V	P.9
<b>&lt; Part. 4 &gt;</b>	<b>Quad Display Connection &amp; Operation</b>	
4.1	QD Connection	P.10
4.2	QD ALARM Connection & Operation	P.11
4.3	QD Remote Control Connection & Operation	P.13
4.4	QD OSD Operation	P.18
4.5	QD On-screen Menu	P.19
4.6	QD VCR Operation	P.22
4.7	QD Specification	P.22

## < Part 1 >

### < 1.1 > Package Content



#### RP-919QD unit X 1

- 6ft VGA cable X 1
- Power adapter X 1
- Power cord X 1

### < 1.2 > Structure Diagram

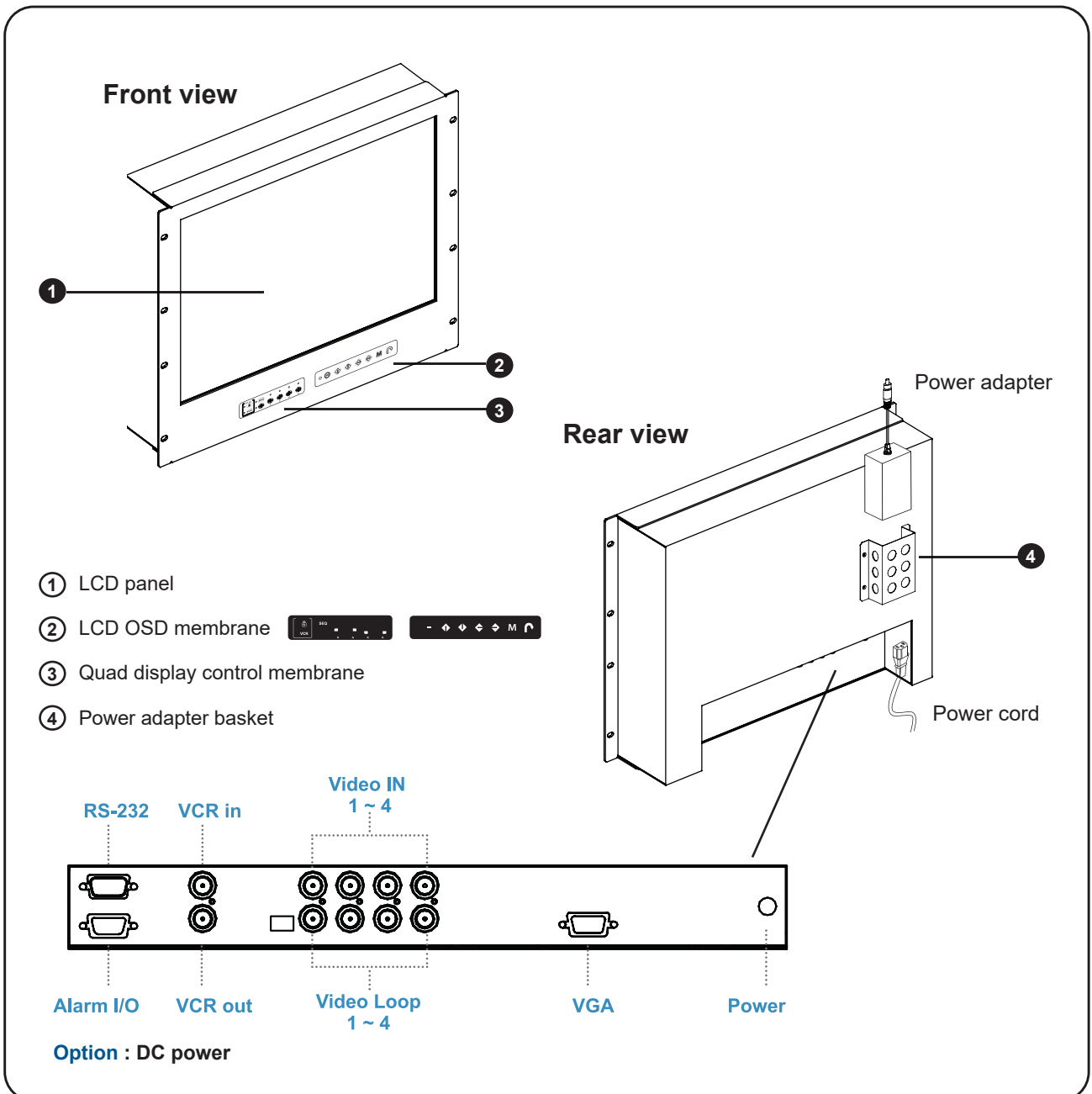

< 1.2 > Dimension

RP-919QD

Front View

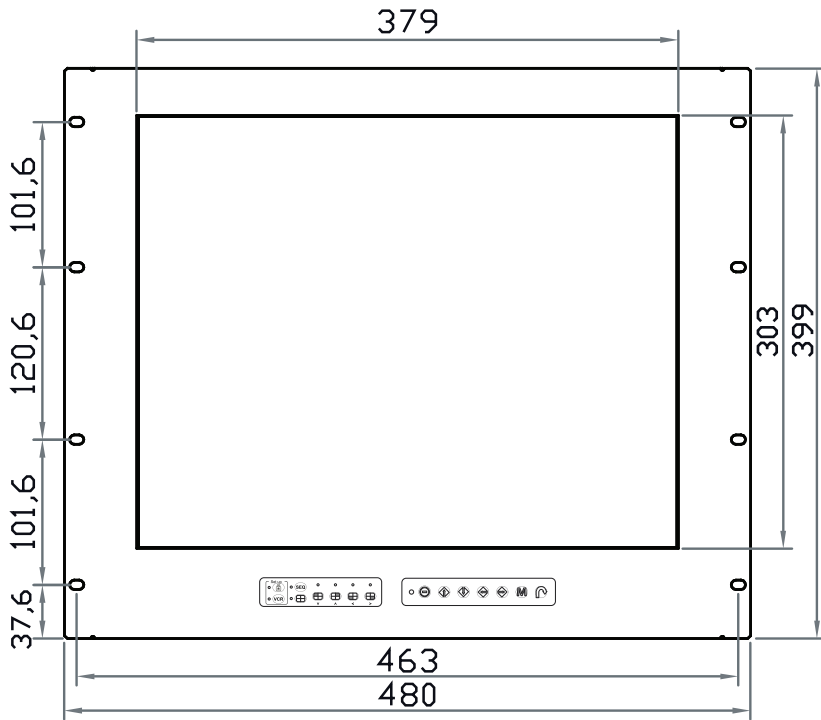

Side View

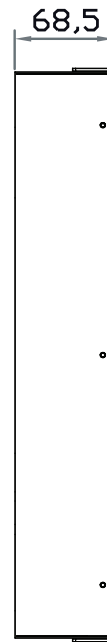

UNIT : mm  
1mm = 0.03937 inch

Bottom View

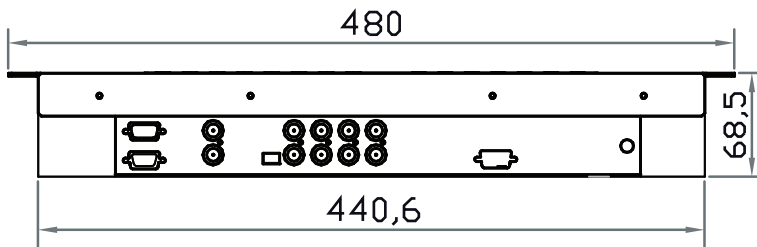

Model	Product Dimension (W x D x H)	Packing Dimension (W x D x H)	Net Weight	Gross Weight
RP-919QD	480 x 68.5 x 399 mm 18.9 x 2.7 x 15.7 inch	583 x 124 x 529 mm 23 x 4.9 x 20.8 inch	9.5 kg 20.9 lb	12.5 kg 27.5 lb

## < 1.3 > Installation

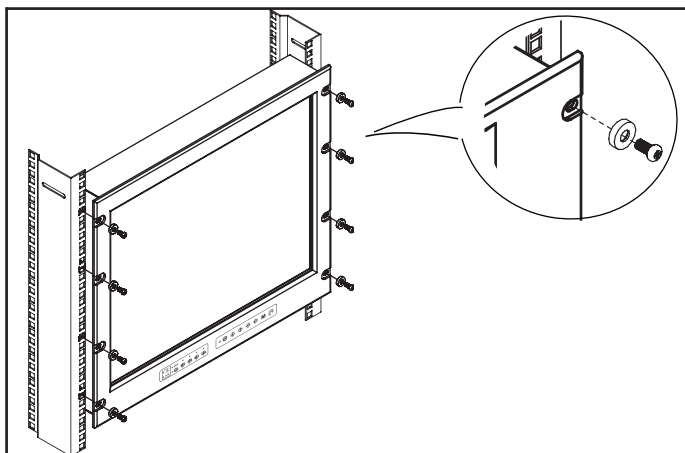

### Step 1

- Mount the display panel with M6 screw set.
- M6 screw x 8 pcs required ( Left & right side ).

**M6 screw sets are not provided.**

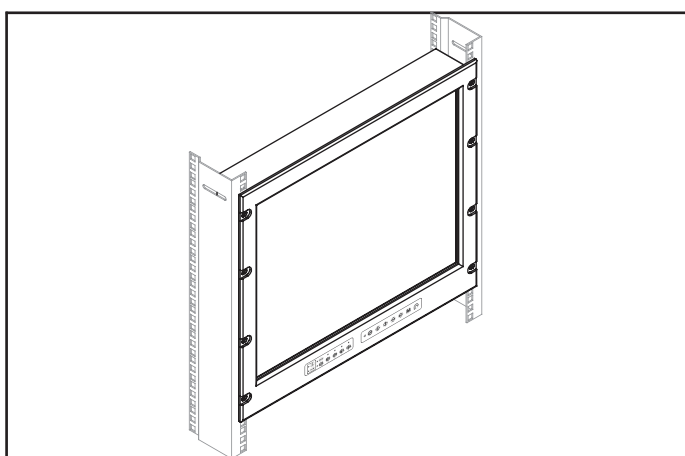

### Step 2

- Fix the LCD into the rack.

# Intentionally Left Blank

## < Part 2 >

### < 2.1 > Product Specifications

<b>LCD Panel</b>	Manufacturer	<b>AUO</b>
	Panel Size ( diagonal )	19-inch TFT color LCD
	Display pixel ( dots x lines )	1280 x 1024
	Brightness ( typ. )	250
	Contrast Ratio ( typ. )	1000:1
	Color	16.7 M
	Viewing Angle ( L/R/U/D )	85/85/80/80
	Response Time ( ms )	5
	Dot pitch ( mm )	0.294
	Display Area ( mm )	376.32H x 301.06V
	Surface treatment	Haze 25%, Hard-coating
	Surface hardness	3H
	Backlight Type	LED
	MTBF ( hrs )	30,000

<b>Video Connectivity</b>	Analog	VGA	Analog 0.7Vp-p
---------------------------	--------	-----	----------------

<b>Power</b>	Power Supply	Range	Auto-sensing 100 to 240VAC, 50 / 60Hz
	Power Consumption	Screen ON	Max. 22W
		Power saving mode	Max. 2W
		Power button OFF	Max. 1W

<b>Compliance</b>	EMC	FCC & CE
	Safety	CE / LVD & UKCA
	Environmental	RoHS3 & REACH / WEEE

<b>Environmental Conditions</b>	Operating	Temperature	0 to 55°C degree
		Humidity	10~90%, non-condensing
		Altitude	16,000 ft
	Storage / Non-operating	Temperature	-20 to 60°C degree
		Humidity	5~90%, non-condensing
		Altitude	40,000 ft
		Shock	10G acceleration (11ms duration)
		Vibration	10~300Hz 0.5G RMS random











<b>Physical Specification</b>	Product ( W x D x H )	480 x 68.5 x 399 mm 18.9 x 2.7 x 15.7 inch
	Packing ( W x D x H )	583 x 124 x 529 mm 23 x 4.9 x 20.8 inch
	Net Weight	9.5 kg / 20.9 lb
	Gross Weight	12.5 kg / 27.5 lb

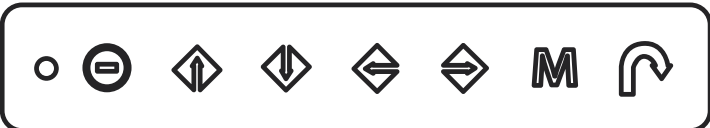







\* All dimensions stated are subject to change if options are selected / integrated to base model part codes







<b>Applicable Format</b>	DVI-D / VGA Input	PC Signal	1280 x 1024 x 60 / 75Hz
			1280 x 960 x 60Hz
			1280 x 768 x 60 / 75Hz
			1152 x 864 x 75Hz
			1024 x 768 x 60 / 70 / 75Hz
			848 x 480 x 60Hz
			800 x 600 x 60 / 72 / 75Hz
			720 x 400 x 70Hz
			640 x 480 x 60 / 72 / 75Hz
			640 x 400 x 70Hz
640 x 350 x 70Hz			

## < 2.2 > On-screen Display Operation ( OSD )

- Power light
- Green = On
- Orange = Power saving

Membrane Switch	Function
	Power on / off LCD
	Display the OSD menu
   	Scrolls through menu options and adjusts the displayed control (To auto adjustment by pressing the button  for 5 seconds)
	Exit the OSD screen Toggle analog, digital & video connection (DVI-D and video options only)

- ① All the LED touch buttons will automatically turn off after 10 minutes of idle status ( except the **Power**  ).
- ② Light up all membrane buttons, please press any button for 1 - 2 seconds ( except the **Power**  ).
- ③ Select another video input (only available for models with multiple video input) :
  - ( a ) Press the button  to call up the on-screen video mode on top right corner.
  - ( b ) Use up/down arrow   to the select the video input
  - ( c ) Press the button  to confirm the selection

## < 2.2 > On-screen Display Operation ( OSD )

### ① Picture

Brightness : Adjust the screen brightness

Contrast : Adjust the difference between the image background ( black level ) and the foreground ( white level )

Black level : Adjust background black level of the screen

Eco : Screen in power saving mode

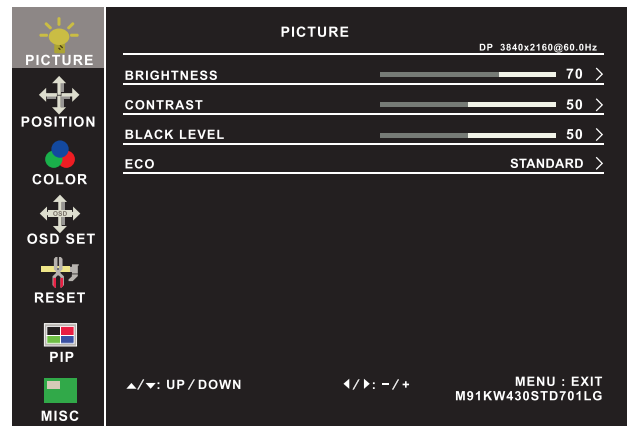

### ② Position

Picture size : Adjust the image size  
- Full Screen / 4:3 / 5:4 / Pixel to Pixel

DP version : Select the DP version

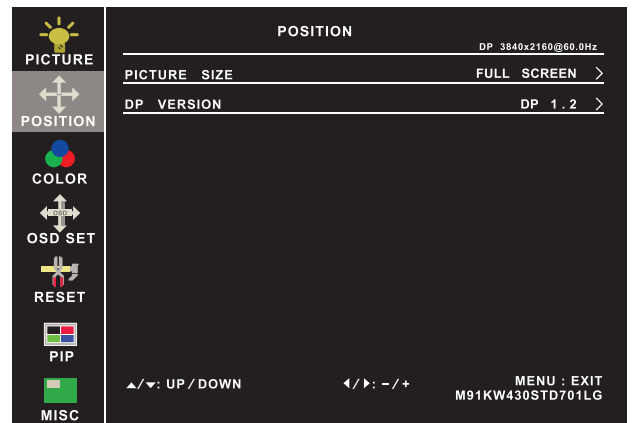

### ③ Color

Color temperature : User / Warm / Cool / 5400k mode and Red / Green / Blue color balance

Sharpness : Adjust the image from weak to sharp

Hue : Adjust the screen hue value

Saturation : Adjust the saturation of the image color

Dynamic

luminous control : Control the dynamic brightness

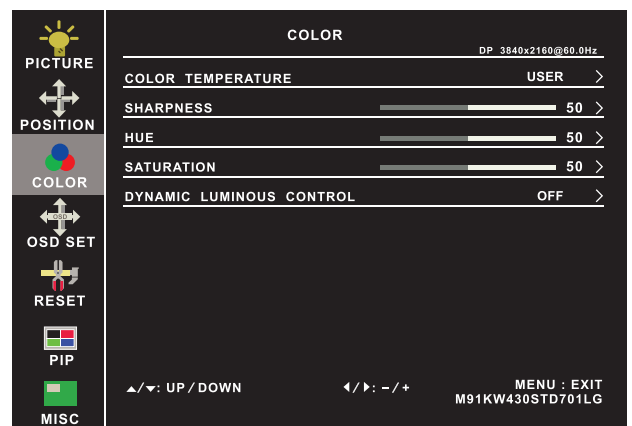

### ④ OSD Set

Language : Select the language in which the OSD menu is displayed - English

OSD H-Position : Align the screen image left or right

OSD V-Position : Align the screen image up or down

OSD time out : Adjust the screen timeout

OSD transparency : Adjust the screen transparency

OSD size : Adjust the screen size - Normal / Small

OSD rotation : Rotate the screen - 90° / 180° / 270°

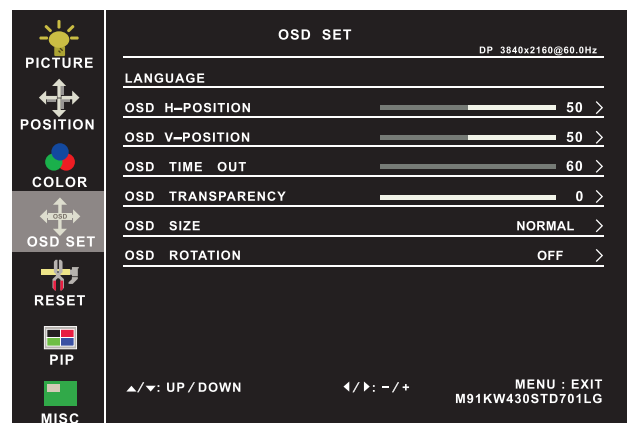

## < 2.2 > On-screen Display Operation ( OSD )

RP-919QD

### ⑤ Reset

Reset : Return the adjustment back to factory setting

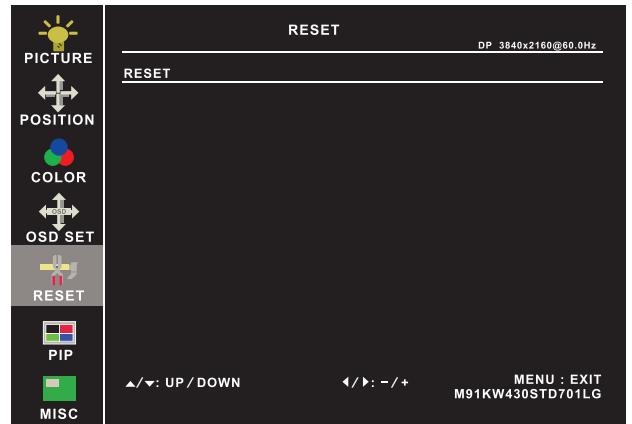

### ⑥ PIP ( Not Applicable to F17 / MF17 )

PIP mode : Enter into PIP / PBP setting - PIP MODE / PBP 2WIN ( Main screen + 1 sub screen ) / PBP 3WIN ( Main screen + 2 sub screen ) / PBP 4WIN ( Main screen + 3 sub screen )  
Select the signal input of each sub screen

PIP size : Adjust the size of the Sub screen  
- Small / Medium / Large / Huge

PIP position : Adjust the position of the Sub screen  
- Top Left / Top Right / Bottom Left / Bottom Right

Swap : Swap the input signal of PIP / PBP sub screen

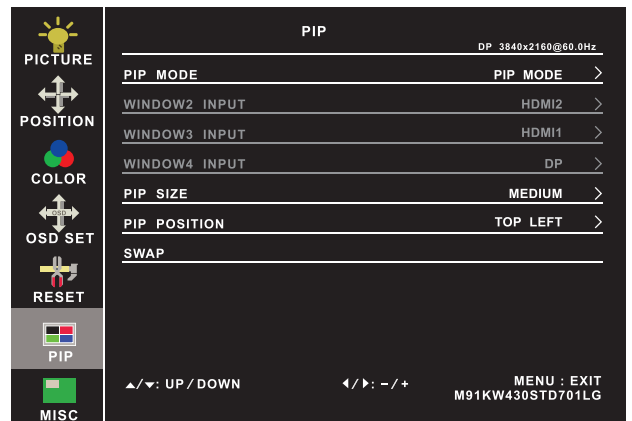

### ⑦ MISC

Signal source : Select the signal source - DP / HDMI1 / HDMI2

Mute : Turn off the surrounding sound

Audio in : Auto / Line in / DP

Volume : Adjust the volume of sound

Sleep mode : Set the off time - 10 min / 20 min / 30 min / 50 min / 60 min / 120 min / 240 min

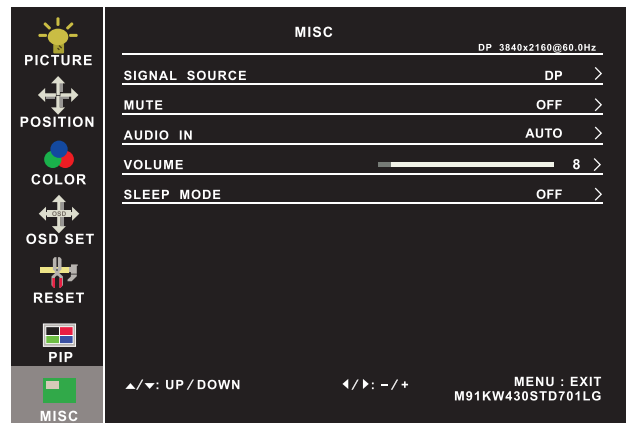

### Options on Reset page

Rotation : Rotate the image in Full screen or 1:1  
- 90° / 180° / 270°

Picture size : Adjust the image size in Full screen or 1:1

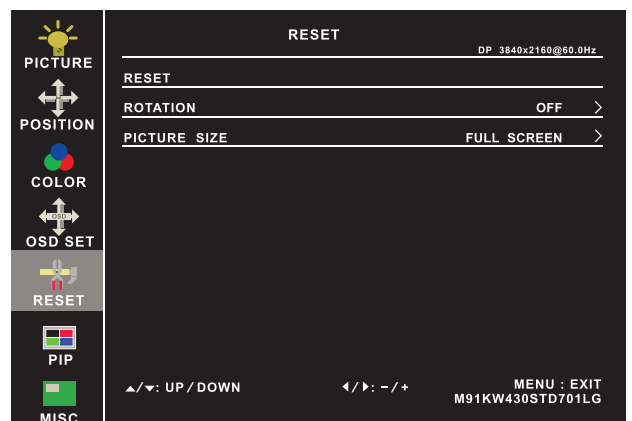

### < Part 3 >

### < 3.1 > Options : DC Power

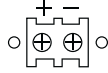

Model	12V	24V	48V	125V	250V
<b>Input rating</b>					
Input voltage:	12-Volt	24-Volt	48-Volt	110-Volt	300-Volt
Input range:	9 ~ 18V	18 ~ 36V	36 ~ 75V	66 ~ 160V	180 ~ 425V
Input current					
- No load	50 mA	50 mA	50 mA	35 mA	10 mA
- Full load	4950 mA	2450 mA	1220 mA	749 mA	600 mA
<b>Output rating</b>					
Output voltage:	12-Volt	12-Volt	12-Volt	12-Volt	12-Volt
Output current:	4.16A	4.16A	4.16A	6.25A	12.5A
<b>Efficiency</b>	84%	85%	85%	91%	86%

\*\*\* For DC power option :

( 1 ) If the unit with LCD, **earthing** may be required

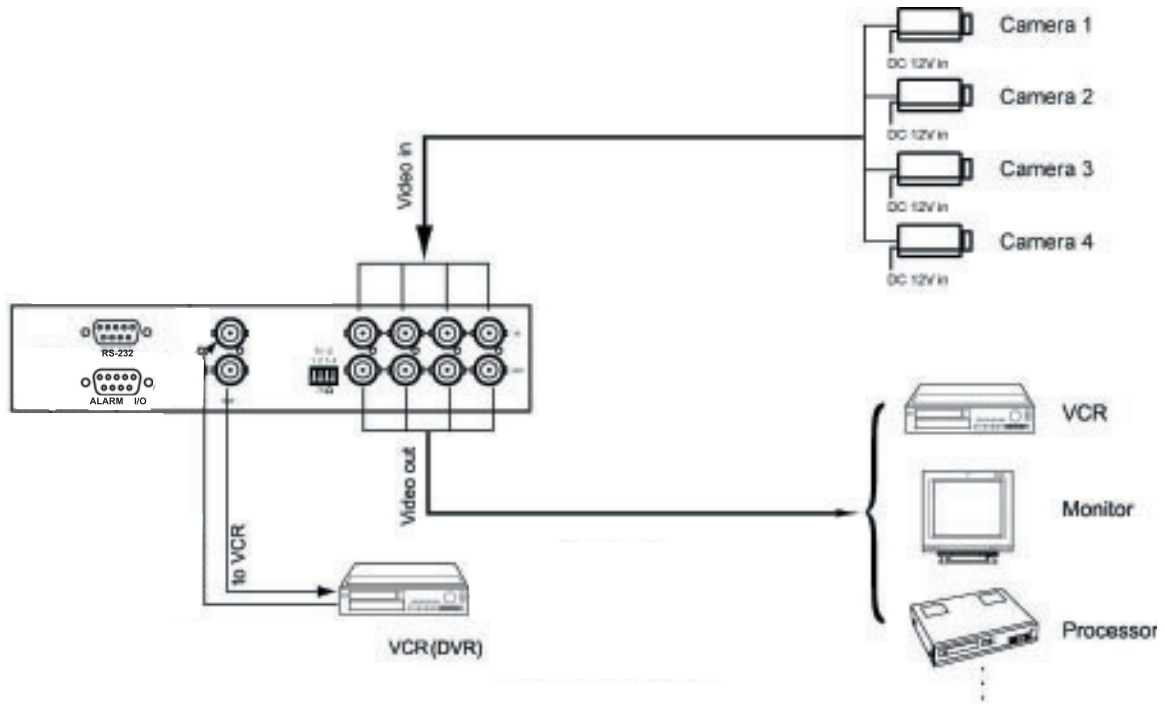

**1. VCR in :**

This BNC connector is connected to video output from VCR/DVR. A pre-recorded quad screen signal from a tape can be played back through a VCR/DVR and displayed on the video output channels. Push the VCR button (#2) to switch the device to VCR Playback mode.

**2. VCR out :**

This BNC connector is to be connected to the Video in from your VCR/DVR. It will only provide a quad screen video to ensure an un-interrupted video recording for all four cameras. The display video is not affected by the control panel.

**3. Terminations :**

These impedance switches are used to provide proper termination for each camera input. These switches toggle between 75Ω and Hi-Z impedance. Incorrect termination will degrade the quality of the video signal. All video inputs not “looped through” to another device, the corresponding switches need to be set to 75Ω termination position. If another device is connected to video out loop through connector set the corresponding termination switch to Hi-Z position. Any device connected to the video out loop through connectors needs to be configure to 75Ω video termination. The factory default termination setting is 75Ω.

**4. Ch1 In, Ch2 In, Ch3 In, and Ch4 In Video IN connectors :**

These BNC connectors are used to connect to the video out from camera. Four cameras can be connected to these connectors to form a quad screen in the following mapping order.

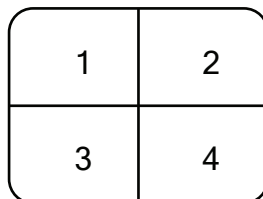

**5. Ch1 Out, Ch2 Out, Ch3 Out, and Ch4 Out Video Loop through connectors :**

These connectors are used to loop video signals from each camera out to other devices.

## < 4.2 > QD ALARM Connection & Operation

### 1. ALARM I/O :

This female type 9 pin D-sub connector is used for alarm sensor input and alarm output control connections. It provides Normal Open and Normal Close contacts for alarm out control.

Pin Assignment for Alarm Connector (female type)					
PIN#		PIN#		PIN#	
1	Sensor 1	4	Sensor 4	7	Normal Open Contact
2	Sensor 2	5	Reset In	8	Common Contact
3	Sensor 3	6	GND	9	Normal Close Contact

The Alarm Hold Time can be configured from 0 second to 99 minutes through system Setup menu.

### 2. VCR Connection for Tape Recording Start and Stop Control :

Connecting the contacts of VCR RECORD and STOP switch to the alarm output NC and NO contacts will allow you to use an ordinary VCR to record for longer period of time. Combined with alarm sensor detection, the VCR will record only when an alarm sensor is activated.

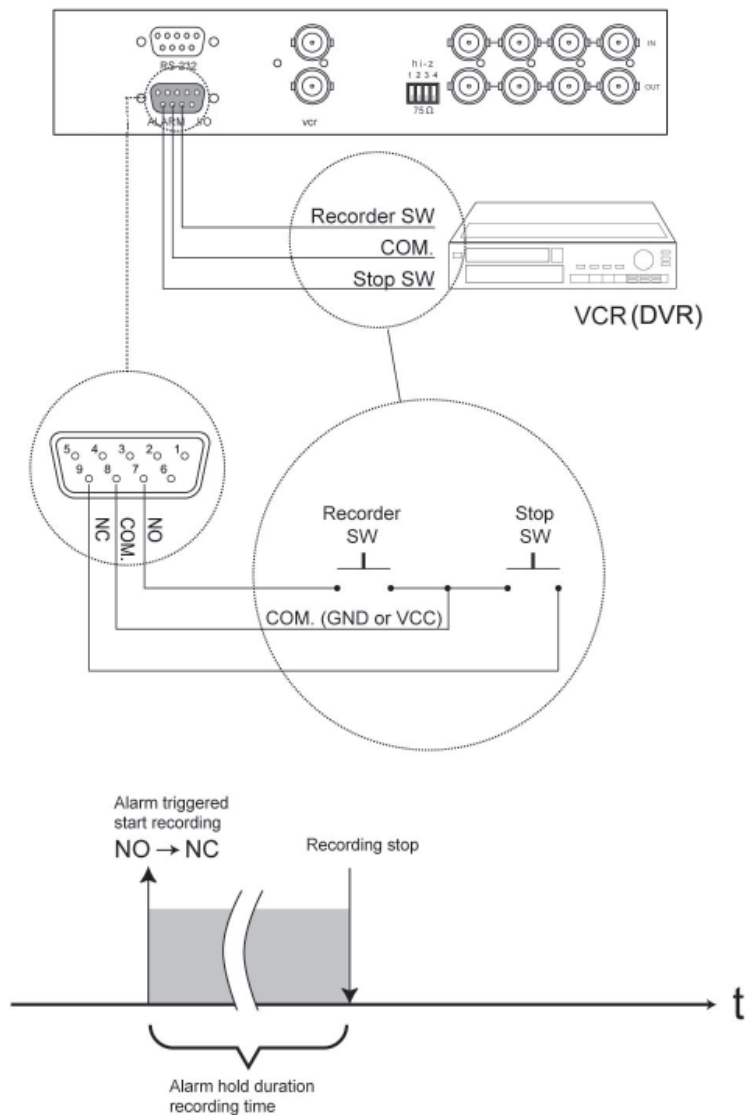

\*. If more than one sensor have been triggered, VCR will start to record after the last triggered event.

\*. In order to make use of the alarm called full screen display function, the VIDEO IN connector from the VCR has to be connected to LIVE monitor connector of the device. If more than one sensor are triggered, VCR will then record all the events in full screen mode accordingly.

**3 Sensor Activated Alarm**

The unit is equipped with 4 alarm sensor inputs. If any alarm is activated:

- the built-in buzzer and the alarm output control relay contact will be activated.
- the quad will switch the corresponding channel indicator LED to blinking mode.
- a warning message depending on different models will be displayed as follows:

Quad output channel (#4)	LIVE output channel (#5)				
<div style="text-align: center; border: 1px solid black; width: 100px; height: 100px; margin: 0 auto;"> <table border="1" style="width: 100%; height: 100%;"> <tr> <td style="text-align: center; vertical-align: middle;">Alarm</td> <td></td> </tr> <tr> <td></td> <td></td> </tr> </table> </div> <p>Blinking Alarm &amp; Title message on the activated channel in quad screen</p>	Alarm				<div style="text-align: center; border: 1px solid black; width: 150px; height: 100px; margin: 0 auto;"> <p style="text-align: center;">Alarm</p> </div> <p>Full screen display of the activated channel. Also display a blinking Alarm message</p>
Alarm					

Above mentioned alarm can be cleared by any of the following: 1. Connecting the Alarm Reset In contact, pin #5, of the female type 9 pin D-sub connector (#8) to GND. 2. The Alarm Duration time elapses. 3. If the device is operated under Security Lock ON mode, Push Lock button for 2 seconds to disable the function then push any button in the front panel.

**4 Video Loss Alarm**

Loss of video at any input is automatically detected by the device. The device will:

- Activate the built-in buzzer.
- Switch the corresponding channel indicator LED to blinking mode.
- Display warning message on quad screen:

Quad output channel (#4)				
<div style="text-align: center; border: 1px solid black; width: 100px; height: 100px; margin: 0 auto;"> <table border="1" style="width: 100%; height: 100%;"> <tr> <td style="text-align: center; vertical-align: middle;">Video loss</td> <td></td> </tr> <tr> <td></td> <td></td> </tr> </table> </div> <p>Blinking Video Loss &amp; Title message on the activated channel in quad screen</p>	Video loss			
Video loss				

- The warning message and the buzzer can be cleared by pushing Lock button (#2) for more than 4 seconds if the device is operated under Security lock On mode, or pushing any button on the front panel if the device is operated under Security lock OFF mode.

### < 4.3 > QD Remote Control Connection & Operation

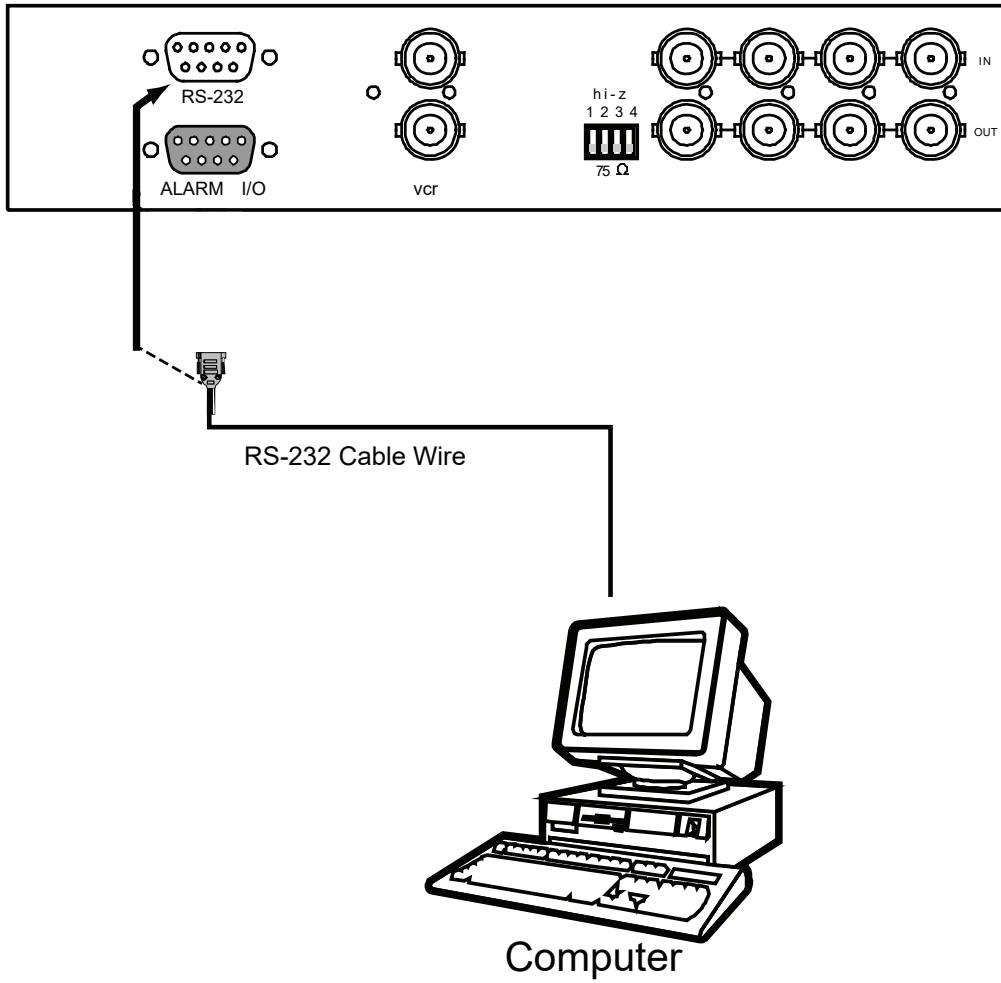



The device can be controlled via the male type 9 pin D-sub/RS-232 connector to a computer using ASCII code.

1. Pin assignment of the male type 9 pin D-sub connector:

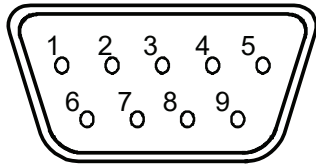

Pin Assignment for Remote Control Connector					
1	GND	4	NC	7	VCC
2	RX	5	NC	8	GND
3	TX	6	VCC	9	GND

When a computer is used to control this device through a RS-232 port, pin 6, 7, 8, and 9 must be disconnected to prevent connecting the VCC and GND signals from the device to the computer. A RS-232 port only uses pin 1, 2, and 3 for control signal transmission.

2. A terminal or computer can be connected to the male type 9 pin D-sub connector on the real panel from it RS-232 port to control this device using standard, uppercase ASCII codes.

2.1 The ASCII command codes for the quad are listed in the table below. The transmission protocol is 1200-baud rate, 8 data bit, 1 start bit, 1 stop bit, and no parity.

Function	ASCII Command Code
Quad Screen Display	E
CH 1	A
CH 2	B
CH 3	C
CH 4	D
Freeze *1	EA, EB, EC, ED
Auto Switching Sequence	F
VCR/Live	G
Key Lock *2	H
Setup Menu *3	GH
Text Select Down *4	(GH) A
Text Select Up	(GH) B
Cursor Left	(GH) C
Cursor Right	(GH) D
Alarm Reset	I

## < 4.3 > QD Remote Control Connection & Operation

\*1. In order to control the device to operate in Zoom mode, the computer has to first send command code " " to switch the signal source from camera to VCR/DVR, at this time the device will automatically zoom channel 1 video from VCR/DVR to full screen. User can then input a corresponding channel code to zoom any other specific channel. Input the corresponding channel code again to put the specific channel to freeze mode and send the code again to clear the freeze mode.

Example: Input GE, (GE) B, (GE) C, and (GE) D for zooming the video signal in channel 1 to 4 from VCR/DVR. Input "A", "B", "C", "D" again to freeze the specific channel. Send command code "G" again to get back to Live input mode.

\*2. Computer has to send out command code "H" continuously for 2 seconds to switch the device between security lock ON and OFF mode. If any alarm is activated under security lock ON mode, the device has to send out command code "H" continuously for more than 4 seconds to clear the alarm.

\*3. Setup menu is switched ON by sending VCR/DVR and Lock button codes together.

\*4. Text Select and Cursor Control functions can be performed only under menu Setup mode.

2.2 Right after computer/terminal has sent out the above mentioned control command code to the device, the device will respond with following status code back to computer through RS-232 port:

Status Code	Quad Status	Status Code	Quad Status
EF	Device in Quad mode	DE	CH1 in Sequence mode
EE	CH1 in Freeze mode	DD	CH2 in Sequence mode
ED	CH2 in Freeze mode	DB	CH3 in Sequence mode
EC	CH1 & 2 in Freeze mode	D7	CH4 in Sequence mode
EB	CH3 in Freeze mode	CF	Quad display in Sequence mode
EA	CH1 & 3 in Freeze mode		
E9	CH2 & 3 in Freeze mode	E	CH1 in Full screen mode
E8	CH1, 2, & 3 in Freeze mode	D	CH2 in Full screen mode
E7	CH4 in Freeze mode	B	CH3 in Full screen mode
E6	CH1 & 4 in Freeze mode	7	CH4 in Full screen mode
E5	CH2 & 4 in Freeze mode		
E4	CH1, 2 & 4 in Freeze mode		Attach to above code
E3	CH3 & 4 in Freeze mode	XX-DF	Buzzer/VCR ON
E2	CH1, 3, & 4 in Freeze mode	XX-7F	Security lock ON
E1	CH2, 3, & 4 in Freeze mode	XX-3F	Buzzer & Security lock ON (Stop)
E0	CH1, 2,3, & 4 in Freeze mode		

2.3 The configuration of the status code for both normal and alarm operations:

There are total 2 bytes of the status codes. Byte one, the first 8 bits, shows the current status of the operation modes that the unit is in. Byte two, the second 8 bits, shows the current status of the alarm operations of the unit.

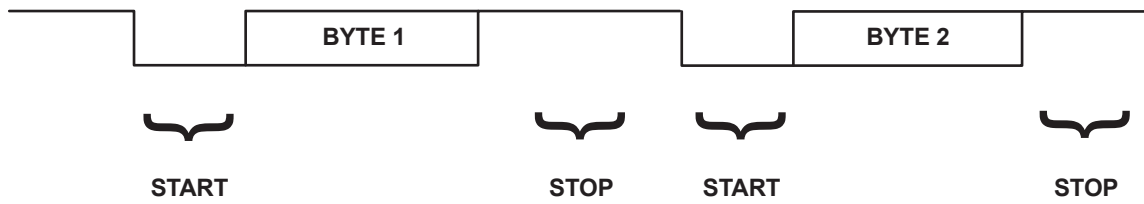

**BYTE 1:** Status code for normal operation modes

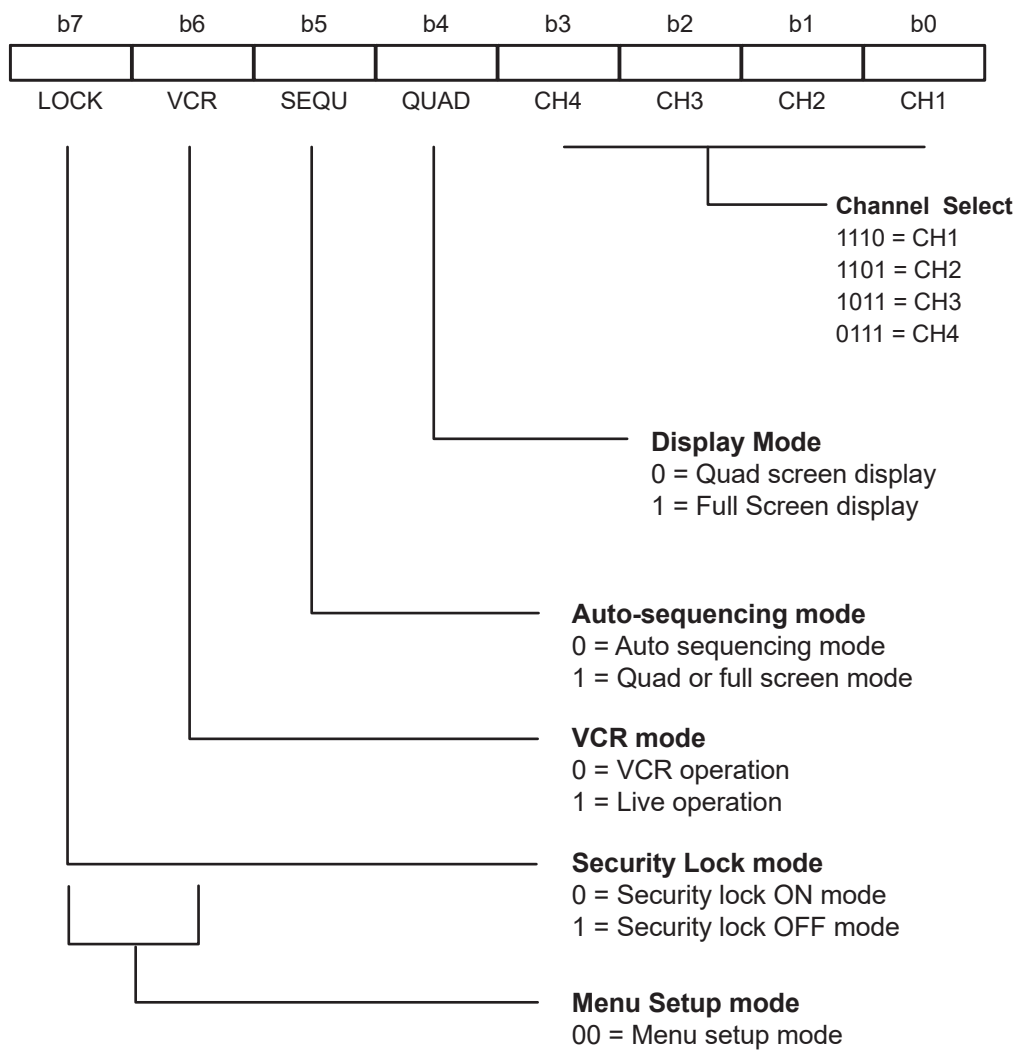

### < 4.3 > QD Remote Control Connection & Operation

BYTE 2: Status code for alarm operations: The first 4 bits show the sensor activated alarm status of each channel; next 4 bits show the video loss alarm status of each channel. The digit "1" means alarm event is detected, and "0" means no alarm event is detected.

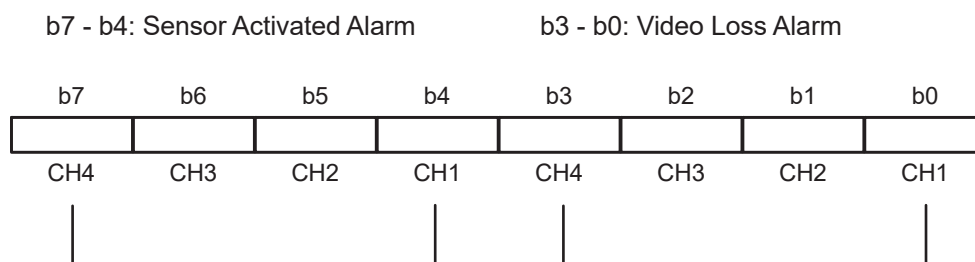

Sensor activated Alarm  
0001 = CH1 activated  
0010 = CH2 activated  
0100 = CH3 activated  
1000 = CH4 activated

Video Loss Alarm  
0001 = CH1 activated  
0010 = CH2 activated  
0100 = CH3 activated  
1000 = CH4 activated

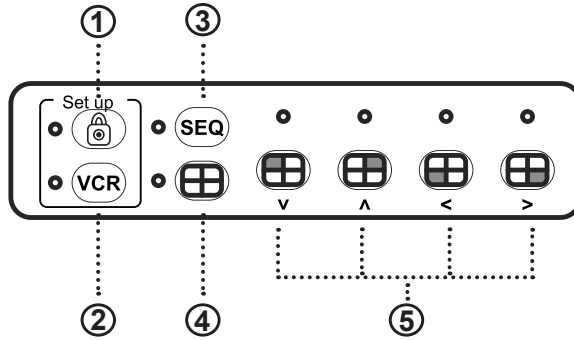

- ① Lock: Security locks out button. Push this button for 2 seconds to enable control panel lock out function. Push this button again for 2 seconds to disable the function.
- ② VCR: Push this button to enter into VCR Playback/Zoom operation. In this mode, the output video is displaying the video signal from VCR. When operated in Full Screen display mode, push select buttons (#5) to zoom any specific camera signal pre-recorded on the tape in quad format. Push the select button (#5) again to freeze the expanded picture on the screen.

VCR button (#2)	Quad button (#4)	CH Select button (#5)	Function
ON	ON	OFF	Display quad video signal from VCR tape
ON	OFF	Push Once	Call up specific quadrant from tape in full screen mode
ON	OFF	Push Twice	Freeze specific quadrant from tape in full screen mode
OFF	X	X	Exit VCR operation and back to normal operation mode

#1, #2 Setup buttons: Push these two buttons simultaneously to get into Menu Setup mode and display page 1 of system setup menu. Push these two buttons simultaneously again to display page 2 of the setup menu. Use page 1 to program time/date and camera title and page 2 to configure alarm operations. Under menu setup mode, Channel Select buttons (#5) are used for cursor control and text selection to program the setup menu. Push the setup buttons simultaneously again to save the setting. Push the setup buttons fourth time to get back to ordinary operation mode.

Setup buttons (#1, #2)	Function	CH Select buttons (#5)	
		UP, DOWN	< , >
Push once	Page 1 menu for time / date / title programming	Text Selection	Cursor Control
Push twice	Page 2 menu for alarm configuration	Text Selection	Cursor Control
Push the third time	Save the settings	Yes / No	
Push the fourth time	Exit setup mode, back to normal		

- ③ SEQ.: Push this button to enable full page auto sequencing mode. Push this button again to disable it.
- ④ : Push this button to switch between Quad/ Full Screen display mode.
- ⑤ buttons: When operated in Quad mode, these buttons are used to freeze any specific camera by pushing the corresponding button. When operated in Full Screen display mode, these buttons are used to select specific camera to be displayed in full screen.

Quad button (#4)	Channel Select buttons (#5)	Function
ON	ON	Freeze specific camera video in Quad screen mode
OFF	ON	Call up specific camera video in full screen mode

These buttons are also used as cursor control and text select keys under Setup menu mode.

## < 4.5 > QD On-screen Menu

Right after the unit is turned on, The monitor will display the last setting on the Setup Menu.

### 1. Page 1 of the Setup Menu - Display Setting

Push Setup buttons (#1, #2) simultaneously to display the Setup Menu on the screen. There are total two pages in the Setup Menu. Page 1 is used to program TIME, DATE, and camera TITLE. Page 2 is used to program Alarm Operations. Under this mode, channel selection buttons (#5) on the front panel are used for cursor control and text selection. Use the cursor control buttons "<" and ">" to move the cursor to the location as desired to program, and use the text select buttons " ^ " and " \ " to choose the right alphanumeric character to program.

Page 1: Setting the TIME, DATE, TITLE, and DWELL time:

CH	TITLE	DWELL	TIME
	QUAD		03S
1	CH 1		03 S
2	CH 2		03 S
3	CH 3		03 S
4	CH 4		03 S
LIVE VIDEO FREEZE			ON
VIDEO OUT:			QUAD
TITLE:			ON
TIME: 23 : 10 : 10			ON
DATE: 12 - 25 - 2003			ON

#### 1.1 TITLE setup:

The Title menu permits the setup of separate titles for each video channel. 8 characters may be entered for each video channel. The available alphanumeric characters are:

0, 1, 2, 3, 4, 5, 6, 7, 8, 9, A, B, C, D,..... X, Y, Z, . , : , - , / , < , > , ^ , \ , space ,

#### 1.2 DWELL Time setup:

The Dwell time menu permits setting the dwell time for all cameras and the Quad Screen on the LIVE output channel. The menu shows a table of all cameras and associated dwell time. Dwell time can be programmed by setting a number between 00 to 99 for each channel in the menu.

- 01 through 99: Adds the camera input to the auto switching SEQUENCE, with the corresponding dwell time in seconds.
- 00: Skips the camera input in the auto switching SEQUENCE.

#### 1.3 TIME/DATE setup:

Time and date information can be displayed on the video output channel through both LIVE and QUAD connector. Bottom of page 1 is used to set the values of time and date and also to enable or disable the display at each output channel.

The date and time will display in the "MM-DD-YYYY HH:MM:SS" format for NTSC model and "DD-MM-YYYY HH:MM:SS" format for PAL model.

#### 1.4 TITLE/TIME/DATE disable and enable on LIVE and QUAD video output channel:

The Title/Time/Date display on each output channel can be enabled or disabled by setting ON or OFF in the corresponding entry.

2 Page 2 of the setup menu- Alarm Setting

Push Setup buttons (#1, #2) simultaneously and push (#1) button again to display page 2 of the setup menu on the screen. This Alarm Setting menu is used to set the desired alarm configuration like sensor type, sensor sensitivity, alarm hold duration, and buzzer.

ALARM SETTING			
CH	SENSOR	TYPE	STATUS
1	OPEN	NO	ON
2	OPEN	NO	ON
3	OPEN	NO	ON
4	OPEN	NO	ON
SENSITIVITY:			0.3 S
DURATION:			30 S
BUZZER:			ON
V-LOSS ALARM:			ON
V-LOSS RELAY:			OFF

2.1 Sensor Type:

The machine will first detect the type of the sensor connected to the corresponding channel. The result will be displayed in the first column following each channel number. They can be on either OPEN or CLOSE. The menu then allows user to enter a desired type of the sensor for each channel in next column. NO means Normally Open. NC means Normally Close.

Then the menu will allow user to enable or disable sensor input for each channel in the next column. ON will enable the contact to detect the alarm status from the input. OFF will ignore the sensor input and disable the alarm detection from the input. Last column on this part of the menu shows the result of the actually detected sensor type and the desired configuration. If the setup type of the sensor is different from the actually connected type of sensor, a blinking “?” message will display. In this case, the buzzer will be activated when you exit the setup operation.

2.2 Alarm Sensitivity:

Alarm sensitivity can be programmed to different extent by setting the period of the triggered pulse detected by the sensor. The available settings are 100ms, 200ms, 300ms, 400ms, 500ms, 600ms, 700ms, and 800ms.

2.3 Alarm Hold Duration:

The alarm hold duration can be set from 00 second to 59 minutes. The duration can be set to non-stop by choosing “>>”. In this mode, the activated alarm can only be reset by connecting the alarm reset contact to ground.

2.4 Buzzer:

The device has a build-in buzzer to signal a detected alarm through sound. User can choose to disable the buzzer by setting it to OFF.

2.5 V-Loss Alarm:

This entry is used to enable or disable the video loss alarm. The device automatically detects loss of video at any input if this entry is set to ON. User can choose to disable this feature by setting it to OFF for applications like video conferencing or others that will need constant video source switching.

2.6 V-Loss Relay Control:

The device is equipped with an alarm controlled relay, which can be activated by both sensor triggered alarm and video loss alarm. This entry allows user to disable the relay activation from a loss of video in any camera input.

3 Save the settings and exit Setup Menu mode

Push (#1) button again will allow you to save the settings and go back to the normal operation mode and show a quad display on the screen.

## < 4.5 > QD On-screen Menu

4: The setup menu can be reset to factory setting by pushing the Setup buttons (#1, #2) and power on the quad simultaneously. The factory setting is as follows:

CH	TITLE	DWELL	TIME	ALARM SETTING			
	QUAD		03S	CH	SENSOR	TYPE	STATUS
1	CH 1		03 S	1	OPEN	NO	ON
2	CH 2		03 S	2	OPEN	NO	ON
3	CH 3		03 S	3	OPEN	NO	ON
4	CH 4		03 S	4	OPEN	NO	ON
	LIVE VIDEO FREEZE		ON		SENSITIVITY:		0.3 S
	VIDEO OUT:	LIVE	QUAD		DURATION:		30 S
	TITLE:	ON	ON		BUZZER:		ON
	TIME: 23 : 10 : 10	ON	ON		V-LOSS ALARM:		ON
	DATE: 12 - 25 - 2003	ON	ON		V-LOSS RELAY:		OFF

### 5. The Quad Display Mode

- 5.1 Push Quad display button (#4) to switch between Quad screen and Full screen display mode. Right after you turn on the system, the unit is in the quad mode and displays cameras 1-4.
- 5.2 Use page 1 of the Setup menu to turn the Title display ON/OFF on each channel and also enable and disable the Time and Date display on LIVE and QUAD output channels.
- 5.3 Under Quad screen mode, push channel select button to freeze each camera input.

### 6. The Full Screen Display Mode

- 6.1 Push Quad button (#4) to OFF to enter Full screen display mode. Under this mode, you may call up any specific channel in full screen by simply pushing the corresponding channel selection button.
- 6.2 Push the Quad button (#4) to ON to return to the quad mode.

### 7. The Still Frame Display Mode

- 7.1 If the still screen mode is desired, first turn the quad display button (#4) to ON to set the unit to display in the quad mode. At this time you may press any of the four channel selection buttons (#5) to freeze the corresponding channel.
- 7.2 Under Zoom On VCR playback mode, if the unit is showing quad screen, pushing the channel selection buttons (#5) will call up the specific channel to display in full screen. Push the same channel selection button again to freeze that channel in full screen.

### 8. The Auto-Sequence Mode

Push the Sequence button (#3) to ON to set the device to work as a sequencer. Under this mode, the display sequence first starts with a quad screen and then continues to display each camera input in full screen, and then gets back to quad screen and so on. Press the Sequence button (#3) to OFF to release this mode.



## < 4.6 > QD VCR Operation

RP-919QD

Zoom on VCR playback operation:

Push VCR button (#2) to ON will switch the device to VCR playback mode. Under this mode, if the device is on quad display mode, a pr-recorded quad display video in the tape will be shown on the screen. If the device is in Full screen display mode, push any channel select buttons (#5) will select and expand the corresponding quadrants of the pre-recorded video to full screen display.

## < 4.7 > Quad Display Specification

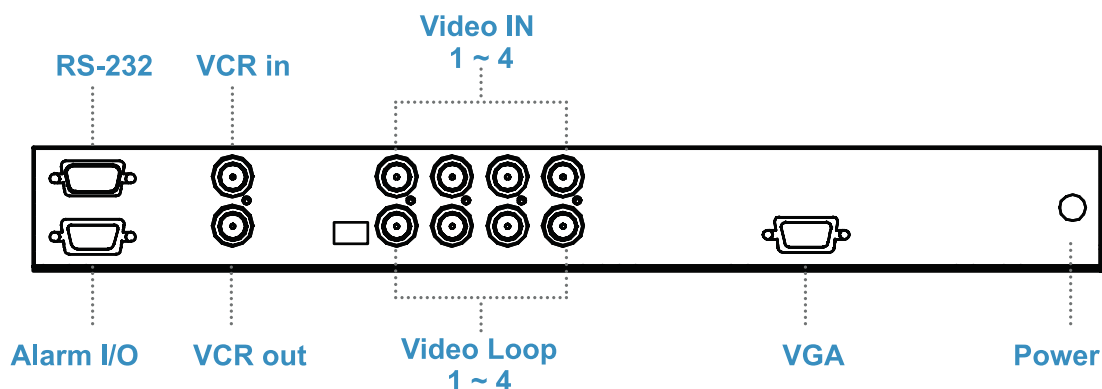

Item		Description
Model Number		QD (NTSC) : QD (PAL)
Number of Color		16.7 M : 16.7 M
Imaging System		NTSC : PAL
Resolution		1024 x 525 : 1024 x 625
Refresh Rate		60 : 50
Video Input	Camera Input	1.0 Vpp, 75 Ohm x 4
	VCR Input	1.0 Vpp, 75 Ohm x 1
Video Output	Live Monitor	1.0 Vpp, 75 Ohm x 1
	Loop Through Out	1.0 Vpp, 75 Ohm x 4
	VCR Output	1.0 Vpp, 75 Ohm x 1
Auto Gain Control		Yes
Time / Date		Yes
On Screen Display		Yes
Camera Title		8 Character Title
Display Format	2 x Zoom On Playback	Yes
	QUAD	Yes
	FULL	Yes
	SEQUENCY	Yes
Dwell Time		0 to 99 Sec Adjustable
Alarm Inputs		Selectable NO/NC Contacts x 4
Relay Outputs		NO/NC contacts x 1: 1A @DC24V Max.
Alarm Hold Time		1 Sec to Non-stop
Built-in Buzzer		Yes
Key Lock		Yes

# Intentionally Left Blank

# Intentionally Left Blank

The company reserves the right to modify product specifications without prior notice and assumes no responsibility for any error which may appear in this publication.

All brand names, logo and registered trademarks are properties of their respective owners.

Copyright 2022 Austin Hughes Electronics Ltd. All rights reserved.