

User Manual 55" 4K 3840 x 2160@60Hz LCD



AP-K55 / HAP-K55 
Aluminum front bezel

 **NAP-K55 / HNAP-K55**
Front NEMA4 / IP65



DP-K55 / HDP-K55 
Aluminum Front Panel



OP-K55 / HOP-K55 
Universal Open Frame

Legal Information

First English printing, July 2022

Information in this document has been carefully checked for accuracy; however, no guarantee is given to the correctness of the contents. The information in this document is subject to change without notice. We are not liable for any injury or loss that results from the use of this equipment.

Safety Instructions

Please read all of these instructions carefully before you use the device. Save this manual for future reference.

- Unplug equipment before cleaning. Don't use liquid or spray detergent; use a moist cloth.
- Keep equipment away from excessive humidity and heat. Preferably, keep it in an air-conditioned environment with temperatures not exceeding 40° Celsius (104° Fahrenheit).
- When installing, place the equipment on a sturdy, level surface to prevent it from accidentally falling and causing damage to other equipment or injury to persons nearby.
- When the equipment is in an open position, do not cover, block or in any way obstruct the gap between it and the power supply. Proper air convection is necessary to keep it from overheating.
- Arrange the equipment's power cord in such a way that others won't trip or fall over it.
- If you are using a power cord that didn't ship with the equipment, ensure that it is rated for the voltage and current labeled on the equipment's electrical ratings label. The voltage rating on the cord should be higher than the one listed on the equipment's ratings label.
- Observe all precautions and warnings attached to the equipment.
- If you don't intend on using the equipment for a long time, disconnect it from the power outlet to prevent being damaged by transient over-voltage.
- Keep all liquids away from the equipment to minimize the risk of accidental spillage. Liquid spilled on to the power supply or on other hardware may cause damage, fire or electrical shock.
- Only qualified service personnel should open the chassis. Opening it yourself could damage the equipment and invalidate its warranty.
- If any part of the equipment becomes damaged or stops functioning, have it checked by qualified service personnel.

What the warranty does not cover

- Any product, on which the serial number has been defaced, modified or removed.
- Damage, deterioration or malfunction resulting from:
 - Accident, misuse, neglect, fire, water, lightning, or other acts of nature, unauthorized product modification, or failure to follow instructions supplied with the product.
 - Repair or attempted repair by anyone not authorized by us.
 - Any damage of the product due to shipment.
 - Removal or installation of the product.
 - Causes external to the product, such as electric power fluctuation or failure.
 - Use of supplies or parts not meeting our specifications.
 - Normal wear and tear.
 - Any other causes which does not relate to a product defect.
- Removal, installation, and set-up service charges.

Regulatory Notices Federal Communications Commission (FCC)

This equipment has been tested and found to comply with the limits for a Class B digital device, pursuant to Part 15 of the FCC rules. These limits are designed to provide reasonable protection against harmful interference in a residential installation.

Any changes or modifications made to this equipment may void the user's authority to operate this equipment. This equipment generates, uses, and can radiate radio frequency energy and, if not installed and used in accordance with the instructions, may cause harmful interference to radio communications.

However, there is no guarantee that interference will not occur in a particular installation. If this equipment does cause harmful interference to radio or television reception, which can be determined by turning the equipment off and on, the user is encouraged to try to correct the interference by one or more of the following measures:

- Re-position or relocate the receiving antenna.
- Increase the separation between the equipment and receiver.
- Connect the equipment into an outlet on a circuit different from that to which the receiver is connected.

Contents

< Part. 1 > AP-K55 / NAP-K55 / HAP-K55 / HNAP-K55

1.1	Package Content	P.1
1.2	Structure Diagram & Dimension	P.2
1.3	Mounting Hardware & Installation	P.4

< Part. 2 > DP-K55 / HDP-K55

2.1	Package Content	P.5
2.2	Structure Diagram & Dimension	P.6
2.3	Mounting Hardware & Installation	P.8

< Part. 3 > OP-K55 / HOP-K55

3.1	Package Content	P.9
3.2	Structure Diagram & Dimension	P.10
3.3	Mounting Hardware & Installation	P.12

< Part. 4 > Specifications / OSD / Remote Controller

4.1	Product Specifications	P.13
4.2	On-screen Display Operation (OSD)	P.15
4.3	Picture In Picture (PIP) / Picture By Picture (PBP)	P.18
4.4	Remote Controller (RC-2)	P.20

< Part. 5 > Options

5.1	Option Table	P.21
5.2	12G / 4K60 / SD- SDI Broadcast-grade input	P.22
5.3	3G / HD / SD- SDI Broadcast-grade input	P.23
5.4	MCS Multi-display control solution	P.24
5.5	Touchscreen & driver	P.25
5.6	DC Power : 24V / 48V / 125V	P.26
5.7	MIL-type or lockable connector	P.27
5.8	Quad display for CCTV	P.28
5.9	Options for Sunlight Readable : Auto Dimming	P.29

< Part. 6 > Ultraview Family

6.1	K55	P.30
-----	-----	------

Before Installation

- It is very important to mount the equipment in a suitable cabinet or on a stable surface.
- Make sure the place has a good ventilation, is out of direct sunlight, away from sources of excessive dust, dirt, heat, water, moisture and vibration.

Unpacking

The equipment comes with the standard parts shown in package content. Check and make sure they are included and in good condition. If anything is missing, or damaged, contact the supplier immediately.

How To Clean Your LCD Monitor



Caution :

- To avoid the risk of electric shock, make sure your hands are dry before unplugging your monitor from or plugging your monitor into an electrical outlet.
- When you clean your monitor, do not press down on the LCD screen. Pressing down on the screen can scratch or damage your display. Pressure damage is not covered under warranty.
- Use only cleansers made specifically for cleaning monitors and monitor screens. Cleansers not made to clean monitors and monitor screens can scratch the LCD display or strip off the finish.
- Do not spray any kind of liquid directly onto the screen or case of your monitor. Spraying liquids directly onto the screen or case can cause damage which is not covered under warranty.
- Do not use paper towels or abrasive pads to clean your monitor. Using an abrasive pad or any wood based paper product such as paper towels can scratch your LCD screen.

Cleaning Your Monitor

To clean your LCD safely, please follow these steps :

- ① Disconnect the power cord.
- ② Gently wipe the surface using a clean, dry microfiber cloth. Use as little pressure as possible.

Cleaning Tough Marks and Smudges

To remove tough marks and smudges, please follow these steps :

- ① Disconnect the power cord.
- ② Spray a small amount of non-abrasive cleanser on a microfiber cloth.



Caution : Do not spray or apply any liquids directly onto the monitor. Always apply the solution to your microfiber cloth first, not directly on the parts you are cleaning.

- ③ Gently wipe the surface. Use as little pressure as possible.
- ④ Wait until your monitor is completely dry before plugging it in and powering it up.

**AP-K55 / NAP-K55
HAP-K55 / HNAP-K55**



- 55" 4K LCD display X 1
- 6ft DP cable X 1
- Power cord X 1
- Remote controller X 1

Basic I/O

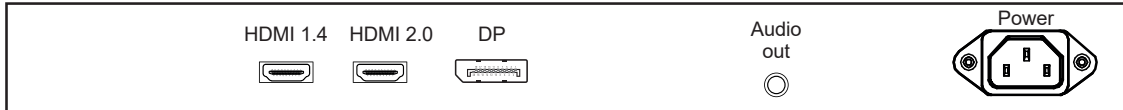

< 1.2 > Structure Diagram

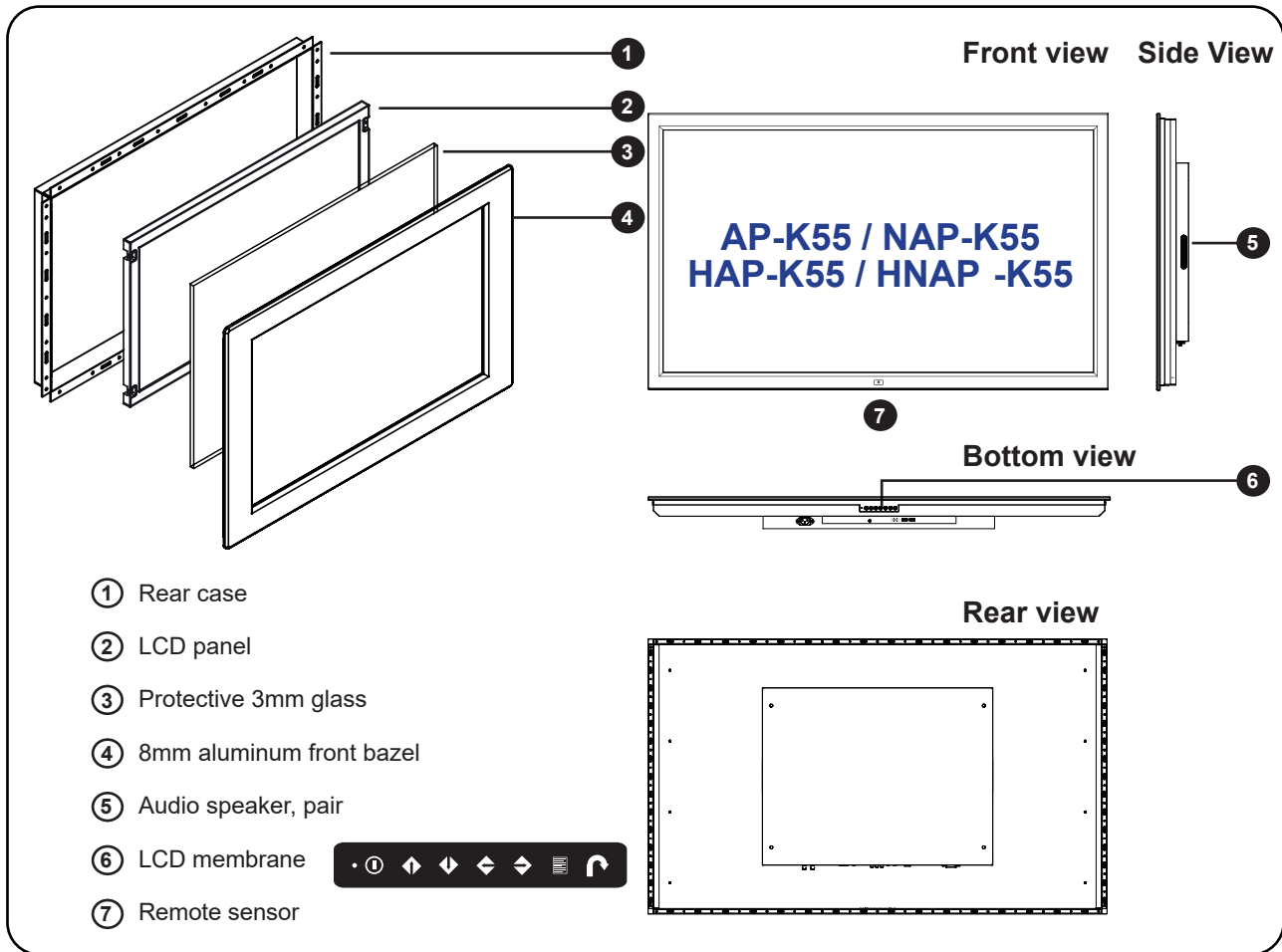

Model	Product Dimension (W x D x H)	Packing Dimension (W x D x H)	Net Weight	Gross Weight
AP-K55 HAP-K55	1295 x 89.3 x 776 mm 51 x 3.5 x 30.6 inch	1455 x 212 x 917 mm 57.3 x 8.3 x 36.1 inch	40 kg 88 lb	50 kg 110 lb
NAP-K55 HNAP-K55	1295 x 89.3 x 776 mm 51 x 3.5 x 30.6 inch	1455 x 212 x 917 mm 57.3 x 8.3 x 36.1 inch	48.6 kg 106.9 lb	58.6 kg 128.9 lb

Front View

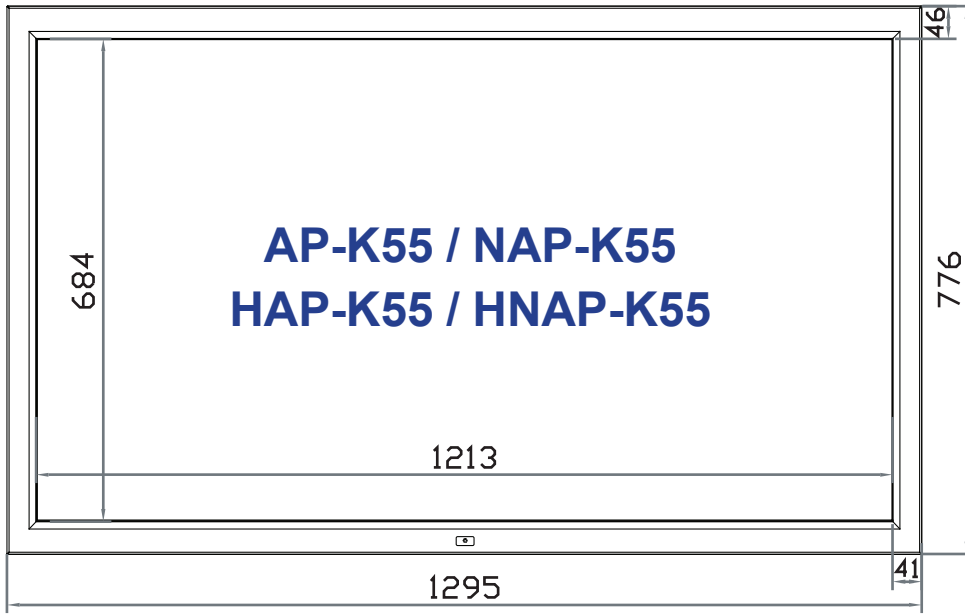

Side View

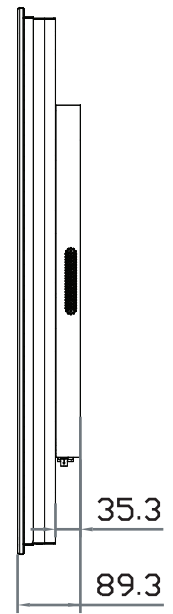

Rear View

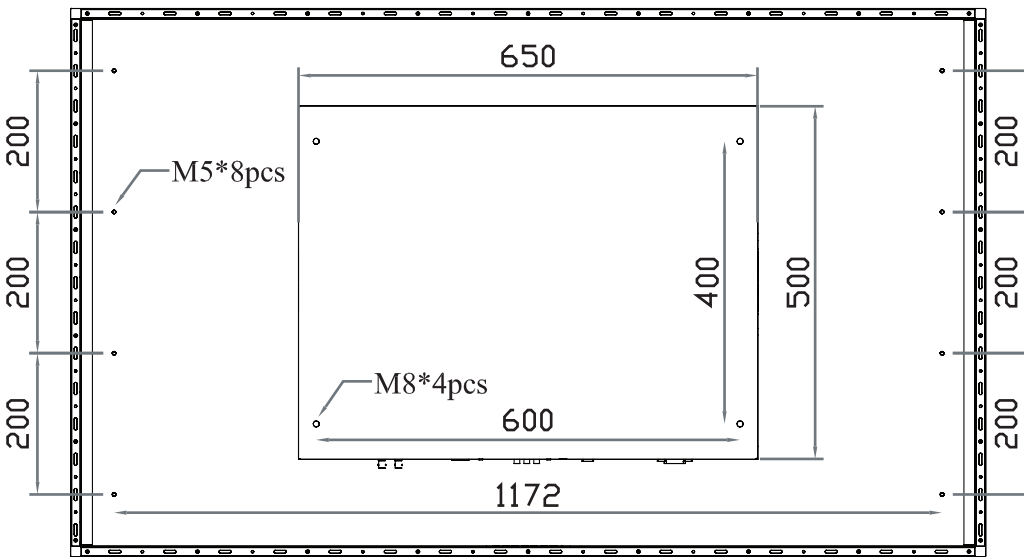

UNIT : mm
1mm = 0.03937 inch

Bottom View

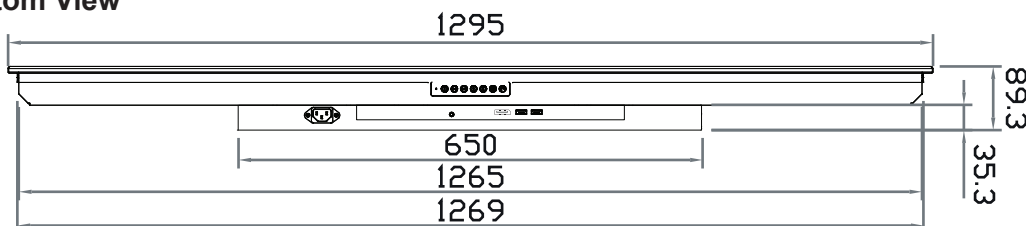

< 1.3 > VESA Installation

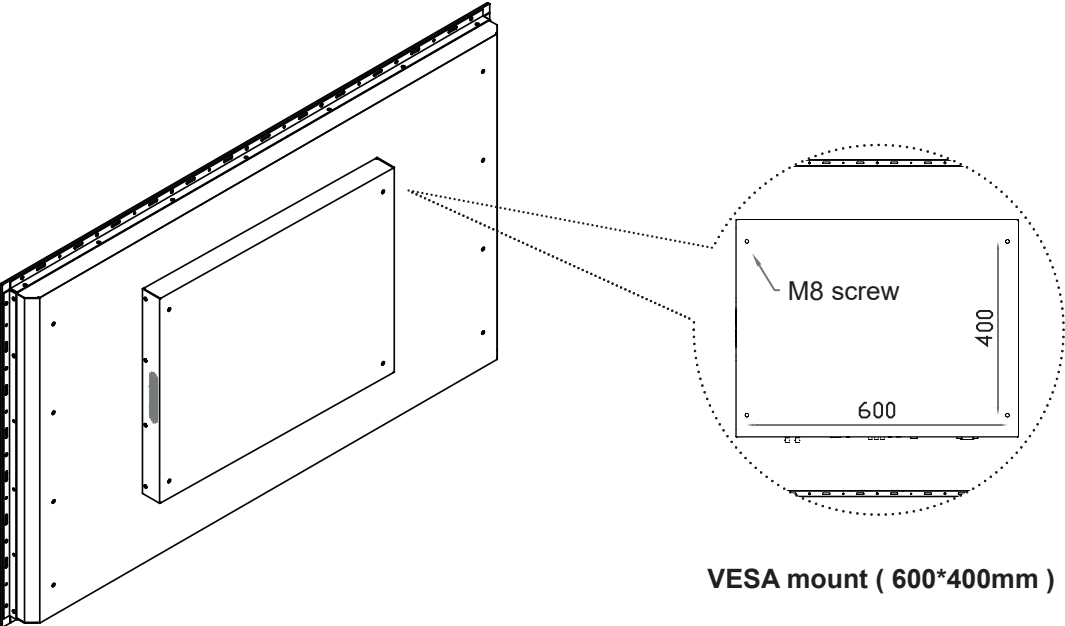

VESA mount (600*400mm)

- Hardware and M8*4 pcs for VESA mount are not provided

DP-K55 / HDP-K55



- 55" 4K LCD display X 1
- 6ft DP cable X 1
- Power cord X 1
- Remote controller X 1

Basic I/O

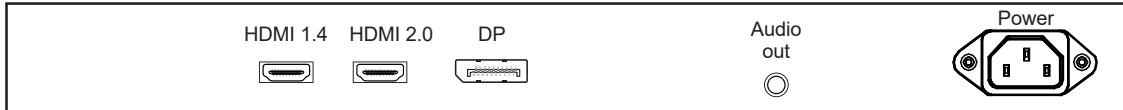

< 2.2 > Structure Diagram

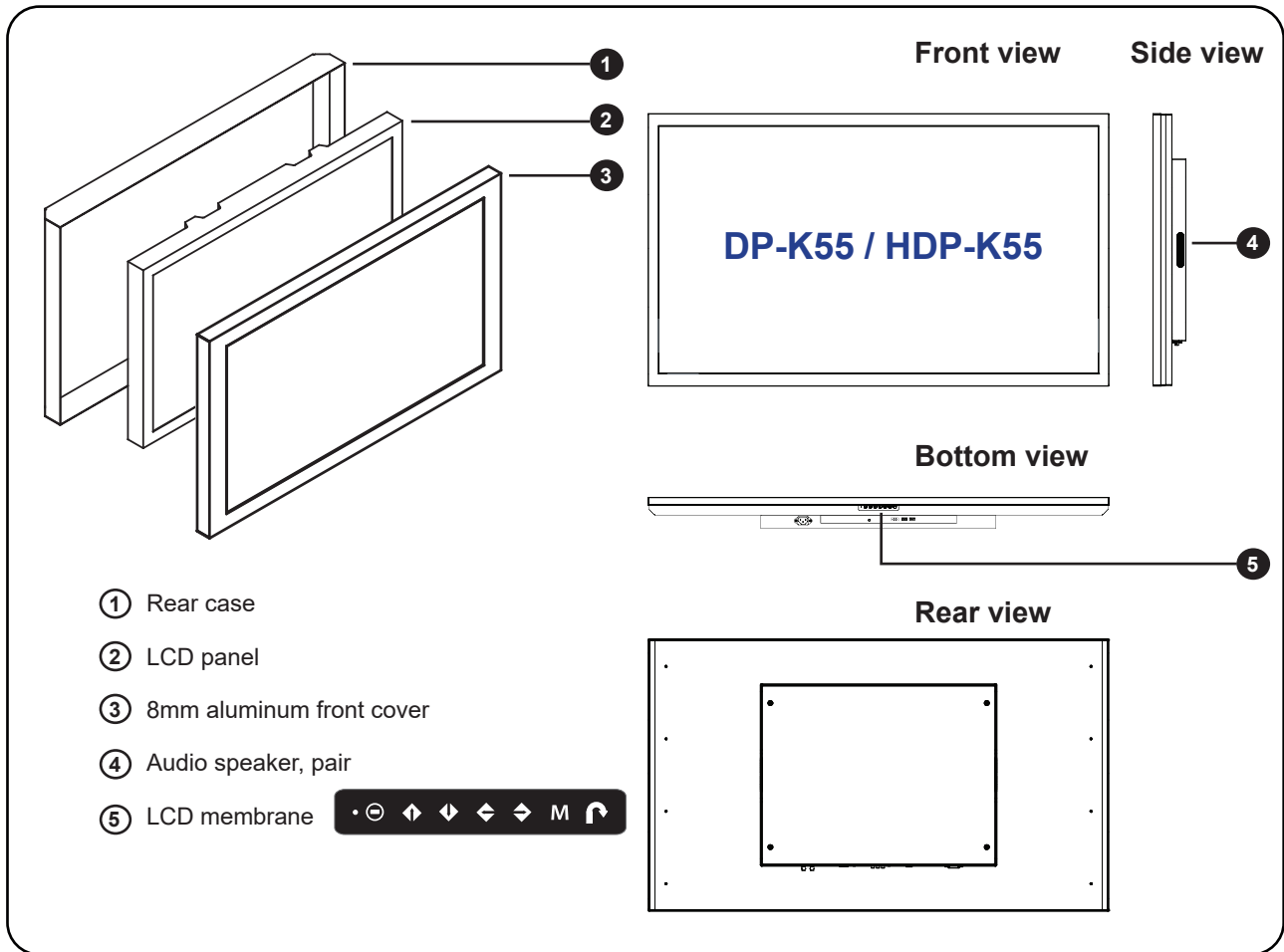

Model	Product Dimension (W x D x H)	Packing Dimension (W x D x H)	Net Weight	Gross Weight
DP-K55 HDP-K55	1269 x 83.1 x 750 mm 50 x 3.3 x 29.5 inch	1455 x 212 x 917 mm 57.3 x 8.3 x 36.1 inch	37 kg 81.4 lb	47 kg 103.4 lb

Front View

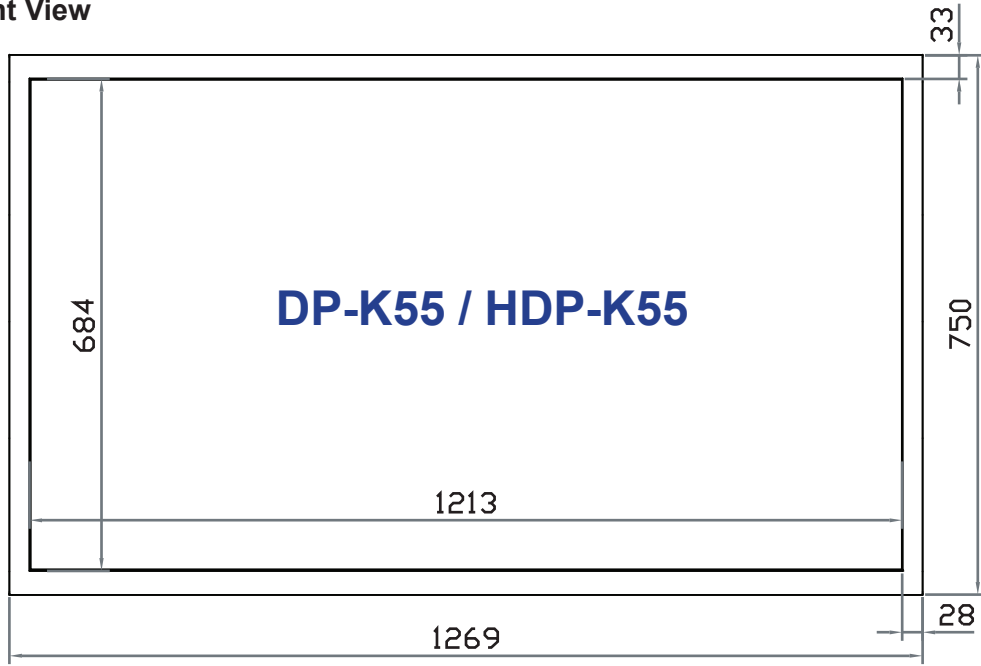

Side View

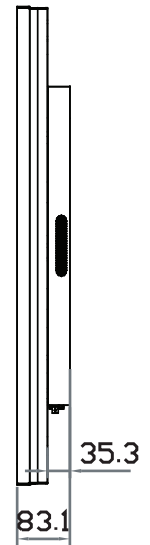

Rear View

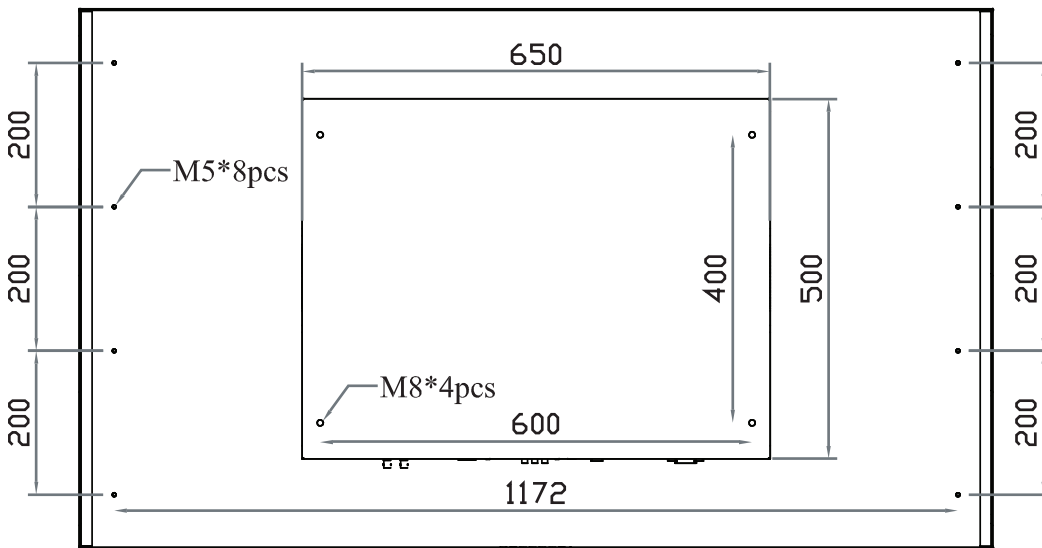

UNIT : mm
1mm = 0.03937 inch

Bottom View

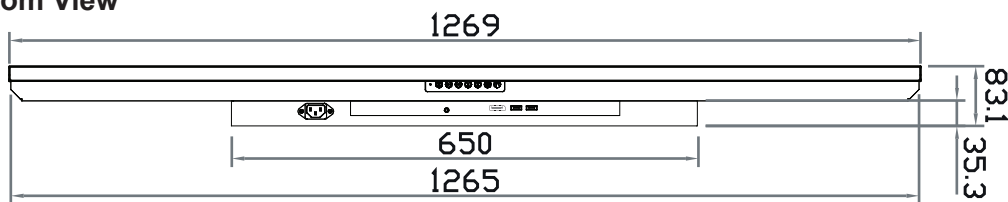

< 2.3 > VESA Installation

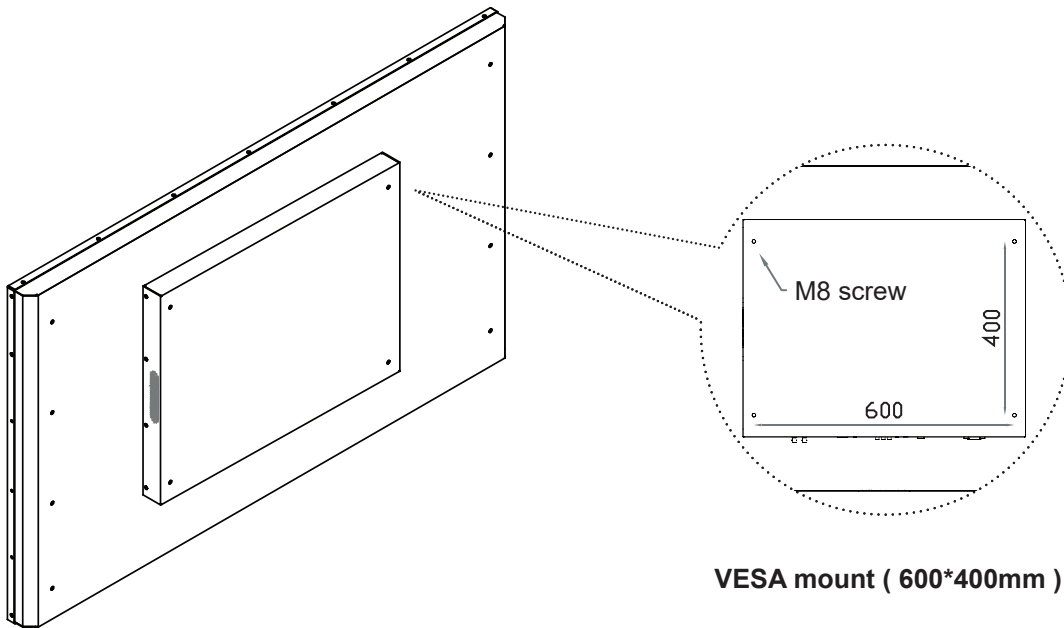

VESA mount (600*400mm)

- Hardware and M8*4 pcs for VESA mount are not provided

OP-K55 / HOP-K55



55" 4K LCD display X 1

6ft DP cable X 1

Power cord X 1

Remote controller X 1

Basic I/O

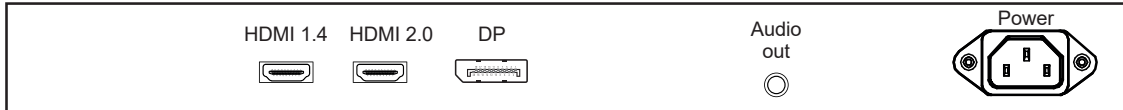

< 3.2 > Structure Diagram

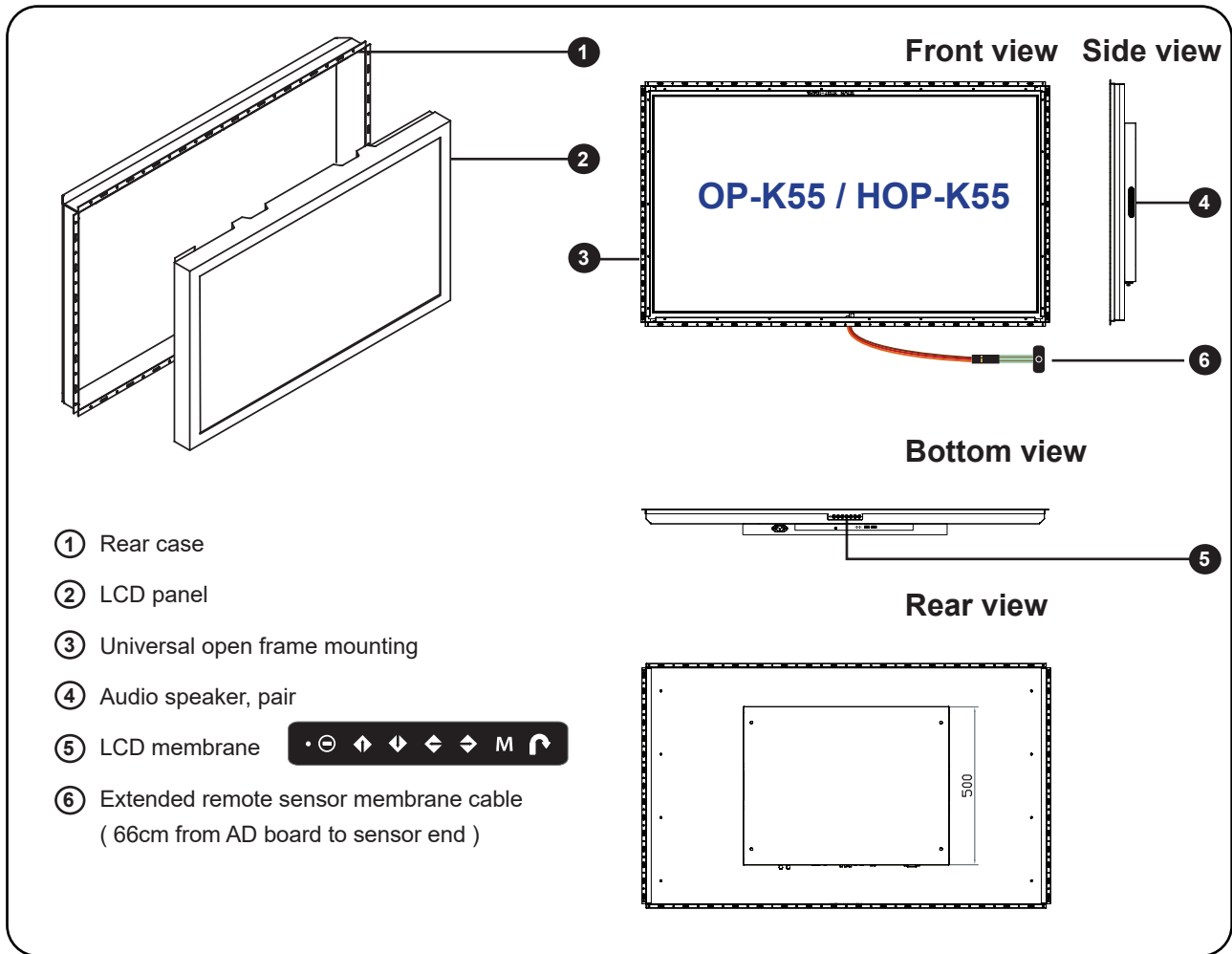

Model	Product Dimension (W x D x H)	Packing Dimension (W x D x H)	Net Weight	Gross Weight
OP-K55 HOP-K55	1292 x 81.3 x 773 mm 50.9 x 3.3 x 30.4 inch	1455 x 212 x 917 mm 57.3 x 8.3 x 36.1 inch	33 kg 72.6 lb	43 kg 94.6 lb

Front View

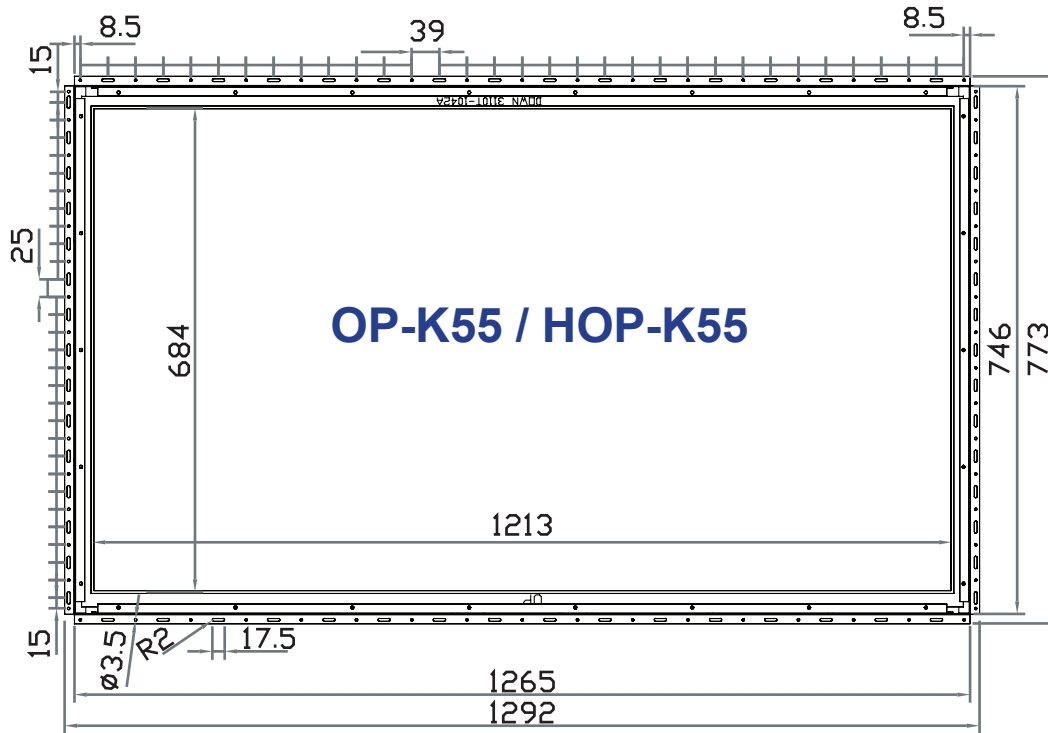

Side View

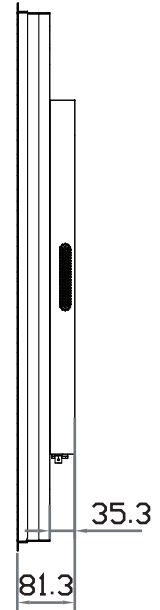

Rear View

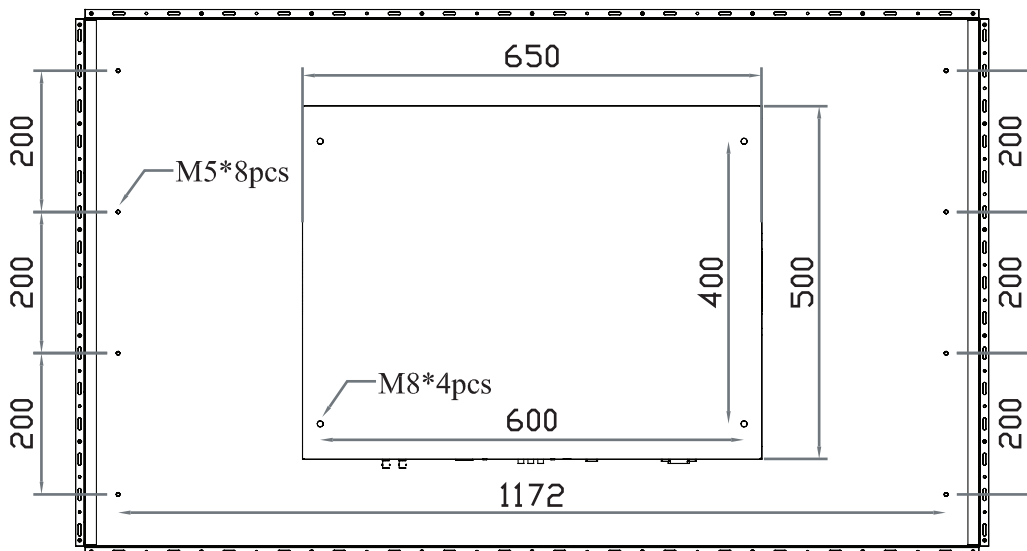

UNIT : mm
1mm = 0.03937 inch

Bottom View

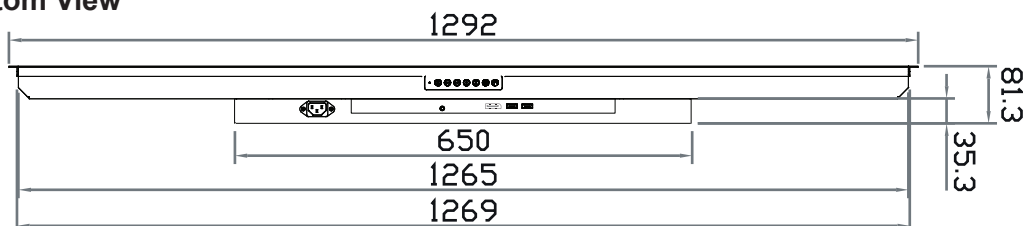

< 3.3 > Installation

(I) Universal mount

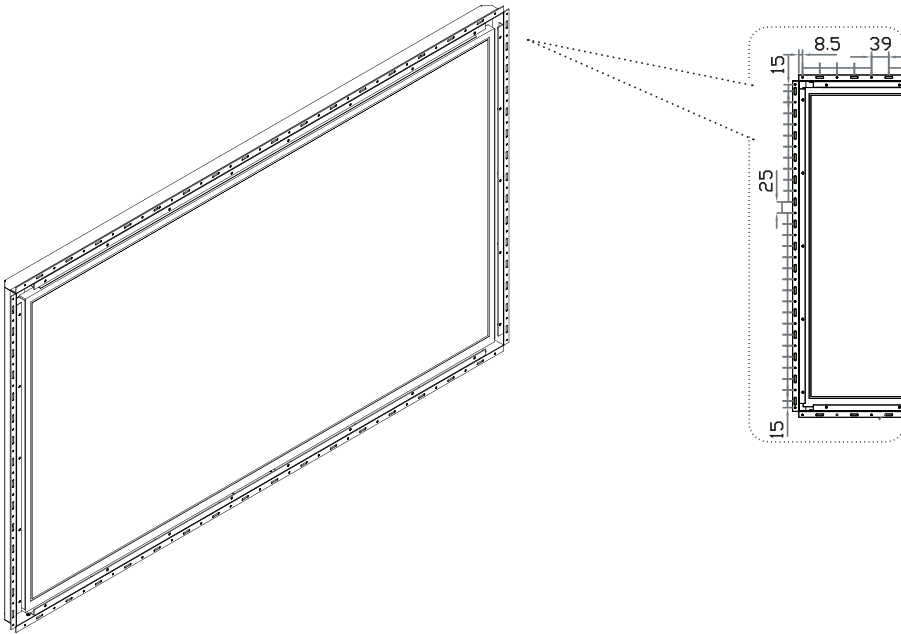

(II) VESA mount (600*400mm)

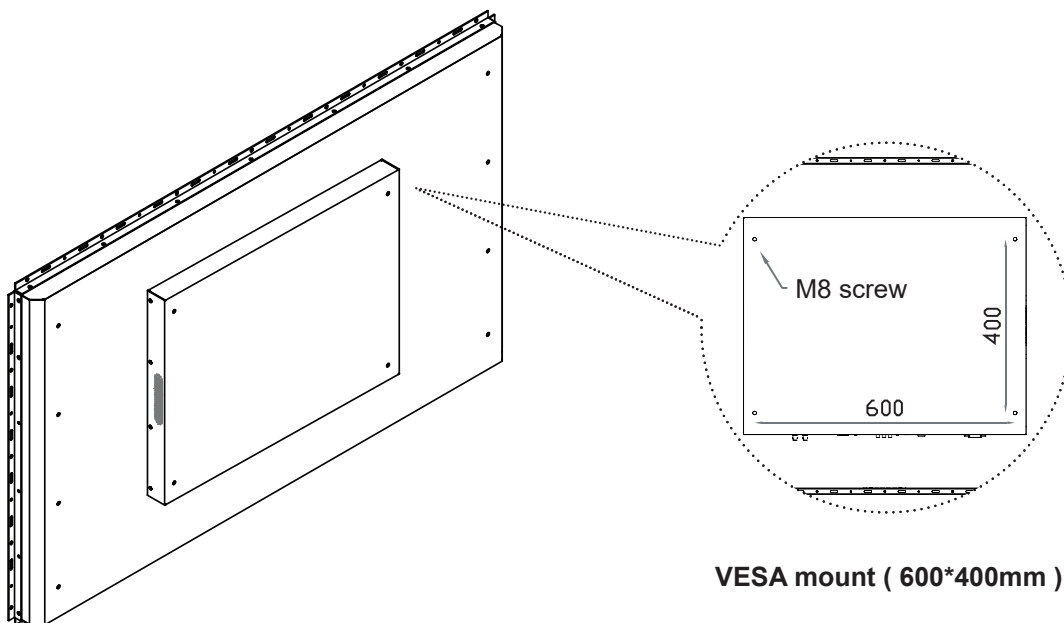

■ Hardware and M8*4 pcs for VESA mount are not provided

< Part 4 >

< 4.1 > Product Specifications

55" 4K LCD Display

Mechanical Design	AP-K55 / HAP-K55	NAP-K55 / HNAP-K55	DP-K55 / HDP-K55	OP-K55 / HOP-K55
Protection	8mm front bezel	NEMA 4 / IP65	front cover	open frame
Front Panel	Black, RAL 9005			-
Rear Casing	Black, RAL 9005			
VESA mount	600 x 400 mm			
Universal mount	-	-	-	ready
Overhead tilted wall-mount	option	-	option	-
Desktop stand	option	-	option	-

LCD Panel	Standard	Sunlight Readable
Brightness (cd/m ²)	450	700 
Contrast Ratio (typ.)	1200 : 1	4000 : 1
Panel Size (diagonal)	55-inch Widescreen TFT color LCD	
Native resolution	3840 x 2160@60Hz	
Colors	1.07 Billion, 10-bit	
Viewing Angle (L/R/U/D)	89/89/89/89	
Response Time (ms)	12	
Dot pitch (mm)	0.315	
Display Area (mm)	1209.60H x 680.40V	
Surface treatment	Anti-glare	
Surface hardness	2H	
Backlight Type	LED	
MTBF (hrs)	30,000	

Video	
Digital Display port	DP 1.2 / HDCP 1.3
HDMI	HDMI 2.0 / HDCP 2.2
	HDMI 1.4 / HDCP 1.4

Audio	
Output Connector	3.5mm stereo jack
Resistance / Power level	30kΩ / 2.8V
Speaker:	10W x 2
Dual Stereo	

*When the audio output is connected, speaker output is OFF

Power	Standard	Sunlight Readable
Input	Auto-sensing 100 to 240VAC, 50 / 60Hz	
Consumption:		
Screen ON	Max. 100W	Max. 335W
Power saving mode	Max. 9W	Max. 9W
Power button OFF	Max. 2W	Max. 2W

Compliance	
EMC	FCC & CE
Safety	CE / LVD & UKCA
Environment	RoHS3 & REACH / WEEE

< 4.1 > Product Specifications

Environmental Conditions		
Operating	Temperature	0 to 55°C degree
	Humidity	10~90%, non-condensing
	Altitude	16,000 ft
Storage / Non-operating	Temperature	-20 to 60°C degree
	Humidity	5~90%, non-condensing
	Altitude	40,000 ft
	Shock	10G acceleration (11ms duration)
	Vibration	10~300Hz 0.5G RMS random vibration





Physical Specification	AP-K55 / HAP-K55	NAP-K55 / HNAP-K55	DP-K55 / HDP-K55	OP-K55 / HOP-K55
Product (W x D x H)				
mm	1295 x 89.3 x 776		1269 x 83.1 x 750	1292 x 81.3 x 773
inch	51 x 3.5 x 30.6		50 x 3.3 x 29.5	50.9 x 3.3 x 30.4
Packing (W x D x H)				
mm	1455 x 212 x 917		1455 x 212 x 917	1455 x 212 x 917
inch	57.3 x 8.3 x 36.1		57.3 x 8.3 x 36.1	57.3 x 8.3 x 36.1
Net Weight	40 kg / 88 lb	48.6 kg / 106.9 lb	37 kg / 81.4 lb	33 kg / 72.6 lb
Gross Weight	50 kg / 110 lb	58.6 kg / 128.9 lb	47 kg / 103.4 lb	43 kg / 94.6 lb
Chassis color	Dark			
Chassis materials	Aluminum			

* All dimensions stated are subject to change if options are selected / integrated to base model part codes

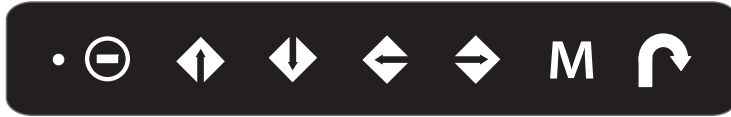
Applicable Format		
Display Port Input	PC Signal	3840 x 2160 x 60Hz
		2560 x 1440 x 60Hz
		1920 x 1080 x 60Hz
		1920 x 1200 x 60Hz
		1600 x 1200 x 60Hz
		1280 x 1024 x 60 / 75Hz
		1024 x 768 x 60 / 70 / 75Hz
		800 x 600 x 60 / 72 / 75Hz
		720 x 400 x 70Hz
		640 x 480 x 60 / 72 / 75Hz
	Audio Signal	2ch Linear PCM
HDMI Input	HDMI 2.0 / PC Signal	Same as Display port
	HDMI 1.4	3840 x 2160 x 30Hz
		2560 x 1440 x 60Hz
		1920 x 1080 x 50 / 60Hz (1080p)
		1920 x 1080 x 25 / 30Hz (1080i)
		1280 x 720 x 50 / 60Hz (720p)
720 x 480 x 50 / 60Hz (576p / 480p)		
	Audio Signal	2ch Linear PCM

- Power light
- Green = On
- Orange = Power saving



Membrane Switch	Function
	Power on / off LCD
	Display the OSD menu
	Scrolls through menu options and adjusts the displayed control (To auto adjustment by pressing the button  for 5 seconds)
	Exit the OSD screen Toggle analog, digital & video connection (DVI-D and video options only)

< 4.2 > On-screen Display Operation (OSD)

① Picture

Brightness : Adjust the screen brightness

Contrast : Adjust the difference between the image background (black level) and the foreground (white level)

Black level : Adjust background black level of the screen

Eco : Screen in power saving mode

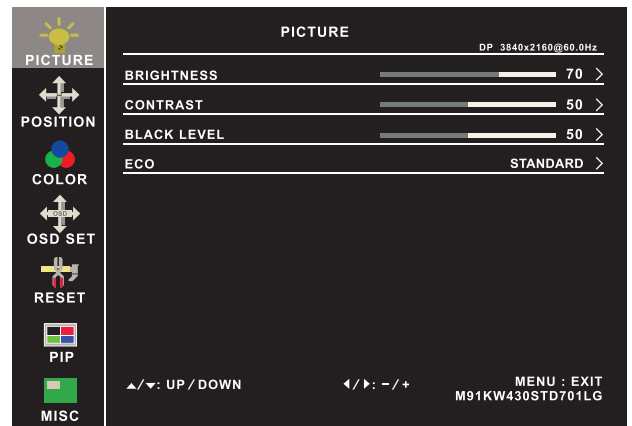

② Position

Picture size : Adjust the image size
- Full Screen / 4:3 / 5:4 / Pixel to Pixel

DP version : Select the DP version

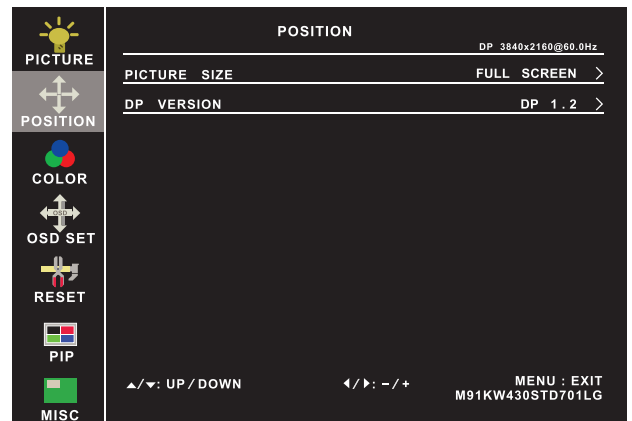

③ Color

Color temperature : User / Warm / Cool / 5400k mode and Red / Green / Blue color balance

Sharpness : Adjust the image from weak to sharp

Hue : Adjust the screen hue value

Saturation : Adjust the saturation of the image color

Dynamic

luminous control : Control the dynamic brightness

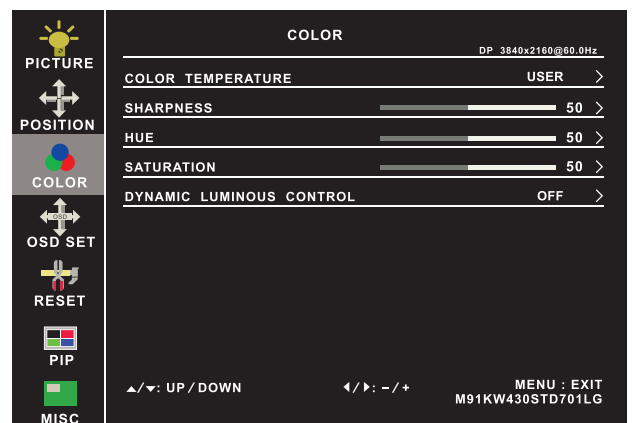

④ OSD Set

Language : Select the language in which the OSD menu is displayed - English

OSD H-Position : Align the screen image left or right

OSD V-Position : Align the screen image up or down

OSD time out : Adjust the screen timeout

OSD transparency : Adjust the screen transparency

OSD size : Adjust the screen size - Normal / Small

OSD rotation : Rotate the screen - 90° / 180° / 270°

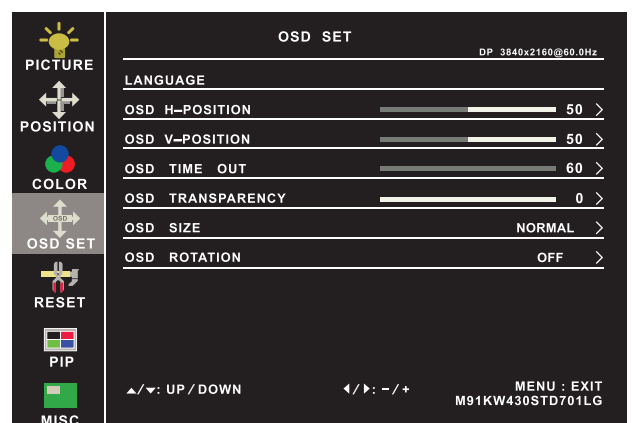

< 4.2 > On-screen Display Operation (OSD)

55" 4K LCD Display

⑤ Reset

Reset : Return the adjustment back to factory setting

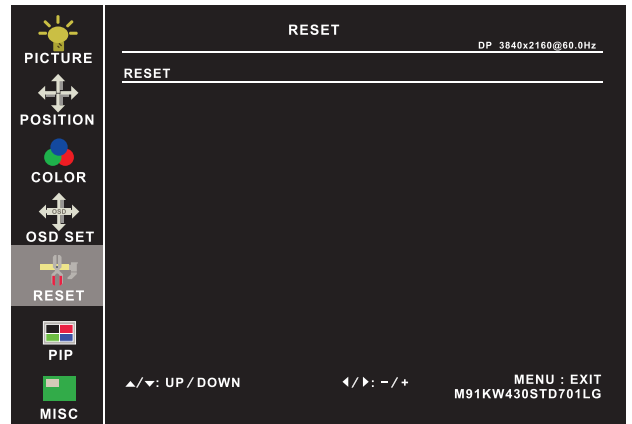

⑥ PIP

PIP mode : Enter into PIP / PBP setting - PIP MODE / PBP 2WIN (Main screen + 1 sub screen) / PBP 3WIN (Main screen + 2 sub screen) / PBP 4WIN (Main screen + 3 sub screen)
Select the signal input of each sub screen

PIP size : Adjust the size of the Sub screen
- Small / Medium / Large / Huge

PIP position : Adjust the position of the Sub screen
- Top Left / Top Right / Bottom Left / Bottom Right

Swap : Swap the input signal of PIP / PBP sub screen

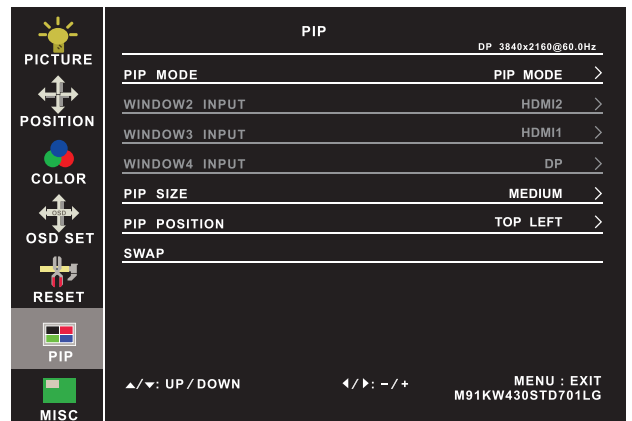

⑦ MISC

Signal source : Select the signal source - DP / HDMI1 / HDMI2

Mute : Turn off the surrounding sound

Audio in : Auto / Line in / DP

Volume : Adjust the volume of sound

Sleep mode : Set the off time - 10 min / 20 min / 30 min / 50 min / 60 min / 120 min / 240 min

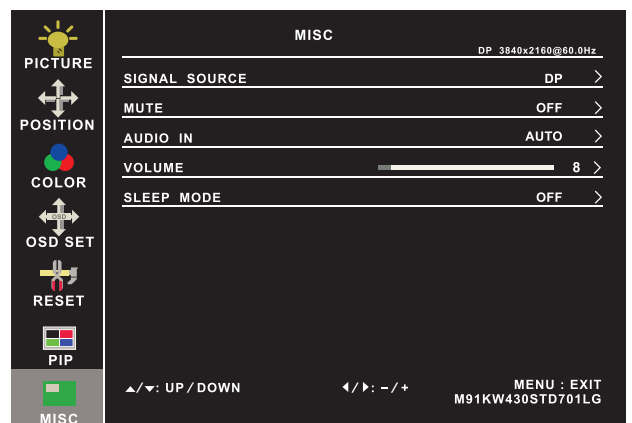

Options on Reset page

Rotation : Rotate the image in Full screen or 1:1
- 90° / 180° / 270°

Picture size : Adjust the image size in Full screen or 1:1

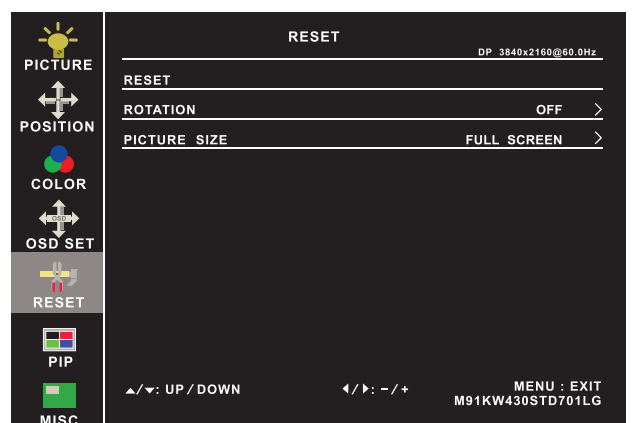

< 4.3 > How to Use Picture In Picture (PIP) / Picture By Picture (PBP)

< 4.3.1 > Picture in Picture (PIP)

Mode

Display the Sub screen in the Main screen.

OSD Menu → MISC → PIP Mode → Large / Small / OFF

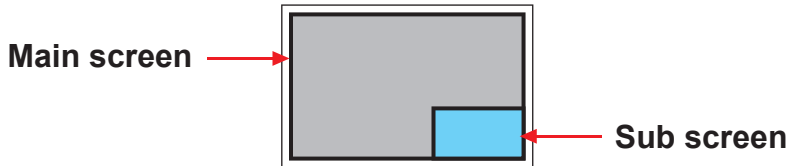

Position

Adjust the position of the Sub screen (top left, bottom left, top right, bottom right)

OSD Menu → MISC → PIP Position → top left / top right / bottom left / bottom right

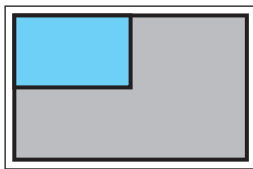

top left

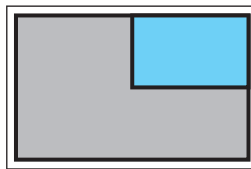

top right

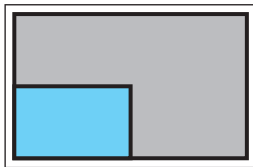

bottom left

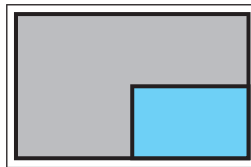

bottom right

Size

Adjust the size of the Sub screen (Large / Small)

OSD Menu → MISC → PIP Mode → Large / Small

Size of Sub screen

LCD Monitor	Large Sub screen	Small Sub screen
1920 x 1200	552 x 414	480 x 360
1920 x 1080	552 x 414	480 x 360
1440 x 900	414 x 310	360 x 270
1366 x 768	392 x 294	340 x 254
1280 x 1024	368 x 276	320 x 240

< 4.3.2 > Picture By Picture (PBP)

Mode

Display the Sub screen next to the Main screen.
 OSD Menu → MISC → PIP Mode → PBP



Size

LCD Monitor	Main / Sub screen
1920 x 1200	955 x 716
1920 x 1080	955 x 716
1440 x 900	715 x 536
1366 x 768	678 x 508
1280 x 1024	635 x 476

< 4.3.3 > PIP / PBP Source

To select an input signal for PIP / PBP Sub screen.
 OSD Menu → MISC → PIP Source → HDMI / SDI

The PIP / PBP is operable in the following table :

Main \ Sub	HDMI	SDI
HDMI	X	O
SDI	O	X

< 4.4 > Remote Controller (RC-2)

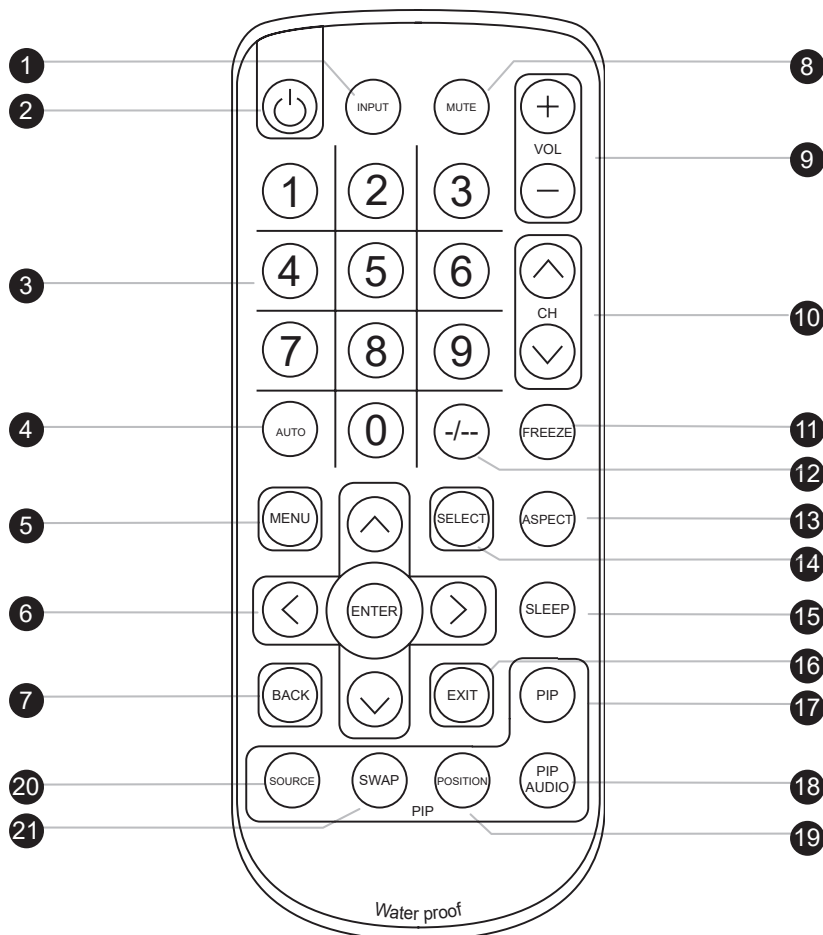

①	INPUT	Select the source
②	⏻	Switches on or off the TV
③	0 - 9	Only use in TV mode. Select channels. For channel numbers 10 and above, enter the second digit within two seconds.
④	AUTO	Auto adjust
⑤	MENU	Display the menu on the screen or go to the previous menu
⑥	▲ / ▼ / ◀ / ▶ / ENTER	Go to the upper menu or select the previous value / Go to the next menu or select the next value / Decrease the setting value / Increase the setting value or enter to the select item setting Enter to the select item settings or excude the setting
⑦	BACK	Back to previous value
⑧	MUTE	Turn on or off the speaker
⑨	Vol + / -	Increase or decrease the speaker volume
⑩	CH + / -	For TV model only, increase or decrease the channel number
⑪	FREEZE	Reserve for OEM model
⑫	- / --	For setting input single or double digits
⑬	ASPECT	Adjust the screen size
⑭	SELECT	To select the existing item
⑮	SLEEP	Select the sleeping time
⑯	EXIT	Exit the menu or cancel
PIP functions		
⑰	PIP	Picture in picture
⑱	PIP AUDIO	To set the audio of in PIP mode
⑲	POSITION	To set the screen position in PIP mode
⑳	SOURCE	PIP Source
㉑	SWAP	Swap screen in PIP mode

< Part 5 > Options
 < 5.1 > Option Table

55" 4K LCD Display

Options	AP / NAP	HAP / HNAP	DP	HDP	OP	HOP
SDI	✓	✓	✓	✓	✓	✓
MCS multi-screen control	✓	✓	✓	✓	✓	✓
Touchscreen	✓	✓	✓	✓	✓	✓
DC Power	✓	✓	✓	✓	✓	✓
MIL-type / lockable connector	✓	✓	✓	✓	✓	✓
Quad display	✓	✓	✓	✓	✓	✓
Auto / switch dimming		✓		✓		✓

< 5.2 > Options : 12G / 4K60 / SD-SDI

Austin Hughes' SDI input is an ideal solution for the broadcast-grade video and high resolution CCTV market.

Designed for use with displays, a SDI input module can support up to 3840 x 2160p @60Hz resolution without using additional space or power and it comes standard with a 2-year warranty.

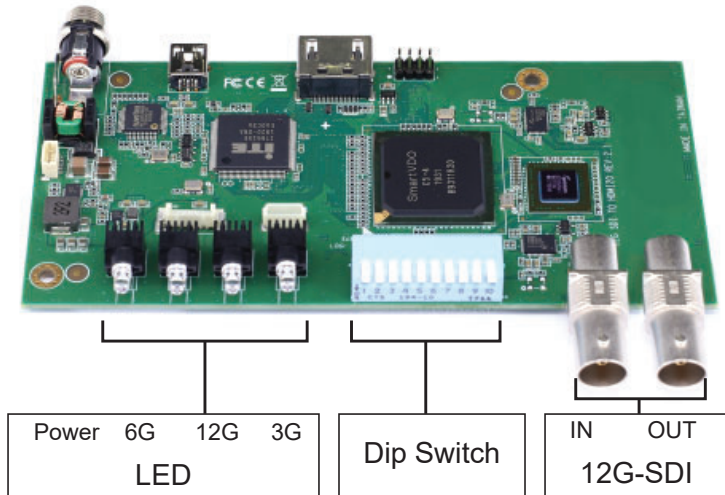

Product Specifications

INPUT

12G-SDI IN	BNC RG6 / RG59 (75Ω)
------------	------------------------

OUTPUT

12G-SDI OUT	BNC RG6 / RG59 (75Ω)
-------------	------------------------

Compatible Video Format

12G-SDI IN	3840 x 2160p	@60 / 50fps
6G-SDI IN	3840 x 2160p	@30 / 25 / 24fps
3G-SDI IN	1920 x 1080p	@60 / 50fps
HD-SDI IN	1920 x 1080p	@30 / 25 / 24fps
	1920 x 1080i	@60 / 50fps
	1280 x 720p	@60 / 50fps

Dip Switch Mode

Output Color

	4	5
YUV444	OFF	OFF
YUV422	OFF	ON
RGB444	ON	OFF
YUV420	ON	ON

EQ

	6	7
Auto	OFF	OFF
Disable	OFF	ON
Enable	ON	OFF

Out1 Cable length

	8
Short	OFF
Long	ON

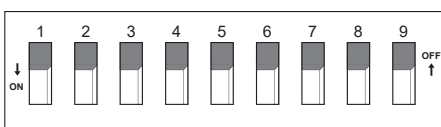

< 5.3 > Options : 3G / HD / SD-SDI input

55" 4K LCD Display

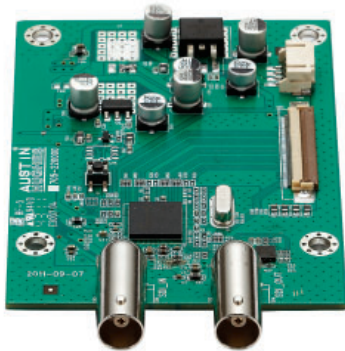

Austin Hughes' SDI input is an ideal solution for the broadcast-grade video and high resolution CCTV market.

Designed for use with UltraView displays, a SDI input module can support up to 1080p @60Hz resolution without using additional space or power and it comes standard with a 2-year warranty.

SDI

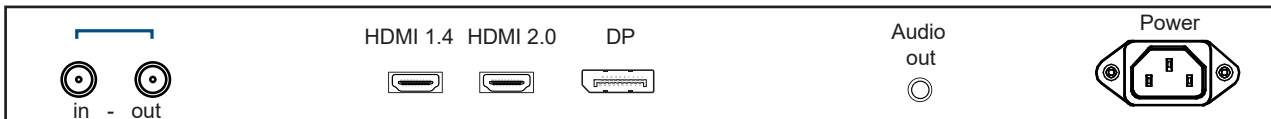

INPUT	3G-SDI IN	BNC x 1 / 0.8Vp-p (75 ohm)
	3G-SDI OUT	BNC x 1 / Active through, equalized & relocked

Standard Compliance	Video	SMPTE 425M / 274M / 296M / 125M ITU-R BT.656
	Audio	SMPTE 299M / 272M-C

Compatible Video Format	3G-SDI	1080p @60 / 50Hz, 4:2:2
		1080p @30 / 25 / 24Hz, 4:4:4
		1080i @60 / 50Hz, 4:4:4
		720p @60 / 50Hz, 4:4:4
	HD-SDI	1080p @30 / 25 / 24Hz, 4:2:2
		1080i @60 / 50Hz, 4:2:2
		720p @60 / 50Hz, 4:2:2
	SD-SDI	480i @60Hz, 4:2:2
	ITU-R BT.656	576i @50Hz, 4:2:2

Compatible Audio Format	3G-SDI	48kHz, 16 / 20 / 24 bit, 2 CH, Synchronized Video
	HD-SDI	48kHz, 16 / 20 / 24 bit, 2 CH, Synchronized Video
	SD-SDI	48kHz, 16 / 20 / 24 bit, 2 CH, Synchronized / Asynchronous Video

Max. Transmission Distance 75 ohm coaxial cable	3G-SDI	150m at 2.97Gb/s
	HD-SDI	250m at 1.485Gb/s
	SD-SDI	480m at 270Mb/s

< 5.4 > Options : MCS

MCS (Multi-display Control)

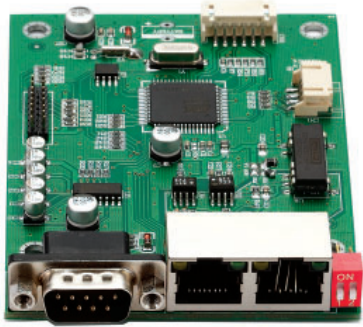

More control is always good. Especially when it is necessary and easy. Austin Hughes provides MCS solution to control the **OSD** of various UltraView LCD display up to 64 units.

The RS-232C is used for the communication between the PC and the first display via a 15 feet serial cable while the CAN bus is used for the various LCD displays cascade together via CAT 5/6 cable, and daisy chain up to 1,000 meters.

Designed for use with UltraView LCD displays, Austin Hughes provides a MCS input module without using additional space or power and it comes standard with a 2-year warranty.

MCS

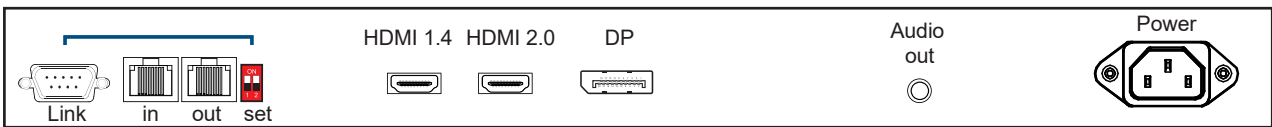

*** Please download the protocol of MCS control at :
<http://www.austin-hughes.com/support/usermanual/ultraview/UM-UV-MCS.pdf>

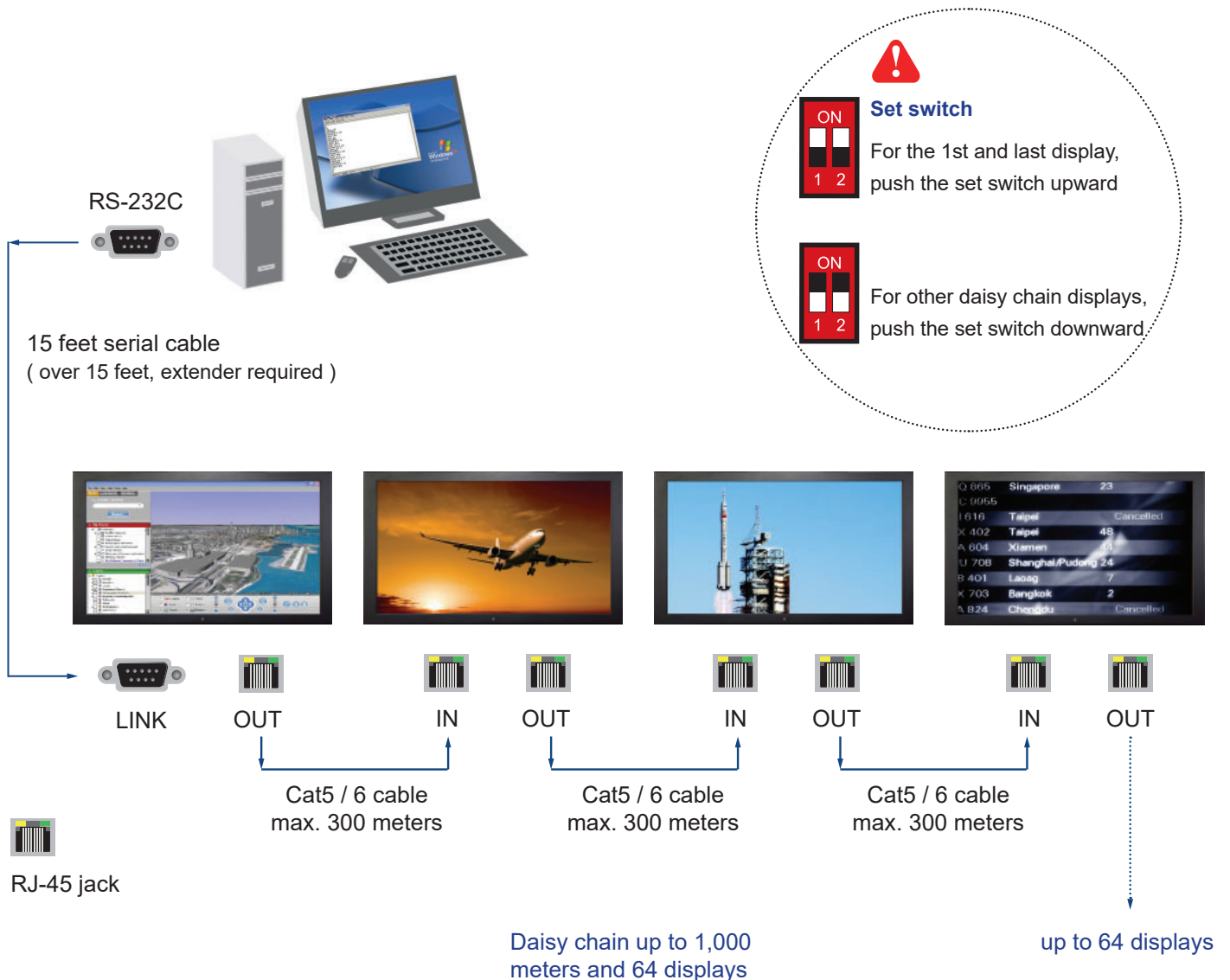



K55" USB Touchscreen Specification

Model	IR10 Multi-touch
Technology	Infrared
Touch Point	10
Input Type	Pen, Finger, Finger of gloved hand activation
Touch Point Accuracy	± 2 mm
Response Speed	≤ 15 ms
Activation Force	No minimum touch activation force
Touch Durability	Unlimited
Glass Thickness	3 mm
Connector	A-type USB
Operating System	Windows 7 / Windows 10

- Dimension will be changed if touchscreen required
- USB touchscreen package includes 1 x 6ft USB cable, quick reference guideline and CD disc
- For detailed information, please refer to the attached CD disc
- As the touchscreen unit is not made of toughened glass, please handle it carefully

USB Touchscreen

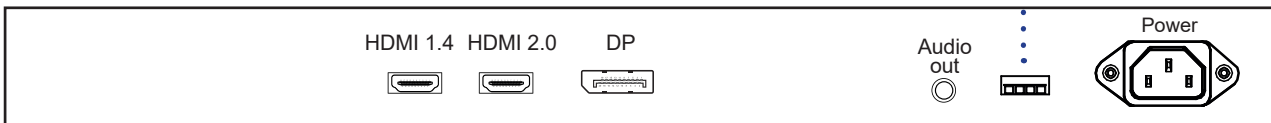

IR10 Driver



Connect the USB cable from the USB port on the LCD to a computer. The touch screen supports easy Plug-and-Play operations. There is no need to install additional drivers on the computer.

< 5.6 > Options : DC Power

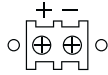



Model	24V	48V	125V
Input rating			
Input voltage:	24-Volt	48-Volt	110-Volt
Input range:	18 ~ 36V	36 ~ 75V	43 ~ 160V
Input current			
- No load	100 mA	50 mA	10 mA
- Full load	7386 mA	3611 mA	1540 mA
Output rating			
Output voltage:	24-Volt	24-Volt	24-Volt
Output current:	6.25A	6.25A	6.25A
Efficiency	88%	90%	89%

*** For DC power option :

(1) If the unit with LCD, earthing may be required 

	Input	Part no.	MIL Standard
MIL - type Connector	DC Power *** (Male)	MS3470W8-33P 	MIL - DTL - 26482
	VGA *** (Male)	MS3470W14-15P 	MIL - DTL - 26482

*** There are several additional MIL DC and VGA connector types with varying design characteristics to meet cost considerations and to provide users with the most design flexibility possible. For more information, please contact us.

	Input	Part no.	Standard
Lockable Connector	DC Power (Male)	YM-Ext-461CP001 	D-type 3W3
	USB	LUSB - A111 - 00 	-

*** MIL - type or Lockable connectors above can be integrated with our LCD displays. Sale service just for connectors not provided.

< 5.8 > Options : Quad Display

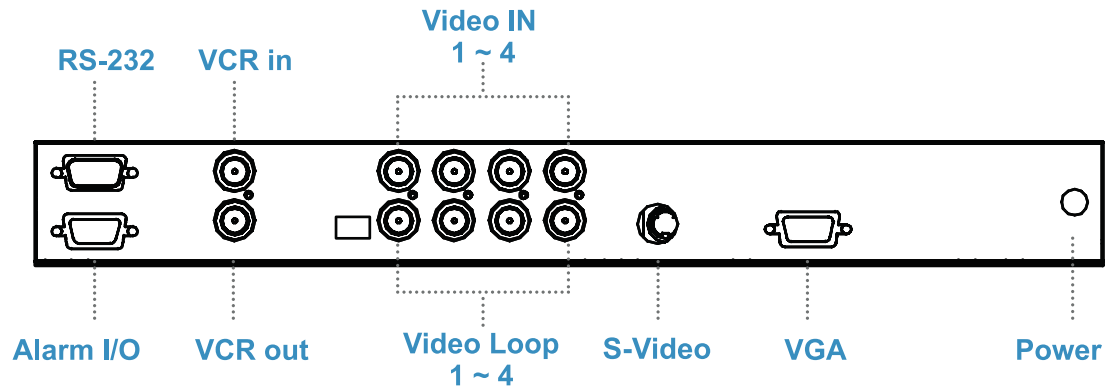

QD Specification

Item	Description
Model Number	QD (NTSC) QD (PAL)
Number of Color	16.7 M 16.7 M
Imaging System	NTSC PAL
Resolution	1024 x 525 1024 x 625
Refresh Rate	60 50
Video Input	Camera Input 1.0 Vpp, 75 Ohm x 4
	VCR Input 1.0 Vpp, 75 Ohm x 1
Video Output	Live Monitor 1.0 Vpp, 75 Ohm x 1
	Loop Through Out 1.0 Vpp, 75 Ohm x 4
	VCR Output 1.0 Vpp, 75 Ohm x 1
Auto Gain Control	Yes
Time / Date	Yes
On Screen Display	Yes
Camera Title	8 Character Title
Display Format	2 x Zoom On Playback Yes
	QUAD Yes
	FULL Yes
	SEQUENCY Yes
Dwell Time	0 to 99 Sec Adjustable
Alarm Inputs	Selectable NO/NC Contacts x 4
Relay Outputs	NO/NC contacts x 1: 1A @DC24V Max.
Alarm Hold Time	1 Sec to Non-stop
Built-in Buzzer	Yes
Key Lock	Yes

< 5.9 > Options for Sunlight Readable : Auto Dimming 55" 4K LCD Display

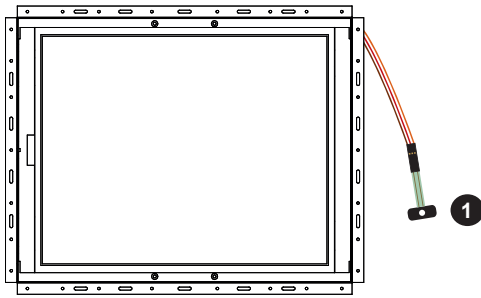

① DA-01 Light sensor on **OP** model
(66cm from AD board to sensor end)

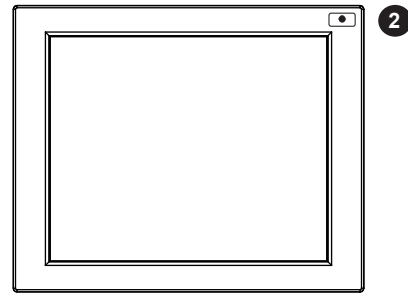

② DA-01 Light sensor on **AP** model

DA-01 light sensor installed on the display front panel. Users can set auto dimming ON or OFF from OSD menu. Then display brightness changes according to its ambient brightness. Each change causes 10% increase or decrease on display brightness.

Once the auto dimming is ON, users cannot adjust brightness from OSD menu.

Steps : OSD Menu > Picture > Auto Dimming > ON

Light Sensor Operation Range

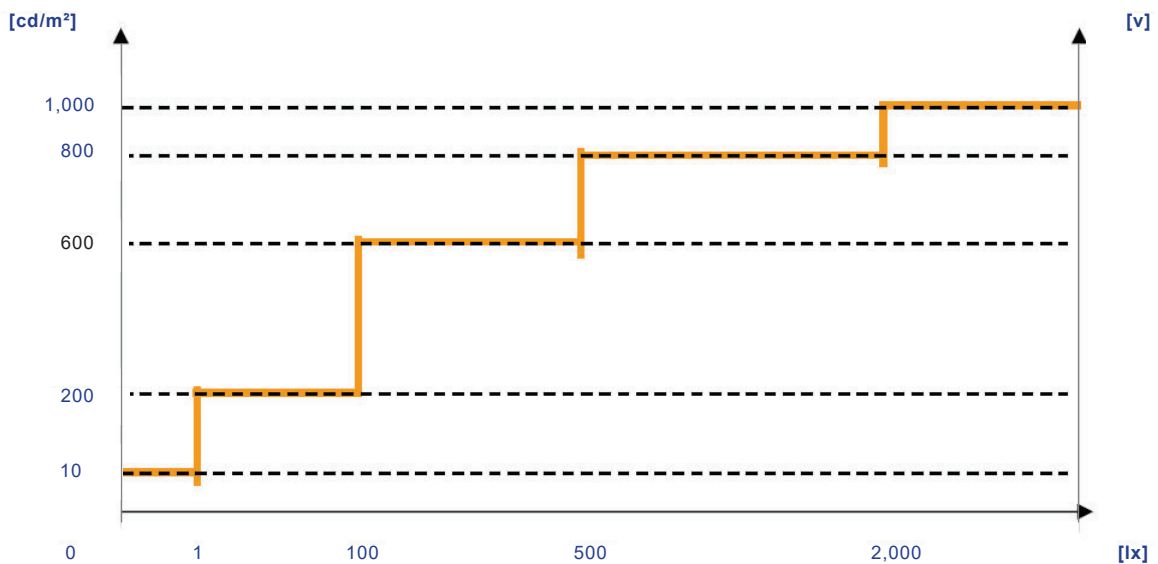

Options : Switch Dimming

DS-01 is a IP54 dimming knob installed on the bottom right side of the front panel. The display can support hyper dimming function to adjust brightness from nearly 0% to 100% via the easy-to-use knob. One click on dimming knob causes 2% increase or decrease on display brightness.

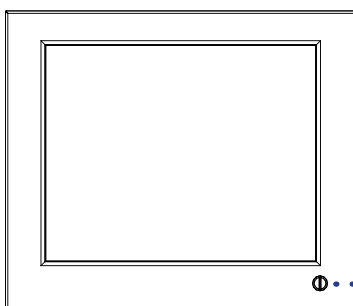

DS-01 dimming knob
Dimensions (W x H) : 15.5 x 14.2 mm

- For this option, front panel and casing dimensions may be changed.
- For HAP series, if DS-01 dimming knob applied, IP protection will be downgraded from IP65 to IP54.

< 6 > Ultraview K55 Family

450 cd/m² Brightness

8mm aluminum front bezel



AP-K55

8mm aluminum front bezel 
NEMA 4 / IP65 front protection



NAP-K55

Aluminum front cover

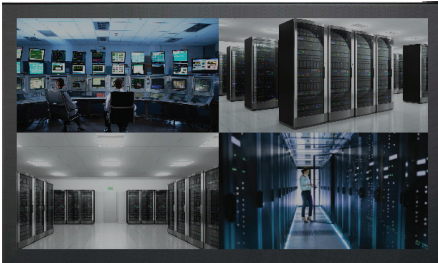

DP-K55

Universal open frame



OP-K55

MP-K55

Industrial Display Kit

- 4K 55" LED
- LCD controller
- AC power

700 cd/m² Sunlight Readable Brightness

8mm aluminum front bezel



HAP-K55

8mm aluminum front bezel 
NEMA 4 / IP65 front protection



HNAP-K55

Aluminum front cover



HDP-K55

Universal open frame



HOP-K55

Intentionally
Left
Blank

The company reserves the right to modify product specifications without prior notice and assumes no responsibility for any error which may appear in this publication.

All brand names, logo and registered trademarks are properties of their respective owners.

Copyright 2022 Austin Hughes Electronics Ltd. All rights reserved.