



CH-1527TXPLV & CH-1527RXPLV

4K UHD+ HDMI over HDBaseT
Transmitter (PSE) & Receiver (PD)



Operation Manual



HDMI[®]
HIGH-DEFINITION MULTIMEDIA INTERFACE

The terms HDMI, HDMI High-Definition Multimedia Interface, and the HDMI Logo are trademarks or registered trademarks of HDMI Licensing Administrator, Inc.

DISCLAIMERS

The information in this manual has been carefully checked and is believed to be accurate. Cypress Technology assumes no responsibility for any infringements of patents or other rights of third parties which may result from its use.

Cypress Technology assumes no responsibility for any inaccuracies that may be contained in this document. Cypress also makes no commitment to update or to keep current the information contained in this document.

Cypress Technology reserves the right to make improvements to this document and/or product at any time and without notice.

COPYRIGHT NOTICE

No part of this document may be reproduced, transmitted, transcribed, stored in a retrieval system, or any of its part translated into any language or computer file, in any form or by any means—electronic, mechanical, magnetic, optical, chemical, manual, or otherwise—without express written permission and consent from Cypress Technology.

© Copyright 2018 by Cypress Technology.

All Rights Reserved.

TRADEMARK ACKNOWLEDGMENTS

All products or service names mentioned in this document are trademarks of the companies with which they are associated.



SAFETY PRECAUTIONS

Please read all instructions before attempting to unpack, install or operate this equipment and before connecting the power supply. Please keep the following in mind as you unpack and install this equipment:

- Always follow basic safety precautions to reduce the risk of fire, electrical shock and injury to persons.
- To prevent fire or shock hazard, do not expose the unit to rain, moisture or install this product near water.
- Never spill liquid of any kind on or into this product.
- Never push an object of any kind into this product through any openings or empty slots in the unit, as you may damage parts inside the unit.
- Do not attach the power supply cabling to building surfaces.
- Use only the supplied power supply unit (PSU). Do not use the PSU if it is damaged.
- Do not allow anything to rest on the power cabling or allow any weight to be placed upon it or any person walk on it.
- To protect the unit from overheating, do not block any vents or openings in the unit housing that provide ventilation and allow for sufficient space for air to circulate around the unit.
- Please completely disconnect the power when the unit is not in use to avoid wasting electricity.

VERSION HISTORY

REV.	DATE	SUMMARY OF CHANGE
RDV1	2017/12/26	Preliminary release
VS1	2018/01/09	Final technical review
VS2	2018/01/22	Updated package contents
VS3	2018/06/20	Updated section 6.1

CONTENTS

1. Introduction	1
2. Applications	1
3. Package Contents	1
4. System Requirements	2
5. Features	2
6. Operation Controls and Functions	3
6.1 Transmitter's Front Panel	3
6.2 Transmitter's Rear Panel	4
6.3 Receiver's Front Panel	4
6.4 Receiver's Rear Panel.....	5
6.5 IR Pin Assignment	6
6.6 RS-232 Protocol	6
7. Connection Diagram	7
8. Specifications	8
8.1 Transmitter's Technical Specifications	8
8.2 Receiver's Technical Specifications	9
8.3 Video Specifications	10
8.4 Cable Specifications	12
9. Acronyms	13





1. INTRODUCTION

This transmitter and receiver set is a great solution for extending UHD video and audio as well as Ethernet and control via a single run of Cat.5e/6/7 cable over distances up to 70 meters. This extender set complies with the advanced HDCP 2.2 and HDMI 2.0 standards, as well as supporting the legacy HDCP 1.x and HDMI 1.x standards. Despite HDBaseT's 10.2Gbps bandwidth limitation, 4K UHD HDMI video sources, up to and including 4K@60Hz (4:4:4, 8-bit) as well as 10/12-bit sources with HDR, are able to be processed and extended by the use of AVLC (Adaptive Visually Lossless Compression) when needed. Multiple data and control interfaces are also provided, including IR and RS-232 connections. The Receiver (PD) is powered by 48V PoH (Power over HDBaseT) provided by the Transmitter (PSE), allowing for greater flexibility within different installation scenarios.

2. APPLICATIONS

- Household entertainment sharing and control
- Lecture room display and control
- Showroom display and control
- Meeting room presentation and control
- Classroom display and control

3. PACKAGE CONTENTS

Transmitter

- 1×HDMI over HDBaseT Transmitter (with IR & RS-232)
- 1×48V/0.83A DC Power Adapter
- 1×Power Cord
- 1×3.5mm to IR Blaster Cable
- 1×Operation Manual

Receiver

- 1×HDMI over HDBaseT Receiver (with IR & RS-232)
- 1×3.5mm to IR Extender Cable
- 1×Operation Manual

4. SYSTEM REQUIREMENTS

- HDMI source equipment such as a media player, video game console or set-top box.
- HDMI receiving equipment such as an HDTV, monitor or audio amplifier.
- The use of “Premium High Speed HDMI” cables, and industry standard Cat.6, Cat.6a or Cat.7, is highly recommended.

5. FEATURES

- HDMI with HDR, 3D & 4K@60Hz support, DVI 1.0 compatible
- HDCP 2.2 and HDCP 1.x compliant
- Supports up to 4K UHD (18Gbps, 4K@50/60Hz 4:4:4, 8-bit) video input
- Supports output resolutions up to 4K@50/60Hz (4:4:4, 8-bit)
- Supports Deep Color input and output up to 12-bit
- Supports 10-bit and 12-bit HDR bypass
- Supports CEC bypass
- Simultaneous transmission of video, audio and data over a single Cat.5e/6/7 cable up to 70m (230ft) at 1080p and 35m (115ft) at 4K
- Supported HDBaseT feature set: HD Video & Audio, 48V PoH, and Control (Bi-directional IR/RS-232 pass-through)
- Integrated AVLC (Adaptive Visually Lossless Compression) activates when the bandwidth requirements of the source are beyond 10.2Gbps (340MHz) allowing for support of sources up to 18Gbps (600MHz) with no loss of visual quality
- The AVLC function allows manual selection between High Quality (Full bandwidth) mode and Standard mode (Lower bandwidth, useful for longer cable runs with 4K sources)
- Supports standard IEEE 802.3 AT 48V PoH from Transmitter (PSE) to Receiver (PD) (compatible Receivers only)

Note: The 48V PoH function is designed for powering compatible Receiver units only. Non-PoH Receivers will need their own power supply. Receivers from other brands may not be compatible.

6. OPERATION CONTROLS AND FUNCTIONS

6.1 Transmitter's Front Panel

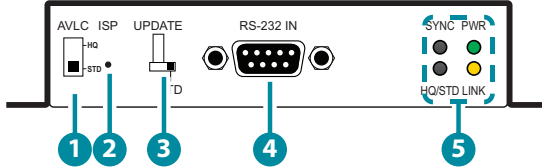

- 1 STD/HQ:** This switch allows the user to select which compression mode to use when AVLC is active.

HQ (High Quality) mode uses the least amount of compression and provides the highest possible visual quality (perceptually identical to the original). In this mode, AVLC compression activates for any signal requiring more than 9Gbps.

STD (Standard Quality) mode applies additional signal reduction methods to lower the bandwidth requirements even further, improving transmission reliability at the cost of some visual fidelity. In this mode, AVLC compression activates for any signal requiring more than 7.5Gbps.

- 2 ISP:** This button is reserved for factory use only.
- 3 STD/UPDATE:** This switch is reserved for factory use only. The default setting is "STD".
- 4 RS-232 IN:** Connect to a PC, laptop or other serial control device for the extension of RS-232 signals.
- 5 SYNC LED:** This LED will illuminate when a live input source is detected.
HQ/STD LED: This LED will illuminate whenever the AVLC function is active. A green LED indicates that AVLC is in HQ (High Quality) mode. A red LED indicates that AVLC is in STD (Standard) mode.
POWER LED: This LED will illuminate to indicate the unit is on and receiving power.
LINK LED: This LED will illuminate solidly when a live connection with a compatible Receiver is active. The LED will blink with a regular pattern if a Receiver is connected but there is not currently a live signal. The LED will blink with an irregular pattern if a connection error has occurred.

6.2 Transmitter's Rear Panel

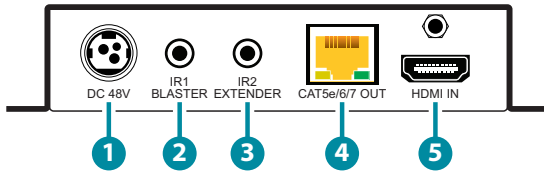

- 1 **DC 48V:** Plug the 48V DC power adapter into this port and connect it to an AC wall outlet for power.
- 2 **IR1 BLASTER:** Connect to the provided IR Blaster to transmit IR signals to devices within direct line-of-sight of the IR Blaster.
- 3 **IR2 EXTENDER:** Connect to the provided IR Extender to extend the IR control range of remotely located devices. Ensure that the remote being used is within direct line-of-sight of the IR Extender.
- 4 **CAT5e/6/7 OUT:** Connect to a compatible HDBaseT Receiver with a single Cat.5e/6/7 cable for transmission of all data signals.
- 5 **HDMI IN:** Connect to HDMI source equipment such as a media player, game console or set-top box.

6.3 Receiver's Front Panel

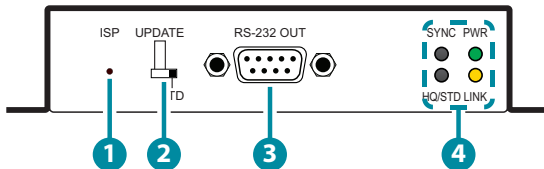

- 1 **ISP:** This button is reserved for factory use only.
- 2 **STD/UPDATE:** This switch is reserved for factory use only. The default setting is "STD".
- 3 **RS-232 OUT:** Connect to a serial controllable device for the extension of RS-232 signals.
- 4 **SYNC LED:** This LED will illuminate when a live input source is detected.
HQ/STD LED: This LED will illuminate whenever the AVLC function is active. A green LED indicates that AVLC is in HQ (High Quality) mode. A red LED indicates that AVLC is in STD (Standard) mode.
POWER LED: This LED will illuminate to indicate the unit is on and receiving power.

LINK LED: This LED will illuminate solidly when a live connection with a compatible Receiver is active. The LED will blink with a regular pattern if a Receiver is connected but there is not currently a live signal. The LED will blink with an irregular pattern if a connection error has occurred.

6.4 Receiver's Rear Panel

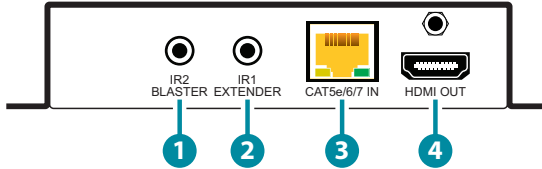

- 1 IR2 BLASTER:** Connect to the provided IR Blaster to transmit IR signals to devices within direct line-of-sight of the IR Blaster.
- 2 IR1 EXTENDER:** Connect to the provided IR Extender to extend the IR control range of remotely located devices. Ensure that the remote being used is within direct line-of-sight of the IR Extender.
- 3 CAT5e/6/7:** Connect to a compatible HDBaseT Transmitter with a single Cat.5e/6/7 cable for transmission of all data signals.
- 4 HDMI OUT:** Connect to an HDMI TV, monitor or amplifier for digital video and audio output.

6.5 IR Pin Assignment

IR Blaster Cable

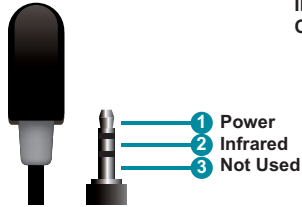

IR Extender Cable

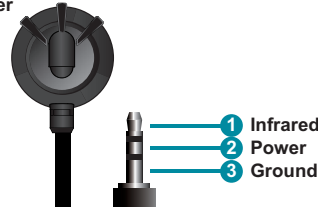

6.6 RS-232 Protocol

UNIT		TERMINAL	
Pin	Pinout	Pin	Pinout
1		1	
2	TxD	2	RxD
3	RxD	3	TxD
4		4	
5	GND	5	GND
6		6	
7		7	
8		8	
9		9	

7. CONNECTION DIAGRAM

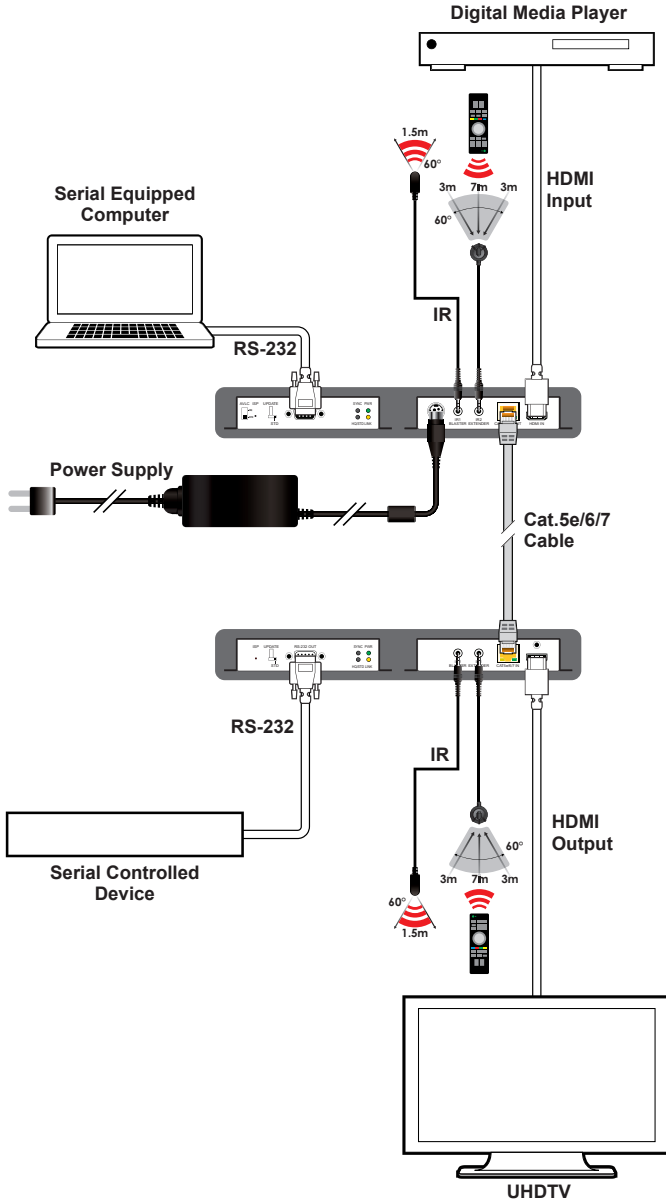

8. SPECIFICATIONS

8.1 Transmitter's Technical Specifications

HDMI Bandwidth	600MHz/18Gbps
HDBaseT Bandwidth	340MHz/10.2Gbps
Input Ports	1×HDMI
Output Ports	1×Cat.5e/6/7
Pass-through Ports	1×IR Extender [3.5mm] 1×IR Blaster [3.5mm] 1×RS-232 [9-pin D-sub]
IR Frequency	30 - 50kHz (30 - 60kHz under ideal conditions)
Baud Rate	Up to 115200bps
Power Supply	48V/0.83A DC (US/EU standards, CE/FCC/UL certified)
ESD Protection	Human Body Model: ±8kV (Air Discharge) ±4kV (Contact Discharge)
Dimensions	128mm×25mm×108mm (W×H×D) [Case Only] 128mm×25mm×117mm (W×H×D) [All Inclusive]
Weight	385g
Chassis Material	Metal
Silkscreen Color	Black
Operating Temperature	0°C - 40°C/32°F - 104°F
Storage Temperature	-20°C - 60°C/-4°F - 140°F
Relative Humidity	20 - 90% RH (Non-condensing)
Power Consumption	8.47W

8.2 Receiver's Technical Specifications

HDMI Bandwidth	600MHz/18Gbps
HDBaseT Bandwidth	340MHz/10.2Gbps
Input Ports	1×Cat.5e/6/7
Output Ports	1×HDMI
Pass-through Ports	1×IR Extender [3.5mm] 1×IR Blaster [3.5mm] 1×RS-232 [9-pin D-sub]
IR Frequency	30 - 50kHz (30 - 60kHz under ideal conditions)
Baud Rate	Up to 115200bps
Power Supply	PoH
ESD Protection	Human Body Model: ±8kV (Air Discharge) ±4kV (Contact Discharge)
Dimensions	128mm×25mm×108mm (W×H×D) [Case Only] 128mm×25mm×117mm (W×H×D) [All Inclusive]
Weight	386g
Chassis Material	Metal
Silkscreen Color	Black
Operating Temperature	0°C - 40°C/32°F - 104°F
Storage Temperature	-20°C - 60°C/-4°F - 140°F
Relative Humidity	20 - 90% RH (Non-condensing)
Power Consumption	9.8W

8.3 Video Specifications

Supported PC Resolutions (Hz)		HDMI Input	HDMI Output
640×480	60, 72, 75, 85	✓	✓
720×400	70, 85	✓	✓
800×600	56, 60, 72, 75, 85	✓	✓
1024×768	60, 70, 75, 85	✓	✓
1152×864	75	✓	✓
1280×720	50, 60	✓	✓
1280×768	60, 75, 85	✓	✓
1280×800	60, 60 (RB)	✓	✓
1280×960	60	✓	✓
1280×1024	60	✓	✓
1360×768	60	✓	✓
1366×768	60	✓	✓
1400×1050	60, 60 (RB)	✓	✓
1440×900	60, 60 (RB)	✓	✓
1600×900	60	✓	✓
1600×1200	60	✓	✓
1680×1050	60, 60 (RB)	✓	✓
1920×1080	60	✓	✓
1920×1200	60	✓	✓

Supported TV Resolutions (Hz)		HDMI Input	HDMI Output
720×480i	59.94, 60	✓	✓
720×576i	50	✓	✓
720×480p	59.94, 60	✓	✓
720×576p	50	✓	✓
1280×720p	50, 59.94, 60	✓	✓
1920×1080i	50, 59.94, 60	✓	✓
1920×1080p	50, 59.94, 60	✓	✓
1920×1080p	23.97, 24, 25, 29.97, 30	✓	✓
3840×2160p	24, 25, 30	✓	✓
4096×2160p	24, 25, 30	✓	✓
3840×2160p (YUV 4:2:0)	50, 60	✓	✓
3840×2160p	50, 60	✓	✓

8.4 Cable Specifications

HDMI Cable Length (meter)	1080p		4K
	8-bit	12-bit	8-bit
Input	10	10	5
Output	10	5	5

Cat. Cable Length (meter)	1080p	4K
Cat.5e	70	35
Cat.6	70	35
Cat.7	70	35

- **Full HD Video (1080p)**

- Up to 1080p@60Hz, 12-bit color
- Data rates lower than 5.3Gbps or below 225MHz TMDS clock

- **Ultra HD Video (4K)**

- 4K@24/25/30Hz & 4K@50/60Hz (YUV 4:2:0), 8-bit color
- 4K@50/60Hz (4:4:4, 8-bit) with AVLC active
- Data rates higher than 5.3Gbps or above 225MHz TMDS clock

9. ACRONYMS

ACRONYM	COMPLETE TERM
AVLC	Adaptive Visually Lossless Compression
Cat.5e	Category 5 (enhanced) Cable
Cat.6	Category 6 Cable
Cat.7	Category 7 Cable
CEC	Consumer Electronics Control
DVI	Digital Visual Interface
HD	High-Definition
HDCP	High-bandwidth Digital Content Protection
HDMI	High-Definition Multimedia Interface
HDR	High Dynamic Range
IR	Infrared
LAN	Local Area Network
LPCM	Linear Pulse-Code Modulation
PC	Personal Computer
PD	Powered Device
PoH	Power over HDBaseT
PSE	Power Sourcing Equipment
UHD	Ultra-High-Definition



CYPRESS TECHNOLOGY CO., LTD.
www.cypress.com.tw
