



HDMI[®]
HIGH-DEFINITION MULTIMEDIA INTERFACE

The terms HDMI, HDMI High-Definition Multimedia Interface, and the HDMI Logo are trademarks or registered trademarks of HDMI Licensing Administrator, Inc.

DISCLAIMERS

The information in this manual has been carefully checked and is believed to be accurate. Cypress Technology assumes no responsibility for any infringements of patents or other rights of third parties which may result from its use.

Cypress Technology assumes no responsibility for any inaccuracies that may be contained in this document. Cypress also makes no commitment to update or to keep current the information contained in this document.

Cypress Technology reserves the right to make improvements to this document and/or product at any time and without notice.

COPYRIGHT NOTICE

No part of this document may be reproduced, transmitted, transcribed, stored in a retrieval system, or any of its part translated into any language or computer file, in any form or by any means—electronic, mechanical, magnetic, optical, chemical, manual, or otherwise—without express written permission and consent from Cypress Technology.

© Copyright 2018 by Cypress Technology.

All Rights Reserved.

TRADEMARK ACKNOWLEDGMENTS

All products or service names mentioned in this document are trademarks of the companies with which they are associated.



SAFETY PRECAUTIONS

Please read all instructions before attempting to unpack, install or operate this equipment and before connecting the power supply. Please keep the following in mind as you unpack and install this equipment:

- Always follow basic safety precautions to reduce the risk of fire, electrical shock and injury to persons.
- To prevent fire or shock hazard, do not expose the unit to rain, moisture or install this product near water.
- Never spill liquid of any kind on or into this product.
- Never push an object of any kind into this product through any openings or empty slots in the unit, as you may damage parts inside the unit.
- Do not attach the power supply cabling to building surfaces.
- Use only the supplied power supply unit (PSU). Do not use the PSU if it is damaged.
- Do not allow anything to rest on the power cabling or allow any weight to be placed upon it or any person walk on it.
- To protect the unit from overheating, do not block any vents or openings in the unit housing that provide ventilation and allow for sufficient space for air to circulate around the unit.
- Please completely disconnect the power when the unit is not in use to avoid wasting electricity.

VERSION HISTORY

REV.	DATE	SUMMARY OF CHANGE
RDV1	2021/06/24	Preliminary release



CONTENTS

1. Introduction	1
2. Applications	1
3. Package Contents	1
4. System Requirements	2
5. Features	2
6. Operation Controls and Functions	3
6.1 Front Panel (Transmitter)	3
6.2 Rear Panel (Transmitter)	4
6.3 Front Panel (Receiver)	5
6.4 Rear Panel (Receiver).....	6
6.5 RS-232 Pinout	7
6.6 IR Pinout.....	7
7. Connection Diagram	8
8. Specifications	9
8.1 Technical Specifications (Transmitter).....	9
8.2 Technical Specifications (Receiver).....	10
8.3 Video Specifications	11
8.4 Audio Specifications	13
8.4.1 Digital Audio	13
8.4.2 Analog Audio	13
8.5 Cable Specifications	14
8.6 HDBaseT Features.....	15
9. Acronyms	16



1. INTRODUCTION

This 4K UHD HDMI over HDBaseT transmitter and receiver pair uses HDBaseT 2.0 technology, and is the perfect solution for extending high bandwidth HDMI 4K@60Hz (4:2:0, 8-bit) video (10.2Gbps) with HD audio via a single run of Cat.6A/7 cable over distances of up to 40 meters. Multiple control and data signals may also be transmitted along with the HD audio and video, including bi-directional IR, RS-232, bi-directional analog audio, and USB 2.0.

When the transmitter and receiver are used together, the USB 2.0 Type-B port on the transmitter can connect a single USB host (such as a laptop or PC) to devices on up to 5 USB 2.0 (Type-A) ports (2 on the transmitter, 3 on the receiver) forming a highly powerful KVM extension configuration. Additionally, the receiver is powered by PoH (Power over HDBaseT) provided by the transmitter, allowing for greater flexibility within different installation scenarios. This transmitter and receiver pair is ideal for use in any video extension scenario, but they excel when latency-free, uncompressed, high resolution video

2. APPLICATIONS

- Household entertainment sharing and control
- Lecture hall/classroom display and control
- Meeting room presentation and control

3. PACKAGE CONTENTS

Transmitter

- 1× UHD HDMI/USB to HDBaseT Transmitter
- 1× 24V/2.7A DC Power Adapter
- 1× 3-pin Terminal Block
- 1x 4-pin Terminal Block
- 1× Operation Manual

Receiver

- 1× UHD HDBaseT to HDMI/USB Receiver
- 1× 3-pin Terminal Block
- 1x 4-pin Terminal Block
- 1× Operation Manual

4. SYSTEM REQUIREMENTS

- HDMI source equipment such as a media player, video game console, or set-top box.
- HDMI receiving equipment such as an HDTV, monitor, or audio amplifier.
- The use of Premium High Speed HDMI cables, and industry standard Cat.6A or Cat.7 Ethernet cable is highly recommended.

5. FEATURES

- HDMI 2.0 and DVI 1.0 compatible
- HDCP 2.2 and HDCP 1.x compliant
- HDBaseT 2.0 compliant (Backwards compatible with 1.0)
- 1 HDMI input and 1 HDBaseT output (Transmitter)
- 1 HDMI output, and 1 HDBaseT input (Receiver)
- Supports up to 4K UHD (10.2Gbps, 4K@60Hz 4:2:0, 8-bit) video input and output over both HDMI and HDBaseT
- Supports Deep Color input and output up to 12-bit
- Supports CEC bypass
- HDBaseT extends video, audio and data over a single Cat.6A/7 cable and can reach distances up to 40m/131ft
- HDBaseT feature support: HD Video and Audio, PoH (Tx to Rx), Bi-directional audio (analog), and Control (bi-directional USB/IR/RS-232 pass-through)
- 2 USB 2.0 Type-A device ports and 1 USB 2.0 Type-B host port (Transmitter)
- 3 USB 2.0 Type-A device ports (Receiver)
- Supports pass-through of digital audio formats including 8 channel LPCM, Bitstream and HD Bitstream
- Selectable stereo/microphone analog audio bypass functionality
- Transmitter can supply PoH to the connected receiver
- Receiver is powered directly via PoH from the connected transmitter

Note: A compatible PSE transmitter providing PoH is required to power this receiver. Transmitters from other brands may not be compatible.

6. OPERATION CONTROLS AND FUNCTIONS

6.1 Front Panel (Transmitter)

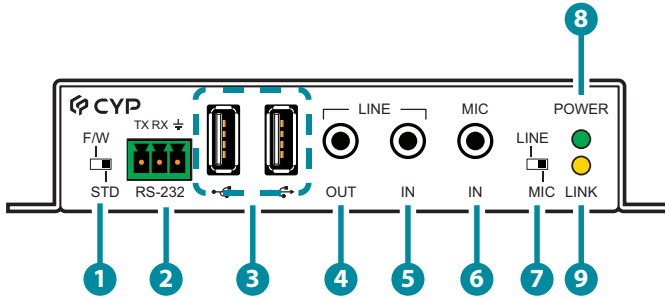

- 1 F/W & STD Switch:** Move this switch to toggle the RS-232 port's functionality between firmware update and RS-232 bypass mode. The default setting is "STD" (RS-232 Bypass).
- 2 RS-232 3-pin Terminal Block:** Connect to a PC, laptop, or serial controllable device with a 3-pin adapter cable for the extension of RS-232 signals between both ends of the HDBaseT connection.
- 3 USB 2.0 Ports (Type-A):** Connect directly to standard USB devices such as a mouse, keyboard, or flash drive to extend their USB functionality to the local USB (Type-B) host port.
- 4 LINE OUT Port:** Connect to powered speakers or an amplifier for analog audio output. Audio is sourced from the analog audio input on the connected compatible receiver.
- 5 LINE IN Port:** Connect to the analog audio output of a device such as a media player or game console. Audio is sent to the analog audio output on the connected compatible receiver.
- 6 MIC IN Port:** Connect to a standard unpowered microphone using a 3.5mm plug.
- 7 LINE & MIC Switch:** Move this switch to toggle the analog audio source to send to the other end of the HDBaseT connection between LINE IN or MIC IN. The default setting is "LINE".
- 8 POWER LED:** This LED will illuminate to indicate the unit is on and receiving power.
- 9 LINK LED:** This LED will illuminate solidly when a live connection with a compatible receiver is active.

6.2 Rear Panel (Transmitter)

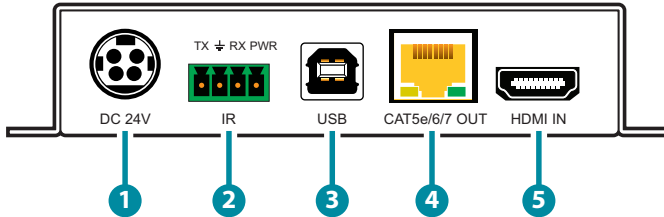

- 1 **DC 24V:** Plug the 24V DC power adapter into this port and connect it to an AC wall outlet for power.
- 2 **IR 4-pin Terminal Block (In/Out):** Connect to both an IR Blaster and Extender using a 4-pin Y-adapter cable to transmit and receive IR control signals and extend them to devices connected to the other end of the HDBaseT connection.
- 3 **USB 2.0 Port (Type-B):** Connect directly to a standard USB host such as a PC or laptop to extend their USB functionality to all currently connected USB devices on both ends of the HDBaseT connection.
- 4 **CAT5e/6/7 OUT Port:** Connect to a compatible HDBaseT receiver with a single Cat.6A/7 cable for extension of all data signals. PoH will also be supplied to a connected compatible PD receiver.
Note: The PoH function is designed for powering compatible receiver units only. Non-PoH receivers will need their own power supply. Receivers from other brands may not be compatible.
- 5 **HDMI IN Port:** Connect to HDMI source equipment such as a media player, game console, or set-top box.

6.3 Front Panel (Receiver)

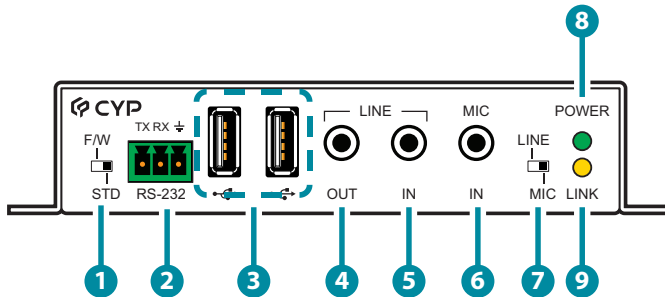

- 1 F/W & STD Switch:** Move this switch to toggle the RS-232 port's functionality between firmware update and RS-232 bypass mode. The default setting is "STD" (RS-232 Bypass).
- 2 RS-232 3-pin Terminal Block:** Connect to a PC, laptop, or serial controllable device with a 3-pin adapter cable for the extension of RS-232 signals between both ends of the HDBaseT connection.
- 3 USB 2.0 Ports (Type-A):** Connect directly to standard USB devices such as a mouse, keyboard, or flash drive to extend their USB functionality to the USB (Type-B) host port on the connected transmitter.
- 4 LINE IN Port:** Connect to the analog audio output of a device such as a media player or game console. Audio is sent to the analog audio output on the connected compatible transmitter.
- 5 LINE OUT Port:** Connect to powered speakers or an amplifier for analog audio output. Audio is sourced from the analog audio input on the connected compatible transmitter.
- 6 MIC IN Port:** Connect to a standard unpowered microphone using a 3.5mm plug.
- 7 LINE & MIC Switch:** Move this switch to toggle the analog audio source to send to the other end of the HDBaseT connection between LINE IN or MIC IN. The default setting is "LINE".
- 8 POWER LED:** This LED will illuminate to indicate the unit is on and receiving power.
- 9 LINK LED:** This LED will illuminate solidly when a live connection with a compatible receiver is active.

6.4 Rear Panel (Receiver)

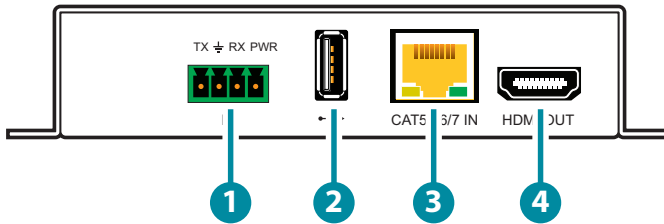

- 1 IR 4-pin Terminal Block (In/Out):** Connect to both an IR Blaster and Extender using a 4-pin Y-adapter cable to transmit and receive IR control signals and extend them to devices connected to the other end of the HDBaseT connection.
- 2 USB 2.0 Port (Type-A):** Connect directly to a standard USB device such as a mouse, keyboard, or flash drive to extend their USB functionality to the USB (Type-B) host port on the connected transmitter.
- 3 CAT5e/6/7 IN Port:** Connect to a compatible HDBaseT transmitter with a single Cat.6A/7 cable for extension of all data signals. Power via PoH will also be supplied to this unit when connected to a compatible PSE transmitter.

Note: A compatible PoH (PSE) transmitter is REQUIRED to power this receiver.
- 4 HDMI OUT Port:** Connect to an HDMI TV, monitor, or amplifier for digital video and audio output.

6.5 RS-232 Pinout

4-pin Terminal Block

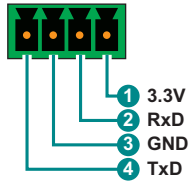

6.6 IR Pinout

3-pin Terminal Block

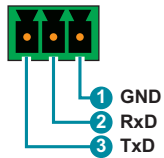

7. CONNECTION DIAGRAM

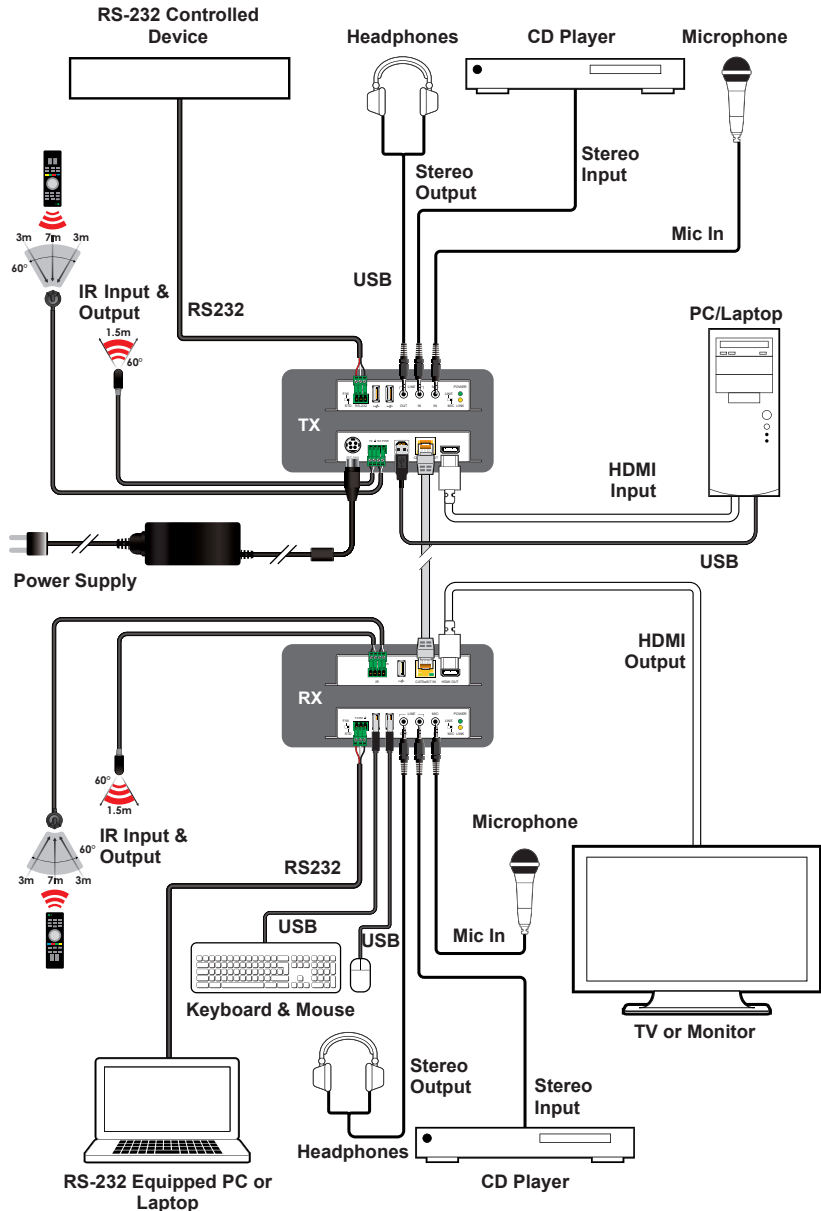

8. SPECIFICATIONS

8.1 Technical Specifications (Transmitter)

HDMI Bandwidth	18Gbps
HDBaseT Bandwidth	10.2Gbps
Input Ports	1×HDMI (Type-A) 1×Stereo Analog Audio (3.5mm) 1×Microphone (3.5mm)
Output Ports	1×HDBaseT (RJ-45) 1×Stereo Analog Audio (3.5mm)
Pass-through Ports	1×IR Tx/Rx (4-pin Terminal Block) 1×RS-232 (3-pin Terminal Block) 2×USB 2.0 (Type-A)
Pass-through/Service Port	1×USB 2.0 (Type-B)
IR Frequency	30 ~ 50kHz (30 ~ 60kHz under ideal conditions)
Baud Rate	Up to 115200
Power Supply	24V/2.7A DC (US/EU standards, CE/FCC/UL certified)
ESD Protection (HBM)	±8kV (Air Discharge) ±4kV (Contact Discharge)
Dimensions (W×H×D)	128mm×25mm×108mm [Case Only] 128mm×25mm×113.6mm [All Inclusive]
Weight	410g
Chassis Material	Metal (Steel)
Chassis Color	Black
Operating Temperature	0°C – 50°C/32°F – 122°F
Storage Temperature	-20°C – 60°C/-4°F – 140°F
Relative Humidity	20 – 90% RH (Non-condensing)
Power Consumption	4.5W

8.2 Technical Specifications (Receiver)

HDMI Bandwidth	18Gbps
HDBaseT Bandwidth	10.2Gbps
Input Ports	1×HDBaseT (RJ-45) 1×Stereo Analog Audio (3.5mm) 1×Microphone (3.5mm)
Output Ports	1×HDMI (Type-A) 1×Stereo Analog Audio (3.5mm)
Pass-through Ports	1×IR Tx/Rx (4-pin Terminal Block) 1×RS-232 (3-pin Terminal Block) 3×USB 2.0 (Type-A)
IR Frequency	30 ~ 50kHz (30 ~ 60kHz under ideal conditions)
Baud Rate	Up to 115200
Power Supply	PoH from the Tx
ESD Protection (HBM)	±8kV (Air Discharge) ±4kV (Contact Discharge)
Dimensions (W×H×D)	128mm×25mm×108mm [Case Only] 128mm×25mm×111mm [All Inclusive]
Weight	392g
Chassis Material	Metal (Steel)
Chassis Color	Black
Operating Temperature	0°C – 50°C/32°F – 122°F
Storage Temperature	-20°C – 60°C/-4°F – 140°F
Relative Humidity	20 – 90% RH (Non-condensing)
Power Consumption	7.9W

8.3 Video Specifications

Supported Resolutions (Hz)	Input		Output	
	HDMI	HDBT	HDMI	HDBT
720×400p@70/85	✓	✓	✓	✓
640×480p@60/72/75/85	✓	✓	✓	✓
720×480i@60	✓	✓	✓	✓
720×480p@60	✓	✓	✓	✓
720×576i@50	✓	✓	✓	✓
720×576p@50	✓	✓	✓	✓
800×600p@56/60/72/75/85	✓	✓	✓	✓
848×480p@60	✓	✓	✓	✓
1024×768p@60/70/75/85	✓	✓	✓	✓
1152×864p@75	✓	✓	✓	✓
1280×720p@50/60	✓	✓	✓	✓
1280×768p@60/75/85	✓	✓	✓	✓
1280×800p@60/75/85	✓	✓	✓	✓
1280×960p@60/85	✓	✓	✓	✓
1280×1024p@60/75/85	✓	✓	✓	✓
1360×768p@60	✓	✓	✓	✓
1366×768p@60	✓	✓	✓	✓
1400×1050p@60	✓	✓	✓	✓
1440×900p@60/75	✓	✓	✓	✓
1600×900p@60RB	✓	✓	✓	✓
1600×1200p@60	✓	✓	✓	✓
1680×1050p@60	✓	✓	✓	✓
1920×1080i@50/60	✓	✓	✓	✓
1920×1080p@24/25/30	✓	✓	✓	✓

Supported Resolutions (Hz)	Input		Output	
	HDMI	HDBT	HDMI	HDBT
1920×1080p@50/60	✓	✓	✓	✓
1920×1200p@60RB	✓	✓	✓	✓
2560×1440p@60RB	✓	✓	✓	✓
2560×1600p@60RB	✓	✓	✓	✓
2048×1080p@24/25/30	✓	✓	✓	✓
2048×1080p@50/60	✓	✓	✓	✓
3840×2160p@24/25/30	✓	✓	✓	✓
3840×2160p@50/60 (4:2:0)	✓	✓	✓	✓
3840×2160p@24, HDR10	x	x	x	x
3840×2160p@50/60 (4:2:0),HDR10	x	x	x	x
3840×2160p@50/60	x	x	x	x
4096×2160p@24/25/30	✓	✓	✓	✓
4096×2160p@50/60 (4:2:0)	✓	✓	✓	✓
4096×2160p@24, HDR10	x	x	x	x
4096×2160p@50/60 (4:2:0),HDR10	x	x	x	x
4096×2160p@50/60	x	x	x	x

8.4 Audio Specifications

8.4.1 Digital Audio

HDMI Input / Output	
LPCM	
Max Channels	8 Channels
Sampling Rate (kHz)	32, 44.1, 48, 88.2, 96, 176.4, 192
Bitstream	
Supported Formats	Standard & High-Definition

8.4.2 Analog Audio

Analog Input (Stereo)	
Max Audio Level	2Vrms
Impedance	10k Ω
Type	Unbalanced
Analog Input (Microphone)	
Max Audio Level	20Vrms
Impedance	20k Ω
Type	Unbalanced
Analog Output	
Max Audio Level	2Vrms
THD+N	< -80dB@0dBFS 1kHz (A-wt)
SNR	> 93dB@0dBFS
Frequency Response	< ± 0.5 dB@20Hz~20kHz
Crosstalk	< -71dB@10kHz
Impedance	500 Ω
Type	Unbalanced

8.5 Cable Specifications

Cable Length	1080p		4K30	4K60
	8-bit	12-bit	(4:4:4) 8-bit	(4:4:4) 8-bit
High Speed HDMI Cable				
HDMI Input	10m	10m	5m	×
HDMI Output	10m	10m	5m	×
Ethernet Cable				
Cat.5e/6	60m		35m	×
Cat.6A/7	70m		40m	×

Bandwidth Category Examples:

- **1080p (FHD Video)**
 - Up to 1080p@60Hz, 12-bit color
 - Data rates lower than 5.3Gbps or below 225MHz TMDS clock
- **4K30 (4K UHD Video)**
 - 4K@24/25/30Hz & 4K@50/60Hz (4:2:0), 8-bit color
 - Data rates higher than 5.3Gbps or above 225MHz TMDS clock but below 10.2Gbps
- **4K60 (4K UHD⁺ Video)**
 - 4K@50/60Hz (4:4:4, 8-bit)
 - 4K@50/60Hz (4:2:0, 10-bit HDR)
 - Data rates higher than 10.2Gbps

8.6 HDBaseT Features

HDBaseT Feature Set	Transmitter
Video & Audio Extension	Supported
LAN Extension	Unsupported
Send power to Receiver	Supported (PoH)
Accept power from Receiver	Unsupported
IR Extension	Supported
RS-232 Extension	Supported
USB 2.0 Extension	Supported

HDBaseT Feature Set	Receiver
Video & Audio Extension	Supported
LAN Extension	Unsupported
Send power to Transmitter	Unsupported
Accept power from Transmitter	Supported (PoH)
IR Extension	Supported
RS-232 Extension	Supported
USB 2.0 Extension	Supported

9. ACRONYMS

ACRONYM	COMPLETE TERM
Cat.5e	Enhanced Category 5 cable
Cat.6	Category 6 cable
Cat.6A	Augmented Category 6 cable
Cat.7	Category 7 cable
CEC	Consumer Electronics Control
dB	Decibel
DVI	Digital Visual Interface
Gbps	Gigabits per second
HDBT	HDBaseT
HDCP	High-bandwidth Digital Content Protection
HDMI	High-Definition Multimedia Interface
HDR	High Dynamic Range
IP	Internet Protocol
IR	Infrared
kHz	Kilohertz
KVM	Keyboard/Video/Mouse
LAN	Local Area Network
LED	Light-Emitting Diode
LPCM	Linear Pulse-Code Modulation
MHz	Megahertz
PD	Powered Device
PoH	Power over HDBaseT
PSE	Power Sourcing Equipment
SNR	Signal-to-Noise Ratio
TCP	Transmission Control Protocol
THD+N	Total Harmonic Distortion plus Noise

ACRONYM	COMPLETE TERM
TMDS	Transition-Minimized Differential Signaling
4K UHD	4K Ultra-High-Definition (10.2Gbps max)
4K UHD⁺	4K Ultra-High-Definition (18Gbps max)
USB	Universal Serial Bus
VGA	Video Graphics Array
WUXGA (RB)	Widescreen Ultra Extended Graphics Array (Reduced Blanking)
XGA	Extended Graphics Array
Ω	Ohm



CYPRESS TECHNOLOGY CO., LTD.
www.cypress.com.tw
