



CMPRO-UA8H8HS

8×8 HDMI 4K UHD Matrix
with HDCP 2.2



4K2K

HDCP2.2

Operation Manual



DISCLAIMERS

The information in this manual has been carefully checked and is believed to be accurate. Cypress Technology assumes no responsibility for any infringements of patents or other rights of third parties which may result from its use.

Cypress Technology assumes no responsibility for any inaccuracies that may be contained in this document. Cypress also makes no commitment to update or to keep current the information contained in this document.

Cypress Technology reserves the right to make improvements to this document and/or product at any time and without notice.

COPYRIGHT NOTICE

No part of this document may be reproduced, transmitted, transcribed, stored in a retrieval system, or any of its part translated into any language or computer file, in any form or by any means—electronic, mechanical, magnetic, optical, chemical, manual, or otherwise—without express written permission and consent from Cypress Technology.

© Copyright 2011 by Cypress Technology.

All Rights Reserved.

Version 1.1 August 2011

TRADEMARK ACKNOWLEDGMENTS

All products or service names mentioned in this document may be trademarks of the companies with which they are associated.



SAFETY PRECAUTIONS

Please read all instructions before attempting to unpack, install or operate this equipment and before connecting the power supply.

Please keep the following in mind as you unpack and install this equipment:

- Always follow basic safety precautions to reduce the risk of fire, electrical shock and injury to persons.
- To prevent fire or shock hazard, do not expose the unit to rain, moisture or install this product near water.
- Never spill liquid of any kind on or into this product.
- Never push an object of any kind into this product through any openings or empty slots in the unit, as you may damage parts inside the unit.
- Do not attach the power supply cabling to building surfaces.
- Use only the supplied power supply unit (PSU). Do not use the PSU if it is damaged.
- Do not allow anything to rest on the power cabling or allow any weight to be placed upon it or any person walk on it.
- To protect the unit from overheating, do not block any vents or openings in the unit housing that provide ventilation and allow for sufficient space for air to circulate around the unit.

REVISION HISTORY

VERSION NO.	DATE (DD/MM/YY)	SUMMARY OF CHANGE
RDV1	22/06/15	Preliminary release
RDV2	07/04/17	Corrections to section 6.9



CONTENTS

1. Introduction	1
2. Applications	1
3. Package Contents	1
4. System Requirements	1
5. Features	2
6. Operation Controls and Functions	3
6.1 Front Panel	3
6.2 Rear Panel.....	4
6.3 Side Panel	5
6.4 Remote Control.....	5
6.5 IR Cable Pin Assignment.....	6
6.6 RS-232 Protocol.....	6
6.7 RS-232 and Telnet Commands	7
6.8 Telnet Control	8
6.9 WebGUI Control	10
7. Connection Diagram	13
8. Specifications	14
8.1 Technical Specifications	14
8.2 Supported Resolutions	15
9. Acronyms	16



1. INTRODUCTION

The 8 by 8 HDMI 4K2K Matrix supports the transmission of video (resolutions up to 4K2K Full HD & HDCP 2.2), multi-channel digital audio and control via IR, RS-232, Telnet or WebGUI from eight high definition sources to eight outputs.

It supports high resolution digital audio formats such as LPCM 7.1CH, Dolby TrueHD, Dolby Digital Plus, Dolby Atmos and DTS-HD Master Audio as well as 3D content that can be displayed when connecting a 3D TV and 3D source.

2. APPLICATIONS

- HDMI Matrix System
- Video/TV wall display and control
- Security surveillance and control
- Commercial advertising, display and control
- University lecture hall, display and control
- Retail sales and demonstration

3. PACKAGE CONTENTS

- 1×8 by 8 HDMI 4K UHD Matrix
- 1×IR Extender
- 1×24V/6.25A DC Power Adaptor
- 1×Remote control with battery
- 1×Power Cord
- 1×Ear rack
- 1×Operation Manual

4. SYSTEM REQUIREMENTS

- HDMI equipped source devices, connect with HDMI cables or DVI equipped source, connect with DVI to HDMI cables
- HDMI equipped displays (TVs or monitors) or HDMI equipped AV receivers, connect with HDMI cables



5. FEATURES

- HDMI with 4K2K supported, HDCP 2.2 and DVI compliant
- Supports PC resolution up to WUXGA and HDTV resolution up to 4K2K(3840x2160@24/25/30 & 3840x2160@50/60_YUV420, 4096x2160 @24/25/30 & 4096x2160 @50/60Hz_YUV420)
- Supports 3D signal bypass
- Supports pass-through audio LPCM 2/5.1/7.1CH, Dolby Digital 2~5.1CH, DTS 2~5.1CH, Dolby TrueHD and DTS-HD Master Audio
- Supports IR Extension
- Supports RS-232, remote control, on-panel control and IP control (Telnet & WebGUI)
- 2U size design
- Compliant with DVI source

6. OPERATION CONTROLS AND FUNCTIONS

6.1 Front Panel

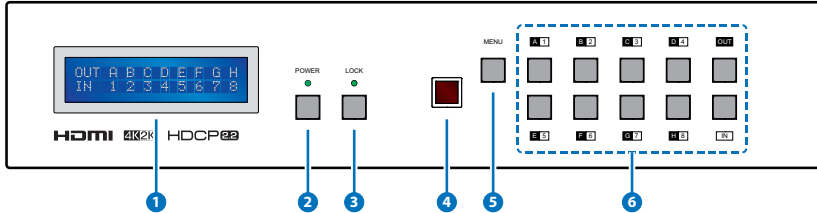

- 1 **LCM:** Displays the setting information of each input and output setting.
- 2 **POWER:** Press this button to power the device on/standby. The LED will illuminate green when the power is on, red when it is in 'Standby' mode.
- 3 **LOCK:** Press this button to lock all the buttons on the panel; press again to unlock. The LED will illuminate orange when locked.
- 4 **IR:** IR Receiver window (accepts the remote control signal of this device only).
- 5 **MENU:** Press this button to access the LCM menu system, from here EDID settings can be managed and IP system settings are displayed.
- 6 **1~8/A~H and OUT/IN:** Press the OUT button and then the number buttons to select the required output ports, and press IN button and then a single number button to select the required input source, finally press the MENU button to confirm the selection.

For example, if outputs A~D need to be set to input 1 and outputs E~H need to be set to input 2 then the following sequence of button presses need to be performed:

Press: OUT→A→B→C→D→IN→1→MENU,

and then press: OUT→E→F→G→H→IN→2→MENU.

Note: If the MENU button is not pressed the selection will not be changed.

6.2 Rear Panel

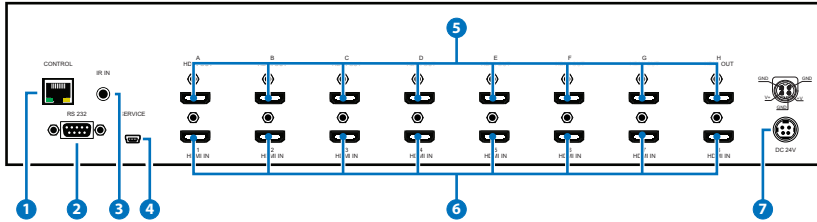

- 1 CONTROL:** This port is the link for Telnet and WebGUI controls, connect to an active Ethernet link with an RJ45 terminated cable (for further details, please refer to section 6.8 & 6.9).

Warning: Please do not connect this port directly to the PC/Laptop as the Telnet function will not work.

- 2 RS-232:** Connect to a PC or control system with D-sub 9-pin cable for the transmission of RS-232 commands.
- 3 IR IN:** Connect to the supplied IR extenders for IR signal reception from the remote control of the Matrix. Ensure that the remote is within the direct line-of-sight of the IR extender when used.
- 4 SERVICE:** Manufacturer use only.
- 5 HDMI OUT A~H:** Connect to HDMI equipped TVs or monitors for display of the HDMI input source signal.
- 6 HDMI IN 1~8:** Connect to the HDMI input source devices such as a DVD player or a Set-top Box with HDMI cable or DVI to HDMI cable..
- 7 DC 24V:** Plug the 24 V DC power supply into the unit and connect the adaptor to an AC outlet.

6.3 Side Panel

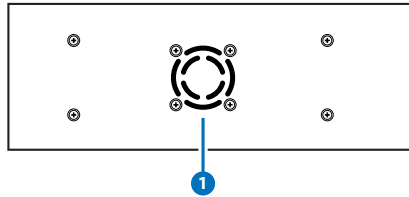

- 1 **Fan Ventilator:** These are air ventilation areas, DO NOT block these areas or cover it with any object. Please allow adequate space around the unit for air circulation.

6.4 Remote Control

- 1 **POWER:** Press this button to switch on the device or set it to standby mode.
- 2 **IN:** Input ports selection 1~8.
- 3 **OUT:** Output ports selection A~H.

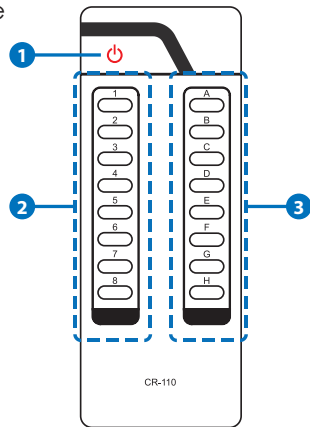

6.5 IR Cable Pin Assignment

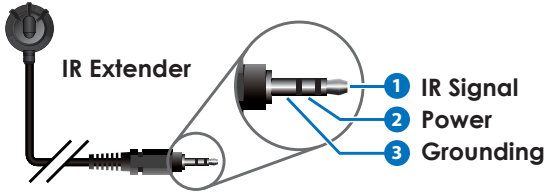

6.6 RS-232 Protocol

MATRIX	
Pin	Assignment
1	NC
2	Tx
3	Rx
4	NC
5	GND
6	NC
7	NC
8	NC
9	NC



REMOTE CONTROLLER	
Pin	Assignment
1	NC
2	Rx
3	Tx
4	NC
5	GND
6	NC
7	NC
8	NC
9	NC

Baud Rate: 115200bps

Data bit: 8 bits

Parity: None

Flow Control: None

Stop Bit: 1

6.7 RS-232 and Telnet Commands

COMMAND	DESCRIPTION	PARAMETER
AN	Switch output A to input N.	N=1~8
BN	Switch output B to input N.	N=1~8
CN	Switch output C to input N.	N=1~8
DN	Switch output D to input N.	N=1~8
EN	Switch output E to input N.	N=1~8
FN	Switch output F to input N.	N=1~8
GN	Switch output G to input N.	N=1~8
HN	Switch output H to input N.	N=1~8
IN	Switch all outputs to input N.	N=1~8
AB.....N	Switch output AB... to input N.	N=1~8
SETIP <x.x.x.x><x.x.x.x><x.x.x.x>	Set IP, SubNet and Gateway (Static IP)	X=0~255
IPCONFIG	Display the current IP configuration	None
RSTIP	Set IP configuration to DHCP	None
P0	Power off	None
P1	Power on	None
STOREN	Store current I/O to position N	N=1~8
SHOWN	Show current port N I/O position	N=1~8
PRESETN	Preset the store I/O position N	N=1~8
NameN N1	Name port N as N1	N=1~8, N1=A~H (Max Length=8)
ST	Show unit firmware version	None
EMN	Setting EDID mode N	N=1 (Standard)/2 (TV)
RS	Routing reset to default	None
USBISP	Update firmware via USB	None
HELP(?)	Display all available commands	None
QUIT	Quit Telnet	None

Note: Any commands will not be executed unless followed by a carriage return. Commands are case-insensitive.

6.8 Telnet Control

Before attempting to use the Telnet control, please ensure that both the Matrix (via the 'LAN /CONTROL' port) and the PC/Laptop are connected to the same active networks.

To access the Telnet control in Windows 7, click on the 'Start' menu and type "cmd" in the Search field then press enter.

Under Mac OS X, go to Go→Applications→Utilities→Terminal

See below for reference.

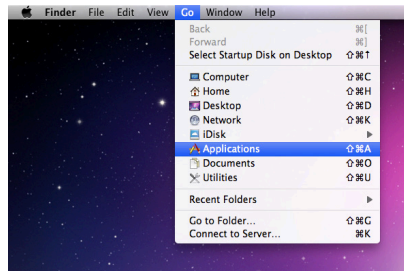
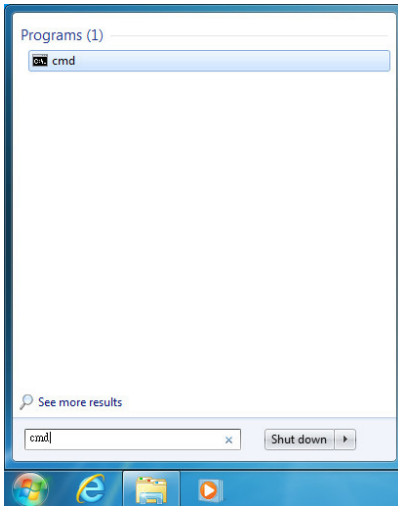

Once in the command line interface (CLI) type "telnet", then the IP address of the unit and "23", then hit enter.

```
Microsoft Windows [Version 6.1.7601]
Copyright (c) 2009 Microsoft Corporation. All rights reserved.

C:\Users\Administrator>telnet 192.168.5.175
```

This will bring us into the unit which we wish to control. Type "help" to list the available commands.

```

Welcome to TELNET.
>?
SETIP      : SET ETHERNET IP ADDRESS
IPCONFIG   : DISPLAY THE CURRENT IPCONFIG
RSTIP     : IP CONFIGURATION RESET TO <DHCP>
P0        : POWER OFF
P1        : POWER ON
STORE     : STORE current I/O position <01~08>
SHOW     : SHOW current port's I/O position <01~08>
PRESET   : PRESET the store I/O position <01~08>
NAME     : NAME N1 N2
the stored port N1<01~08> no more than 8 charactors N2<ABCDEFGH>
I1~I8    : SET ALL OUTPUTS SOURCE
ST       : SHOW UNIT FIRMWARE VERSION
RS      : System Reset to
EM      : Setting EDID MODE. 1-STD 2-TU 3-USER.
USBISP  : Update FW by USB
A1~A8   : SET OUTPUT A SOURCE(1-8)
B1~B8   : SET OUTPUT B SOURCE(1-8)
C1~C8   : SET OUTPUT C SOURCE(1-8)
D1~D8   : SET OUTPUT D SOURCE(1-8)
E1~E8   : SET OUTPUT E SOURCE(1-8)
F1~F8   : SET OUTPUT F SOURCE(1-8)
G1~G8   : SET OUTPUT G SOURCE(1-8)
H1~H8   : SET OUTPUT H SOURCE(1-8)
AB..1~AB..8 : Switch output ABCD... to 1~8 at the same time
UARTSW?  : Display the uart switching state
UARTBAUD? : Display all the output's uart baud
UARTSW   : Switch output's uart to A~H
UARTSW0  : Switch output's uart to MCU
UARTBAUD : Setting outputA~H's uart baud <1:9600bps,2:14400bps,3:19200bps,4:3
8400bps,5:57600bps,6:115200bps>
?        : SHOW DESCRIPT OF COMMAND
QUIT    : Telnet QUIT

```

Note: Commands will not be executed unless followed by a carriage return. Commands are case-insensitive. If the IP is changed then the IP Address required for Telnet access will also change accordingly.

6.9 WebGUI Control

On a PC/Laptop which is connected to an active network system, open a web browser and type device's IP address (available from LCM monitor or OSD menu) on the web address entry bar. The browser will display the device's Switch, Data Routing, EDID Settings and System Settings.

Click 'Switch' page to switch Input and output setting.

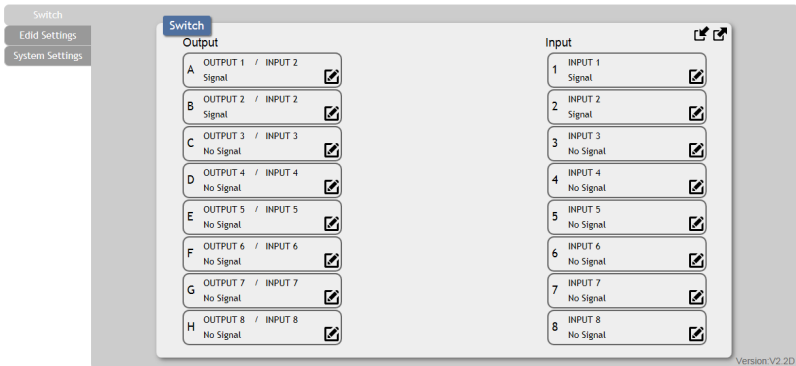

Click on 'EDID Settings' page to Setting EDID mode or update EDID.

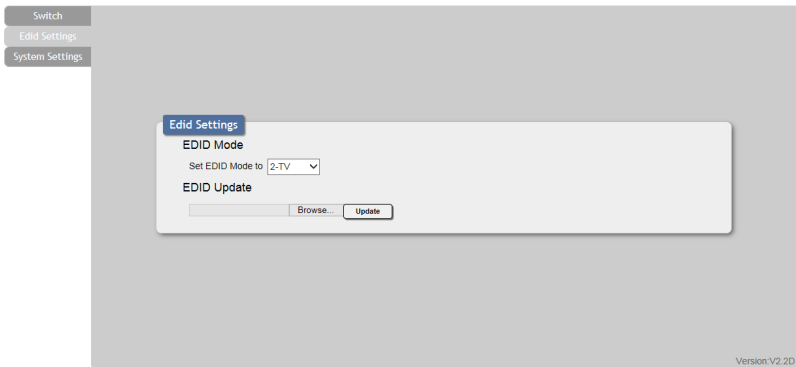

Click on 'System Settings' to control power on / off, Network status setting and reset to default settings.

Note: It will need to click on save button once you finished network parameters setting.

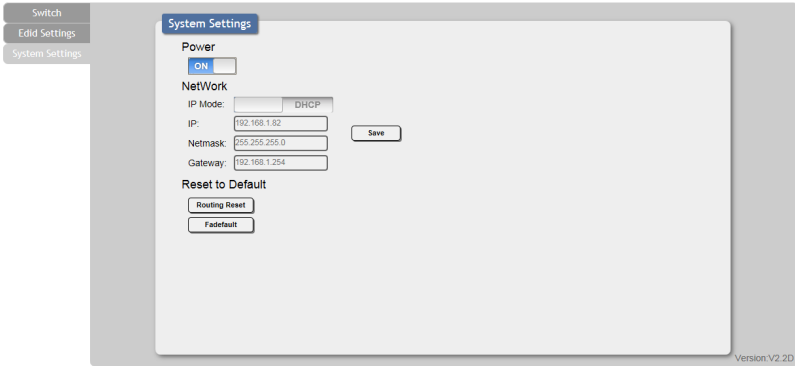

7. CONNECTION DIAGRAM

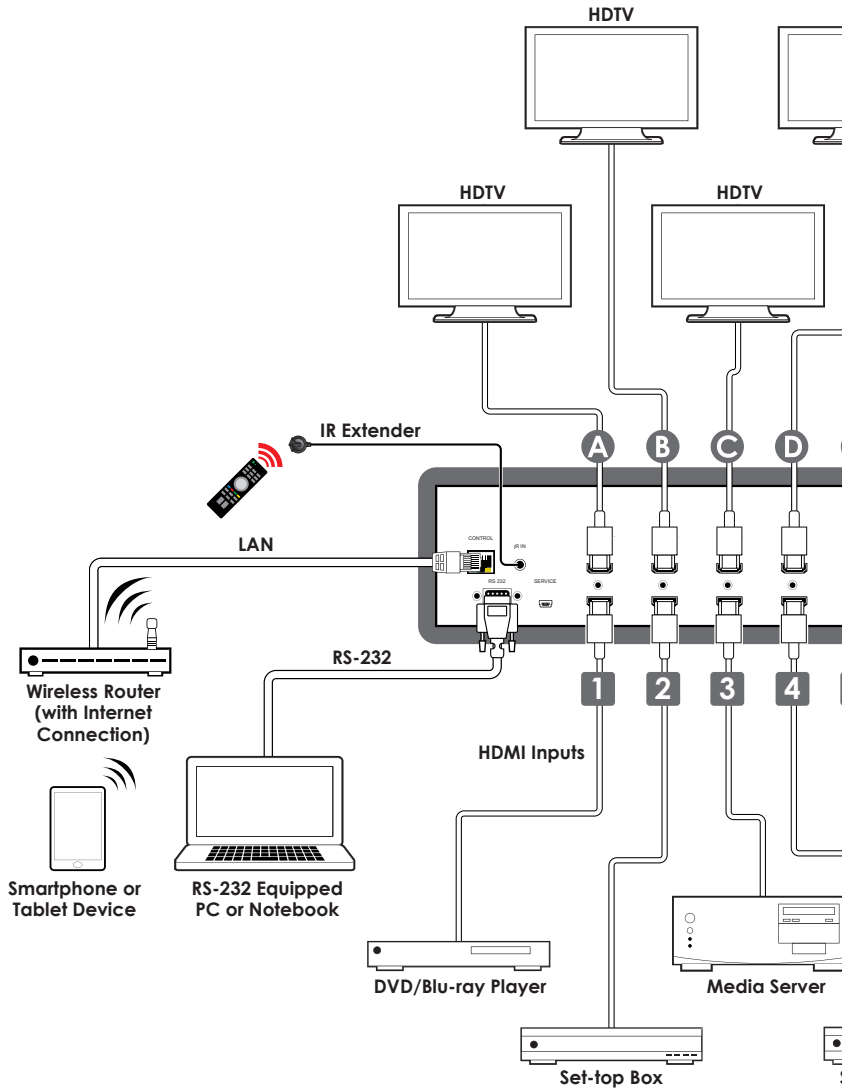

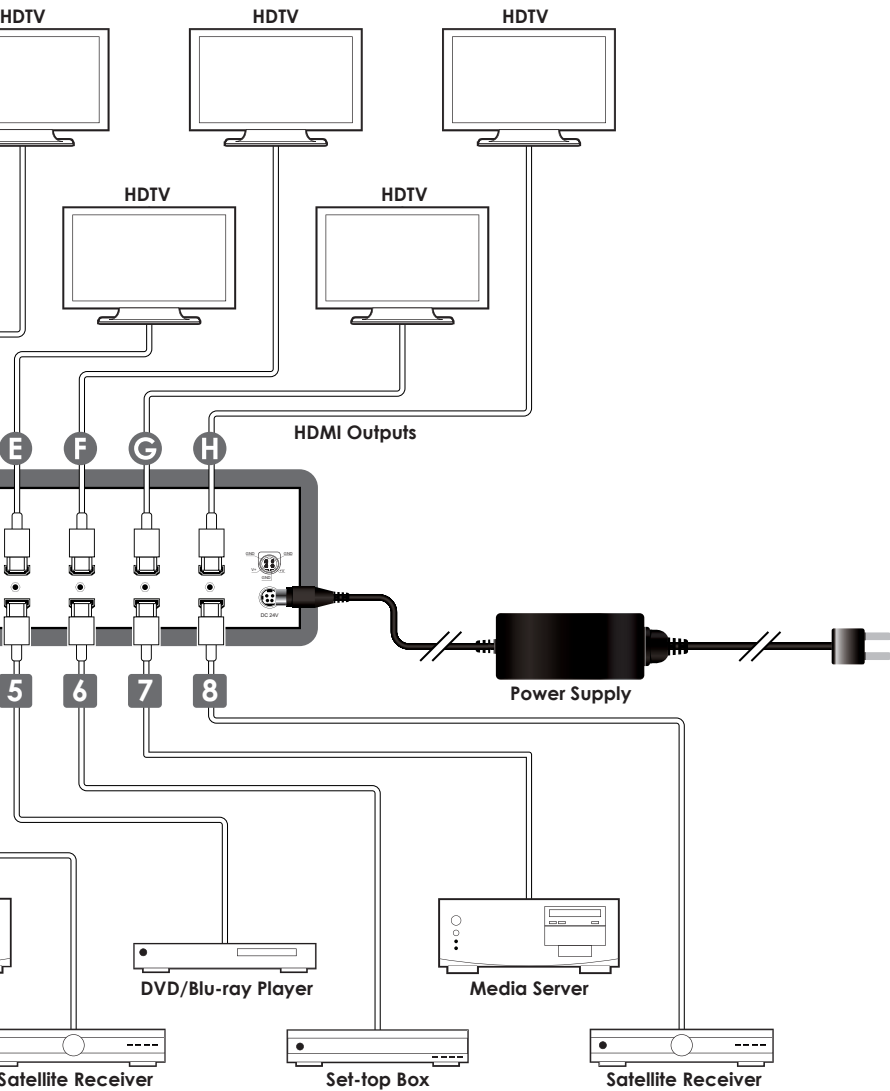



8. SPECIFICATIONS

8.1 Technical Specifications

Video Bandwidth	300 MHz/9 Gbps
Input Ports	8×HDMI, 1×IR (3.5mm), 1×RS-232 (9-pin D-sub), 1×Control (RJ-45), 1×USB (Service only)
Video Resolutions	480i~1080p@24/50/60, 4K@24/25/30, 4K@50/60 (YUV420) & VGA~WUXGA
IR Frequency	30~50 kHz
Baud Rate	115200 bps
Output Ports	8×HDMI
Power Supply	24 V/6.25 A DC (US/EU standards, CE/FCC/UL certified)
ESD Protection	Human body model: ±8 kV (air-gap discharge) ±6 kV (contact discharge)
Dimensions	438 mm (W)×249 mm (D)×88 mm (H)/ Jack Excluded 438 mm (W)×256.7 mm (D)×92 mm (H)/ Jack Included
Weight	4592 g
Chassis Material	Metal
Color	Black
Operating Temperature	0°C~40°C/32°F~104°F
Storage Temperature	-20°C~60°C/-4°F~140°F
Relative Humidity	20~90% RH (non-condensing)
Power Consumption	35 W

8.2 Supported Resolutions

Resolution	Input	Output
640×480@60	√	√
720×480p@60	√	√
720×576p@50	√	√
800×600@60	√	√
1024×768@60	√	√
1280×720p@50	√	√
1280×720p@60	√	√
1280×1024@60	√	√
1600×1200@60	√	√
1920×1080i@50	√	√
1920×1080i@60	√	√
1920×1080p@24	√	√
1920×1080p@24FP	√	√
1920×1080p@25	√	√
1920×1080p@30	√	√
1920×1080p@50	√	-
1920×1080p@60	√	√
1920×1200@60 (RB)	√	√
3840×2160@24	√	√
3840×2160@25	√	√
3840×2160@30	√	√
3840×2160@50 (YUV420)	√	√
3840×2160@60 (YUV420)	√	√
4096×2160@24	√	√
4096×2160@50 (YUV420)	√	√
4096×2160@60 (YUV420)	√	√

9. ACRONYMS

ACRONYM	COMPLETE TERM
CLI	Command Line Interface
DTS	Digital Theater System
DVI	Digital Visual Interface
GUI	Graphical User Interface
HDCP	High-bandwidth Digital Content Protection
HDMI	High-Definition Multimedia Interface
HDTV	High-Definition Television
IR	Infrared
LCM	Liquid Crystal Module
USB	Universal Serial Bus
VGA	Video Graphics Array
WUXGA (RB)	Widescreen Ultra Extended Graphics Array (Reduce Blanking)



CYPRESS TECHNOLOGY CO., LTD

Home page: <http://www.cypress.com.tw>