

A45

2MP Zoom Bullet with D/N, Adaptive IR, Extreme WDR, ELLS, 4.3x Zoom Lens



- 2 Megapixel
- Day & Night with Extreme Low Light Sensitivity and Adaptive IR LED
- 4.3x Zoom Lens with f2.8-12/F1.4-F2.8, Auto focus (for installation)
- Extreme WDR
- H.265 Compression
- Wide Angle
- Event trigger, response and notification

► Specifications

Device

Product Type	Zoom Bullet
Maximum Resolution	2MP
Application Environment	Outdoor
Image Sensor	Progressive Scan CMOS
Sensor Size	1/2.8 "
Effective Pixels	1945(H) X 1097(V) (2.13 MP)
Day / Night	Yes
Low Light Sensitivity	Extreme
Minimum Illumination	Color: 0.05 lux at F1.4; B/W 0.005 lux at F1.4 (AGC on)
Color to B/W Switch	ISP based switch, configurable
Mechanical IR Cut Filter	Yes
IR Sensitivity Range	700-1150nm
IR LED	Adaptive IR LED
IR Working Distance	30m
Electronic Shutter	1/5-1/64000 second (manual mode); 1/5-1/64000 second (auto mode)

Horizontal Resolution (TV Lines) | 1000 TVL

Lens

Focal Length	Zoom, f2.8-12mm
Aperture	F1.4-F2.8
Zoom Ratio	4.3x optical zoom
Zoom Application	Camera Installation
Iris	Adaptive iris
Focus	Auto focus
Lens Mount	Board mount
Horizontal Viewing Angle	92° - 34.8°
Vertical Viewing Angle	49.3° - 19.8°

Video

Compression	H.265, H.264 (Main profile), MJPEG
Maximum Frame Rate vs. Resolution	60 fps at 1920 x 1080 30 fps at 1280 x 960 60 fps at 1280 x 720 30 fps at 800 x 600 30 fps at 720 x 480 30 fps at 640 x 480 30 fps at 320 x 240
High Frame Mode	Support
Multi-Streaming	Simultaneous triple streams based on three configurations
Bit Rate Mode	Constant, Variable
Wide Dynamic Range	Extreme WDR (142 dB)
Image Enhancement	White Balance, Brightness, Backlight compensation (BLC), Contrast, Saturation, Sharpness, Automatic gain control, Flickerless, Digital Image Stabilizer (DIS, EIS), Defogging
Digital Noise Reduction	2D + 3D DNR
Privacy Mask	4 configurable regions
Text Overlay	Yes
On-Screen Graphics	Yes
Built-in Analytics	Tampering Detection
Server-based Analytics	Object Line Counting, People Counting, Face Detection, Object Based Motion Detection, Tamper, Object Line Crossing Detection, Object Enter Area Detection, Missing Object Detection, Unattended Object Detection, Smoke Detection, Heat Map, Dwell Time, Direction Detection, Automatic License Plate Recognition, People Queue Detection, (Require PC-based or standalone IVS or ALPR Server. Contact ACTi support for recommendations on how to maximize analytical accuracy)
Image Orientation	Flip, Mirror, Rotation (Corridor mode)

Audio

Audio Type	2-way, Mic-in, Line-in, Line-out
Audio Compression	8 kHz, Mono, G.711

Network

Network Protocol & Service	IPv4/v6, TCP, UDP, DHCP, PPPoE, HTTP, HTTPS, DNS, DDNS, NTP, RTP, RTSP, RTCP, SMTP, FTP, IGMP, ICMP, ARP, Bonjour, UPnP, QoS, SNMP, IEEE 802.1X
----------------------------	---

Ethernet Port	1 x Ethernet (10/100 Base-T), RJ-45 pigtail connector
Security	IP address filtering, HTTPS encryption, Password protected user level, Anonymous login

Video Analytics

Analysis Source Type	Video
----------------------	-------

Event

Event Trigger	Video motion detection (3 regions), External device through digital input, Sound detection, Tampering detection, Video streams loss
Event Response	Notify control center, Change camera settings, Command other devices, E-mail notification with snapshots, Play the audio file, Push notification to mobile device, Save video to local storage, Upload video to NVR server, Upload video or snapshot to FTP server, Activate external device through digital output

System

Watchdog	Support
----------	---------

Integration

Unified Solution	Fully compatible with ACTi software
ONVIF Compliant	Yes, Profile S, Profile G, Profile T, Profile Q
Web Browser	IE 11
Auto Firmware Upgrade	Yes

Interface

Audio Interface	Cable with 3.5mm Phone Jack
Local Storage	MicroSDHC, MicroSDXC Memory Card Slot (card not included, up to 256GB, Kingston or Sandisk only)
Digital Input/Output	1/1 (Cable with Terminal block), DC Output Voltage: 5V
Operating Button	Reset Button

General

Power Source	DC 12V, PoE Class 3 (IEEE802.3af)
Power Consumption	12.95 W (PoE)
Weight	1240g (2.73lb)
Dimensions	(W x H x D): 94mm x 86mm x 291.1mm (3.7" x 3.38" x 11.46")
Environmental Casing	Weatherproof (IP66), Vandal proof metal casing (IK10)
Bundled Accessories	Integrated bracket
Mount Type	Integrated Bracket, Wall Mount, Ceiling Bracket, Pole Mount
Starting Temperature	-20°C ~ 50°C (-4°F ~ 122°F)
Operating Temperature	-30°C ~ 50°C (-22°F ~ 122°F)
Operating Humidity	20% - 80% RH
Approvals	CE, FCC, EAC, IP66, IK10 (metal casing)
Real-time Clock (RTC)	Yes
Warranty	3 Year(s). For extended warranty offering, see http://www.acti.com/support/warranty

► Photo Indication



- ① Audio Output
- ② DC 12V Power Input
- ③ Factory Reset
- ④ Audio Input
- ⑤ Ethernet Port
- ⑥ Digital Input / Output

► Dimension Diagram

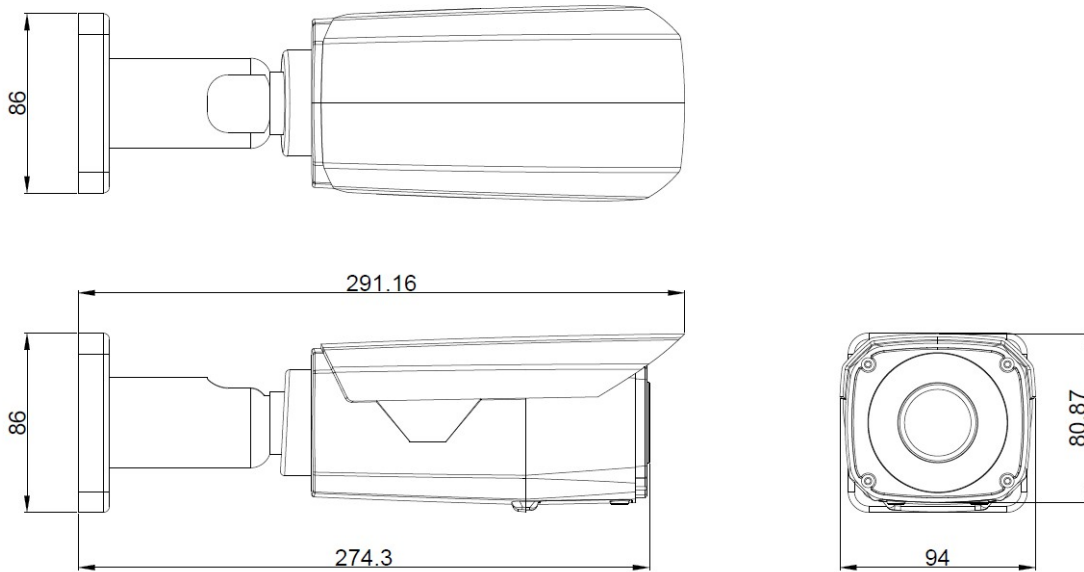

Unit: mm [inch]

▶ Related Products

Bullet - Bullet



E43B		5MP Bullet with D/N, Adaptive IR, Basic WDR, Vari-focal lens, f2.8-12mm/F1.4 (HOV:69.2°-28.2°), H.264, 1080p/30fps, DNR, Audio, MicroSDHC/MicroSDXC, PoE, IP68, IK10 (metal casing), DI/DO
------	---	--

Mounting Accessories - Camera Mount

PMAX-0517		Pole Mount (for A44, A45, A46, A48, A413), supports 3.25" to 7.0" Poles
PMAX-0518		Pole Mount (for A44, A45, A46, A48, A413), supports 2" to 3" Poles
PMAX-0524		Pole Mount (for A416, A418, ,A419, A44, A45, A46, A48, VMGB-351, B419-P2), supports 2.64" to 5" Poles
PMAX-0706		Junction Box (for A3x, A4x, E39, E41x, PMAX-0805)

Note: Some mounting accessories may need additional accessories for installation. Please check www.acti.com/mountingselector for more information.



Power Supply Accessories - Power Adapter

PPBX-0012		Power Adapter AC 100~240V (US), for A3x, A4x, A88, A9x, Z31, Z8x, Z9x
PPBX-0013		Power Adapter AC 100~240V (EU), for A3x, A4x, A88, A9x, Z31, Z8x, Z9x
PPBX-0014		Power Adapter AC 100~240V (UK), for A3x, A4x, A88, A9x, Z31, Z8x, Z9x

Power Supply Accessories - PoE Injector

PPOE-0002		PoE Injector IEEE 802.3af compliant, AC 100~240V, with universal connectors
-----------	---	---

Audio Devices - Microphone

PMIC-0100		Active Microphone Omnidirectional for all Cameras with Line-in Audio
PMIC-0200		Passive Microphone Omnidirectional for all Cameras with Mic-in Audio using 3.5mm Phone Jack