

A818

6MP Outdoor Zoom Dome with D/N, IR, Extreme WDR, SLLS, 5x Zoom Lens



- 6 Megapixel
- Day & Night with Superior Low Light Sensitivity and IR LED
- Extreme WDR
- Wide Angle
- Taiwan IoT Cybersecurity Certification Level 1 (TAICS, TCA)
- Event trigger, response and notification

► Specifications

Device

Product Type	Zoom Dome
Maximum Resolution	6MP
Application Environment	Outdoor
Image Sensor	Progressive Scan CMOS
Sensor Size	1/2.7 "
Day / Night	Yes
Low Light Sensitivity	Superior
Minimum Illumination	Color: 0.01 lux; B/W: 0 lux (IR LED on)
Color to B/W Switch	ISP based switch, configurable
Mechanical IR Cut Filter	Yes
IR LED	IR LED x 2 (850 nm)
IR Working Distance	85m (1.0 lux)
Electronic Shutter	1/30-1/100000 second (auto mode)
S/N Ratio	75 dB

Lens

Focal Length	Zoom, f2.7-13.5mm
Aperture	F1.6
Zoom Ratio	5x optical zoom
Zoom Application	Camera Installation
Focus	Auto focus
Lens Mount	Board mount
Horizontal Viewing Angle	82.2° - 28.7°
Vertical Viewing Angle	54.5° - 19°
Viewing Angle Adjustment	Pan: 0°-355°, Tilt: 0°-75°, Rotation: 0°-355°

Video

Compression	H.265 Adaptive Stream (equivalent to Zip or Smart Stream or H.265+), H.264 Adaptive Stream (equivalent to Zip or Smart Stream or H.264+), MJPEG
Maximum Frame Rate vs. Resolution	20 fps at 3072 x 2048 20 fps at 2592 x 1944 25 fps at 2688 x 1520 30 fps at 2560 x 1440 30 fps at 1920 x 1080 30 fps at 1280 x 960 30 fps at 1280 x 720 30 fps at 640 x 480
Multi-Streaming	Simultaneous quad streams
Bit Rate	128Kbps - 12Mbps (per stream)
Bit Rate Mode	Constant, Variable
Wide Dynamic Range	Extreme WDR (150 dB)
Image Enhancement	White Balance, Backlight compensation (BLC), Brightness, Contrast, Sharpness, Automatic gain control
Digital Noise Reduction	2D + 3D DNR
Privacy Mask	4 configurable regions
Text Overlay	Yes
Built-in Analytics	Tampering Detection, Face Detection, Object Line Crossing Detection, Object Enter Area Detection
Server-based Analytics	Object Line Counting, People Counting, Face Detection, Object Based Motion Detection, Tamper, Object Line Crossing Detection, Object Enter Area Detection, Missing Object Detection, Unattended Object Detection, Smoke Detection, Heat Map, Dwell Time, Direction Detection, Automatic License Plate Recognition, People Queue Detection, (Require PC-based or standalone IVS or ALPR Server. Contact ACTi support for recommendations on how to maximize analytical accuracy)
Image Orientation	Flip, Mirror, Rotation (Corridor mode)

Audio

Audio Type	2-way, Mic-in, Line-in, Line-out
Audio Compression	G.711

Network

Network Protocol & Service	IPv4/v6, TCP, UDP, DHCP, PPPoE, HTTP, HTTPS, DNS, DDNS, NTP, RTP, RTSP, RTCP, SMTP, FTP, SFTP, IGMP, ICMP, Bonjour, UPnP, QoS, SNMP, IEEE 802.1X
Ethernet Port	1 x Ethernet (10/100 Base-T), RJ-45 pigtail connector

Security	IP address filtering, HTTPS encryption, Password protected user level, Anonymous login, IEEE 802.1X network access control, Standard IoT Security (anti-hacking, anti-malware)
----------	--

Event

Event Trigger	Video motion detection (10 included and excluded polygonal regions), External device through digital input, Intelligent event detection, Sound detection, Video streams loss, System log buffer overrun, Remove system log, Logon events (Login Failure, Login Success, Block an Account)
Event Response	Notify control center, Change camera settings, Command other devices, E-mail notification with snapshots, Play the audio file, Push notification to mobile device, Save video to local storage, Upload video to NVR server, Upload video or snapshot to FTP server, Activate external device through digital output

System

System Monitor	CPU loading, memory usage and network statistics via API
System Log	Support
Watchdog	Support

Integration

Unified Solution	Fully compatible with ACTi software
GPS Position	Manual setting
Edge Recording	Support (integration with NVR by ONVIF Profile G or proprietary protocol)**
ONVIF Compliant	Yes, Profile S, Profile G, Profile T, Profile M
GB28181 Compliant	Yes
Web Browser	IE 11, Google Chrome*, Microsoft Edge*, Apple Safari*
Auto Firmware Upgrade	Yes

Interface

Audio Interface	Terminal block
Analog Video Output	1 x CVBS, BNC connector, for installation only
Local Storage	MicroSD, MicroSDHC, MicroSDXC Memory Card Slot (card not included, up to 256GB, Kingston or Sandisk only)
Digital Input/Output	1/1 (Terminal block)
Operating Button	Reset Button

General

Power Source	DC 12V, PoE Class 3 (IEEE802.3af)
Power Consumption	12 W (PoE), 10 W (DC)
Weight	1046g (2.306lb)
Dimensions	(Ø x H): 141mm x 99.5mm (5.55" x 3.9")
Environmental Casing	Weatherproof (IP68), Vandal proof (IK10)
Corrosion Protection	Optional for project request. Chassis corrosion resistance at the seashore approximately 2-3 years.
Operating Temperature	-30°C ~ 60°C (-22°F ~ 140°F)
Operating Humidity	10% - 95% RH

Approvals	CE Class B, FCC Class B, EAC, BIS, IP68, NEMA 4X, IK10, Taiwan IoT Cybersecurity Certification Level 1 (TAICS, TCA)
Real-time Clock (RTC)	Yes
Warranty	3 Year(s). For extended warranty offering, see http://www.acti.com/support/warranty

* cross-browser compatibility: Not available for H.265 video decoding ** Edge Recording function is integrated with NVR 3 Corporate / NVR 3 Business / INR / GNR series.

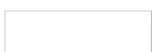

► Photo Indication



- 1 Analog Video Output Connector
- 2 DC 12V Input
- 3 Audio Input / Output
- 4 Digital Input / Output
- 5 Ethernet Port
- 6 Memory Card Slot
- 7 Reset Button



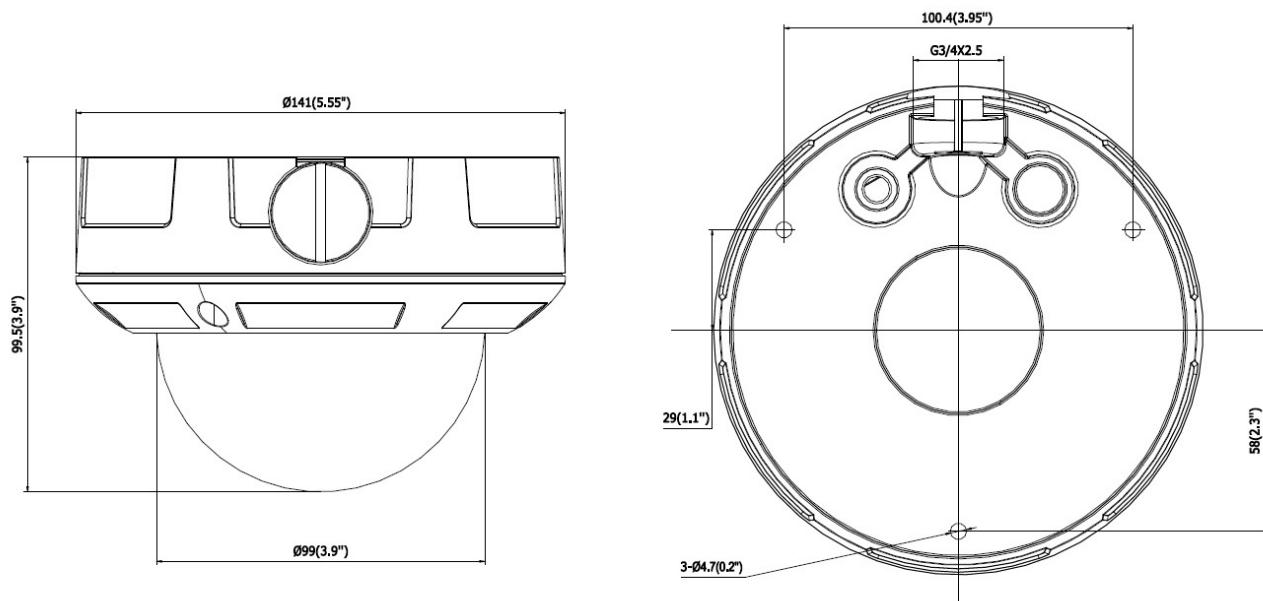













► Dimension Diagram



Unit: mm [inch]

► Related Products

Mounting Accessories - Camera Mount

PMAX-0102		Straight Tube
PMAX-0103		Straight Tube with Bracket
PMAX-0104		Extension Tube
PMAX-0127		Mount Kit (for Z83, Z84, Z810, A811, A818)
PMAX-0302		Gooseneck with Bracket
PMAX-0303		Gooseneck
PMAX-0321		Heavy Duty Wall Mount for Outdoor Domes (for A8x, Z83, Z84, except A88)
PMAX-0402		Corner Mount
PMAX-0503		Pole Mount (for PMA-0102, PMA-0312, PMA-0313, PMA-0314, PMA-0702, PMA-1106, PMA-1107), supports 5.25" to 8.5" Poles
PMAX-0505		Pole Mount (for B4x, B41x, E44, E45, E46, E48, E44A, E45A, E46A, E41x, I4x, PMA-0312, PMA-0313, PMA-0314, PMA-0330), supports 2" to 3" Poles
PMAX-0702		Junction Box for PTZ and Dome Cameras
PMAX-0722		Junction Box (for A811, A813, A818)
PMAX-0807		Gangbox Converter (for PMA-0102, PMA-0312, PMA-0313, PMA-0314, PMA-0321), supports Two-Gang Boxes
PMAX-0808		Converter Ring, 1.5" NPT for Third-Party Mounting Accessories
PMAX-1030		Flush Mount (for A811, A813, A818)
PMAX-1501		Cable Gland for Outdoor Domes (except Hemispheric Domes)

Note: Some mounting accessories may need additional accessories for installation. Please check www.acti.com/mountingselector for more information.

Dome Covers - Transparent Dome Cover

R701-70010		Transparent Dome Cover Only (for A811, A818)
------------	---	--



Power Supply Accessories - Power Adapter

PPBX-0013		Power Adapter AC 100~240V (EU), for A3x, A4x, A88, A9x, Z31, Z8x, Z9x
PPBX-0014		Power Adapter AC 100~240V (UK), for A3x, A4x, A88, A9x, Z31, Z8x, Z9x
PPBX-0026		Power Adapter AC 100~240V (US), for A3x, A4x, A7x, A88, A9x, Z3x, Z4x, Z7x, Z8x, Z9x

Power Supply Accessories - PoE Injector

PPOE-0107		High PoE Injector IEEE 802.3at compliant, AC 100~240V, with universal connectors (for A416, A418, B913, B923, B934, Q450, Q75, VMGB-60X, Z37, Z71, Z952)
-----------	---	--

Audio Devices - Microphone

PMIC-0100		Active Microphone Omnidirectional for all Cameras with Line-in Audio
PMIC-0201		Passive Microphone Omnidirectional for all Cameras with Mic-In Audio using Cable Wire or Terminal Connector, 2m cable