

A950

8MP Outdoor Speed Dome with D/N, Adaptive IR, Extreme WDR, ELLS, 22x Zoom Lens



- 8 Megapixel with 4K Ultra HD
- Day & Night with Extreme Low Light Sensitivity and Adaptive IR LED
- Extreme WDR
- Endless Pan & Tilt

► Specifications

Device

Product Type	Speed Dome
Maximum Resolution	8MP
Application Environment	Outdoor
Image Sensor	Progressive Scan CMOS
Sensor Size	1/1.8 "
Effective Pixels	3864(H) X 2180(V) (8.42 MP)
Day / Night	Yes
Low Light Sensitivity	Extreme
Minimum Illumination	Color: 0.002 lux; B/W: 0 lux (IR LED on)
Mechanical IR Cut Filter	Yes
IR LED	Adaptive IR LED
IR Working Distance	100m
S/N Ratio	75 dB

Lens

Focal Length	Zoom, f6.4-138.5mm
--------------	--------------------

Aperture	F1.5
Zoom Ratio	22x optical zoom
Iris	DC iris
Focus	Auto focus
Lens Mount	Board mount
Horizontal Viewing Angle	59.8° - 3°

PTZ

Manual Panning / Tilting Speed	0.1° - 90°/second, 0.1° - 55°/second
Preset Panning / Tilting Speed	300°/second, 300°/second
Panning Range	360° endless
Tilting Range	-20°~100°
PTZ Control	Remote manual control, Speed Control, Drag to Pan and Tilt, Click to Center, 256 preset points, Auto scan
Absolute Position	Yes

Video

Compression	H.265 Adaptive Stream (equivalent to Zip or Smart Stream or H.265+), H.264, MJPEG
Maximum Frame Rate vs. Resolution	30 fps at 3840 x 2160 (4K Ultra HD) 30 fps at 3200 x 1800 30 fps at 1920 x 1080 30 fps at 1280 x 1024 30 fps at 1280 x 720 30 fps at 800 x 600 30 fps at 720 x 480 30 fps at 640 x 480 30 fps at 352 x 240 30 fps at 320 x 240
Multi-Streaming	Quad streams
Wide Dynamic Range	Extreme WDR (120 dB)
Image Enhancement	Gyro-based Image Stabilizer
Digital Noise Reduction	2D + 3D DNR
Privacy Mask	Yes
Text Overlay	Yes
Built-in Analytics	Object Based Motion Detection
Image Orientation	Flip, Mirror

Network

Ethernet Port	1 x Ethernet (10/100 Base-T), RJ-45 connector Network Cable: all 4 pairs of standard Cat 5e or higher Ethernet cable
---------------	--

Event

Event Trigger	Video motion detection
---------------	------------------------

System

Watchdog	Support
----------	---------

Integration

ONVIF Compliant	Yes, Profile S, Profile G, Profile T
Web Browser	Google Chrome, Firefox

Interface

Local Storage	MicroSD, MicroSDHC, MicroSDXC Memory Card Slot (card not included, up to 256GB, Kingston or Sandisk only, microSD to SD Memory Card Adapter is required.)
Digital Input/Output	4/2
Operating Button	Reset Button

General

Power Source	AC 24V 3A, High PoE 60W
Power Consumption	High PoE: Max. 46.20W (by using all 4 pairs of standard Cat 5e or higher Ethernet cable), AC: Max. 52.80W, 71.50VA
Weight	4155g (9.16lb)
Dimensions	(Ø x H): 207.4mm x 300.4mm (8.17" x 11.83")
Environmental Casing	Weatherproof (IP66)
Corrosion Protection	Optional for project request. Chassis corrosion resistance at the seashore approximately 2-3 years.
Bundled Accessories	High PoE injector
Mount Type	Wall Mount, Ceiling Bracket, Pendant, Corner Mount, Pole Mount, Converter for NPT Standard Mounts
Heater	Yes
Operating Temperature	-40°C ~ 50°C (-40°F ~ 122°F)
Approvals	CE Class A, FCC Class A, IP66
Real-time Clock (RTC)	Yes
Warranty	3 Year(s) (1 year in continuous motion). For extended warranty offering, see http://www.acti.com/support/warranty

► Photo Indication

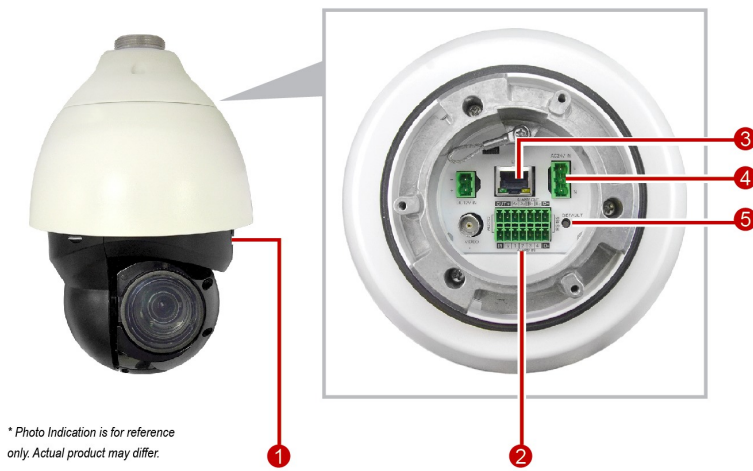

- 1 Memory Card Slot
- 2 Digital Input/Output & Serial Port Connector
- 3 Ethernet Port
- 4 AC24V Power Input
- 5 Reset Button

** Photo Indication is for reference only. Actual product may differ.*



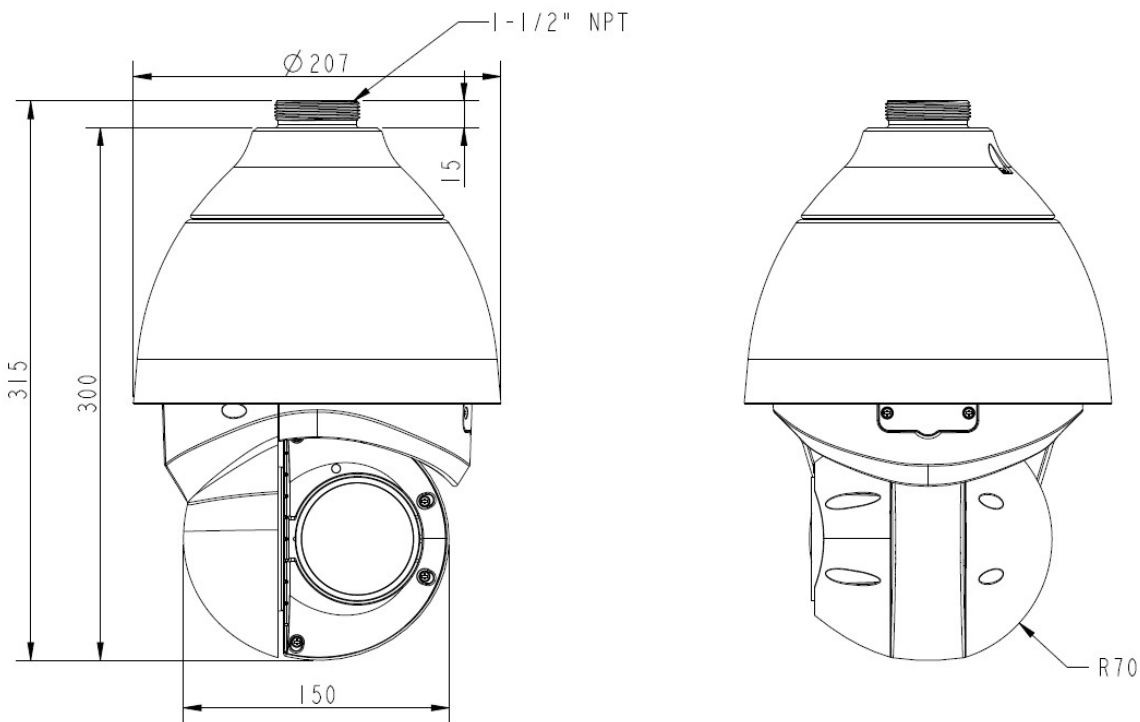





► Dimension Diagram



Unit: mm [inch]



▶ Related Products

Mounting Accessories - Camera Mount

PMAX-0115		Pendant Mount (for A950, A951, A952, A956, Z950, Z952)
PMAX-0119		Pendant Mount (for A950)
PMAX-0343		Gooseneck with Bracket with Converter Ring (for Q75)
PMAX-0344		Gooseneck with Converter Ring (for Q75)
PMAX-0346		Heavy Duty Wall Mount with Converter Ring (for Q75, A950, A951, A952, A956)
PMAX-0402		Corner Mount
PMAX-0514		Pole Mount (for A950)
PMAX-0531		Pole mount for A951

Note: Some mounting accessories may need additional accessories for installation. Please check www.acti.com/mountingselector for more information.

Power Supply Accessories - PoE Injector

PPOE-0103		High PoE Injector, Single-port, 60W Gigabit Midspan, 4-Pairs, 802.3at Compliant, AC 100~240V, with universal connectors (for, I93~I910, I915, B915~B917, B922, B928, B945, B949, A950, A951)
PPOE-0104		High PoE Injector, Single-port, 10/100/1000Mbps 60W, 4-Pairs, 802.3at Compliant, AC 100~240V, with universal connectors (for, I93~I910, I915, B915~B917, B922, B928, B945, B949, A950, A951)