

# B412

## 3MP Zoom Bullet with D/N, Adaptive IR, Extreme WDR, SLLS, 10x Zoom Lens



- 3 Megapixel
- Day & Night with Superior Low Light Sensitivity and Adaptive IR LED
- 10x Zoom Lens with f4.7-47mm/F1.6-F3.0, DC iris, Auto focus
- Extreme WDR
- H.265 Compression
- Event trigger, response and notification

### ► Specifications

#### Device

Product Type	Zoom Bullet
Maximum Resolution	3MP
Application Environment	Outdoor
Image Sensor	Progressive Scan CMOS
Sensor Size	1/2.8 "
Effective Pixels	2065(H) X 1553(V) (3.21 MP)
Day / Night	Yes
Low Light Sensitivity	Superior
Minimum Illumination	Color: 0.003 lux at F1.6; B/W: 0 lux (IR LED on)
Color to B/W Switch	ISP based switch, configurable
Mechanical IR Cut Filter	Yes
IR Sensitivity Range	700-1100nm
IR LED	Adaptive IR LED x 10 (850 nm)
IR Working Distance	60m
Electronic Shutter	1/5-1/64000 second (manual mode); 1/5-1/64000 second (auto mode)

Horizontal Resolution (TV Lines)	1450 TVL
S/N Ratio	56 dB

### Lens

Focal Length	Zoom, f4.7-47mm
Aperture	F1.6-F3.0
Zoom Ratio	10x optical zoom
Zoom Application	Camera Installation, Auto Zoom by Event, Manual Operation
Iris	DC iris
Focus	Auto focus
Lens Mount	Board mount
Horizontal Viewing Angle	58° - 5.8°
Vertical Viewing Angle	45.3° - 5°

### PTZ

Absolute Position	Yes
Pan, Tilt or Zoom protocol	Visca, Pelco-D, Pelco-P, ACTi URL command

### Video

Compression	H.265, H.264 (Baseline/ Main/ High profile), MJPEG
Maximum Frame Rate vs. Resolution	30 fps at 2048 x 1536 30 fps at 1920 x 1080 30 fps at 1280 x 960 30 fps at 1280 x 720 30 fps at 800 x 600 30 fps at 640 x 480 30 fps at 320 x 240
Multi-Streaming	Simultaneous triple streams based on three configurations
Bit Rate	128Kbps - 12Mbps (per stream)
Bit Rate Mode	Constant, Variable
Wide Dynamic Range	Extreme WDR (145 dB)
Image Enhancement	White Balance, Brightness, Contrast, Saturation, Sharpness, Automatic gain control, Flickerless, Defogging
Digital Noise Reduction	2D + 3D DNR
Privacy Mask	4 configurable regions
Text Overlay	Yes
Built-in Analytics	Object Based Motion Detection, Tampering Detection, Shock Detection
Server-based Analytics	Object Line Counting, People Counting, Face Detection, Object Based Motion Detection, Tamper, Object Line Crossing Detection, Object Enter Area Detection, Missing Object Detection, Unattended Object Detection, Smoke Detection, Heat Map, Dwell Time, Direction Detection, Automatic License Plate Recognition, People Queue Detection, (Require PC-based or standalone IVS or ALPR Server. Contact ACTi support for recommendations on how to maximize analytical accuracy)
Image Orientation	Flip, Mirror, Rotation (Corridor mode)

### Audio

Audio Type	2-way, Built-in Microphone, Mic-in, Line-in, Line-out
Audio Compression	8 kHz, 16 bit encoding, Mono, PCM, G.711

**Network**

Network Protocol & Service	IPv4/v6, TCP, UDP, DHCP, PPPoE, HTTP, HTTPS, DNS, DDNS, NTP, RTP, RTSP, RTCP, SMTP, FTP, IGMP, ICMP, ARP, Bonjour, UPnP, QoS, SNMP, IEEE 802.1X
Ethernet Port	1 x RJ-45 pigtail connector
Security	IP address filtering, HTTPS encryption, Password protected user level, Anonymous login, IEEE 802.1X network access control

**Event**

Event Trigger	Video motion detection (10 included and excluded polygons regions), External device through digital input, Tampering detection, Shock Detection, Sound detection, Video streams loss, System log buffer overrun, Remove system log, Logon events (Login Failure, Login Success, Block an Account)
Event Response	Notify control center, Go to Zoom preset point or preset tour, Change camera settings, Command other devices, E-mail notification with snapshots, Push notification to mobile device, Save video to local storage, Upload video or snapshot to FTP server, Upload video or snapshot to FTP server, Activate external device through digital output

**System**

System Log	Support
Watchdog	Support

**Integration**

Unified Solution	Fully compatible with ACTi software
GPS Position	Manual setting
Edge Recording	Support (integration with NVR by ONVIF Profile G or proprietary protocol)**
ONVIF Compliant	Yes, Profile S, Profile G, Profile T
GB28181 Compliant	Yes
Web Browser	IE 11, Google Chrome*, Microsoft Edge*, Apple Safari*
Auto Firmware Upgrade	Yes

**Interface**

Audio Interface	Built-in microphone, 1/1, Cable with 3.5mm Phone Jack
Local Storage	MicroSDHC, MicroSDXC Memory Card Slot (card not included, up to 256GB, Kingston or Sandisk only)
Digital Input/Output	1/1 (Cable with Terminal block)
Operating Button	Reset Button

**General**

Power Source	DC 12V, High PoE (IEEE802.3at)
Power Consumption	18.8 W (PoE, heater and IR on), 15.6 W (DC, heater and IR on)
Weight	2098g (4.625lb)
Dimensions	(W x H x D): 105.11mm x 124.06mm x 368.5mm (4.14" x 4.88" x 14.51")
Environmental Casing	Weatherproof (IP66), Vandal proof metal casing (IK10), Built-in dehumidifier
Bundled Accessories	Integrated bracket
Mount Type	Wall Mount, Ceiling Bracket, Pole Mount, Gang Box

Heater	Yes
Dehumidifier	Yes
Starting Temperature	-40°C ~ 60°C (-40°F ~ 140°F) within 30 minutes
Operating Temperature	-40°C ~ 60°C (-40°F ~ 140°F)
Operating Humidity	10% - 85% RH
Approvals	CE Class B, FCC Class B, EAC, IP66, NEMA 4X, IK10 (metal casing), CNS 16120 (TAICS, TCA) Level 1
Real-time Clock (RTC)	Yes
Warranty	3 Year(s). For extended warranty offering, see <a href="http://www.acti.com/support/warranty">http://www.acti.com/support/warranty</a>

\* cross-browser compatibility: Not available for H.265 video decoding and Intelligent Video settings \*\* Edge Recording function is integrated with NVR 3 Corporate / NVR 3 Business / INR / GNR series.

► Photo Indication



- 1 Ethernet Port
- 2 Audio Input / Output
- 3 DC 12V Power Input
- 4 Reset Button
- 5 Digital Input/Output
- 6 Memory Card Slot (inside the front cover)
- 7 Dehumidifier
- 8 Built-in Microphone

► Dimension Diagram

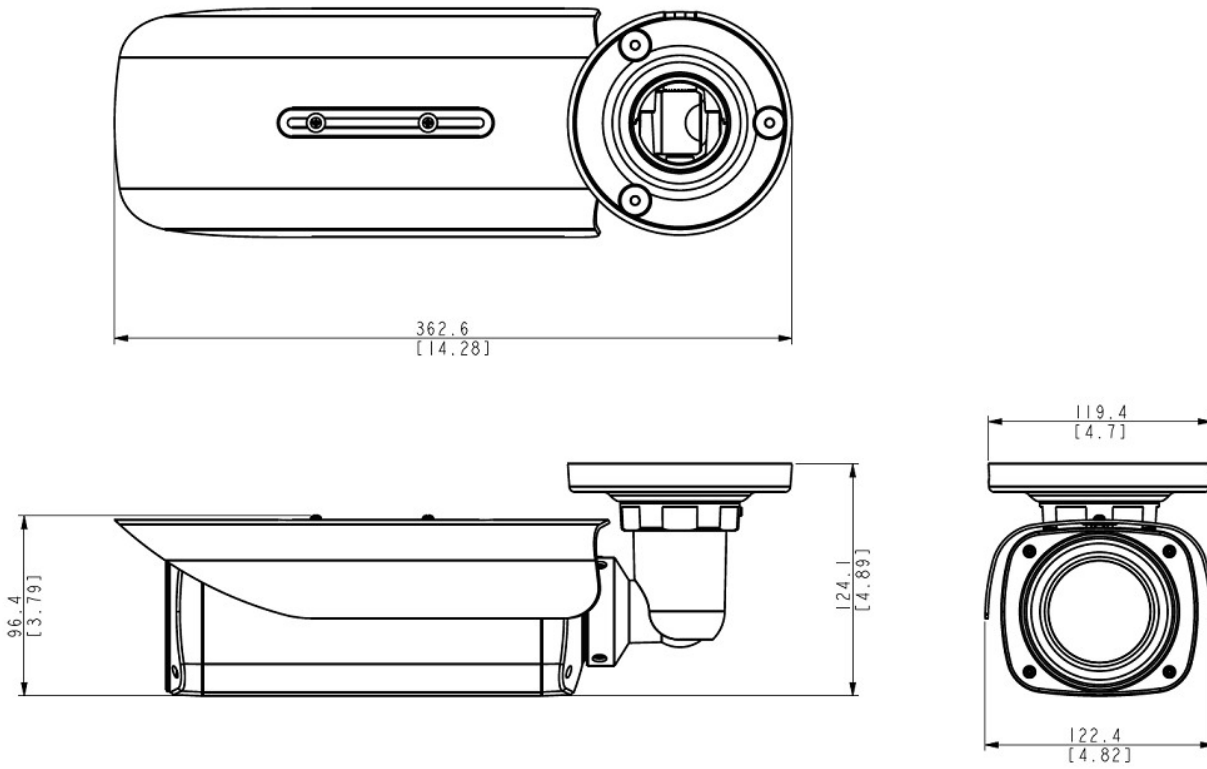









Unit: mm [inch]

## ▶ Related Products

### Bullet - Bullet

E43B		5MP Bullet with D/N, Adaptive IR, Basic WDR, Vari-focal lens, f2.8-12mm/F1.4 (HOV:69.2°-28.2°), H.264, 1080p/30fps, DNR, Audio, MicroSDHC/MicroSDXC, PoE, IP68, IK10 (metal casing), DI/DO
------	---	--

### Mounting Accessories - Camera Mount

PMAX-0504		Pole Mount (for B4x, B41x, E44, E45, E46, E48, E44A, E45A, E46A, E41x, I4x, PMAX-0330), supports 3.25" to 7.0" Poles
PMAX-0505		Pole Mount (for B4x, B41x, E44, E45, E46, E48, E44A, E45A, E46A, E41x, I4x, PMAX-0312, PMAX-0313, PMAX-0314, PMAX-0330), supports 2" to 3" Poles
PMAX-0508		Pole Mount (for PMAX-0203, PMAX-0204, PMAX-0205, PMAX-0206, PMAX-0704), supports 3" to 9" Poles
PMAX-0512		Pole Mount (for E39, PMAX-0706), supports 3.25" to 7.0" Poles
PMAX-0704		Junction Box (for A4x, B4x, B41x, E44, E45, E46, E48, E44A, E45A, E46A, E41x, I4x, PMAX-0203~PMAX-0205)
PMAX-0706		Junction Box (for A3x, A4x, E39, E41x, PMAX-0805)
PMAX-0806		Gang Box Converter (for B4x, E39, E44, E45, E46, E44A, E45A, E46A), supports 4" Round and 4" Octagon Boxes
R706-00006		Back Bracket with Pre-installed (For B41x, B43, I42, I48, E413, E415, E417)

**Note:** Some mounting accessories may need additional accessories for installation. Please check [www.acti.com/mountingselector](http://www.acti.com/mountingselector) for more information.



### Power Supply Accessories - PoE Injector

PPOE-0002		PoE Injector IEEE 802.3af compliant, AC 100~240V, with universal connectors
-----------	---	---

### Network & Storage Peripherals - Data Switch

PPSW-0105		PLANET GS-4210-8P2C 8-Port Gigabit 802.3at Managed PoE Switch (PoE Budget 120W)
-----------	---	---

### Audio Devices - Microphone

PMIC-0100		Active Microphone Omnidirectional for all Cameras with Line-in Audio
PMIC-0200		Passive Microphone Omnidirectional for all Cameras with Mic-in Audio using 3.5mm Phone Jack

### Other Accessories - Camera Part

R716-00001		Sunshield (for B4x, I4x)
------------	---	--------------------------