

B78

12MP Outdoor Hemispheric Dome with D/N, Adaptive IR, Extreme WDR, SLLS, Fixed Lens



- 12 Megapixel with 4K Ultra HD
- Day & Night with Superior Low Light Sensitivity and Adaptive IR LED
- Fisheye Lens with f1.65mm/F2.8
- Extreme WDR
- H.265 Compression
- 360°/180° Panorama View with Dewarped Streaming
- Event trigger, response and notification

► Specifications

Device

Product Type	Hemispheric Dome
Maximum Resolution	12MP
Application Environment	Outdoor
Image Sensor	Progressive Scan CMOS
Sensor Size	1/1.7 "
Effective Pixels	4072(H) X 3046(V) (12.4 MP)
Day / Night	Yes
Low Light Sensitivity	Superior
Minimum Illumination	Color: 0.15 lux; B/W: 0 lux (IR LED on)
Color to B/W Switch	ISP based switch, configurable
Mechanical IR Cut Filter	Yes
IR LED	Adaptive IR LED
IR Working Distance	10m
Electronic Shutter	1/5-1/64000 second (manual mode); 1/5-1/64000 second (auto mode)
Horizontal Resolution (TV Lines)	3000 TVL

Lens	
Focal Length	Fixed focal, f1.65mm
Aperture	F2.8
Iris	Fixed iris
Focus	Fixed focus
Lens Mount	Board mount
Horizontal Viewing Angle	198.5° (overview area) 121.1° (high detail area)
Viewing Angle Adjustment	Rotation: -175°-175°

Video	
Compression	H.265, H.264 (Baseline/ Main/ High profile), MJPEG
Maximum Frame Rate vs. Resolution	(Fisheye View) 30 fps at 3000 x 3000 30 fps at 2048 x 2048 30 fps at 1024 x 1024 30 fps at 640 x 640 (Dewarped View) 30 fps at 4096 x 2160 (4K Ultra HD) 30 fps at 3840 x 2160 (4K Ultra HD) 30 fps at 1920 x 1080 30 fps at 1280 x 960 30 fps at 1280 x 720 30 fps at 800 x 600 30 fps at 640 x 480 (ePTZ View) 30 fps at 800 x 600 30 fps at 640 x 480
View Mode	Fisheye View Dewarped View 270-degree Corner View Multiple View ePTZ View
Multi-Streaming	Simultaneous triple streams based on three configurations
Bit Rate	128Kbps - 12Mbps (per stream)
Bit Rate Mode	Constant, Variable
Wide Dynamic Range	Extreme WDR (130 dB)
Image Enhancement	White Balance, Brightness, Contrast, Sharpness, Automatic gain control, Flickerless, Digital Image Stabilizer (DIS, EIS), Defogging
Digital Noise Reduction	2D + 3D DNR
Privacy Mask	Yes, 4 configurable regions
Text Overlay	Yes
On-Screen Graphics	Yes
Built-in Analytics	Tampering Detection
Server-based Analytics	Object Line Counting, People Counting, Face Detection, Object Based Motion Detection, Tamper, Object Line Crossing Detection, Object Enter Area Detection, Missing Object Detection, Unattended Object Detection, Smoke Detection, Heat Map, Dwell Time, Direction Detection, Automatic License Plate Recognition, People Queue Detection, (Require PC-based or standalone IVS or ALPR Server. Contact ACTi support for recommendations on how to maximize analytical accuracy)
Image Orientation	Flip, Mirror

Audio	
Audio Type	2-way, Built-in Microphone, Mic-in, Line-in, Line-out
Audio Compression	G.711 u-law

Network	
Network Protocol & Service	IPv4/v6, TCP, UDP, DHCP, PPPoE, HTTP, HTTPS, DNS, DDNS, NTP, RTP, RTSP, RTCP, SMTP, FTP, IGMP, ICMP, ARP, Bonjour, UPnP, QoS, SNMP, IEEE 802.1X
Ethernet Port	1 x RJ-45 connector

Security	IP address filtering, HTTPS encryption, Password protected user level, Anonymous login, IEEE 802.1X network access control
----------	--

Video Analytics

Analysis Source Type	Video
Metadata Accuracy	Standard

Event

Event Trigger	Video motion detection (3 regions), External device through digital input, Sound detection, Tampering detection, Video streams loss
Event Response	Notify control center, Change camera settings, Command other devices, E-mail notification with snapshots, Play the audio file, Push notification to mobile device, Save video to local storage, Upload video to NVR server, Upload video or snapshot to FTP server, Activate external device through digital output

System

Watchdog	Support
----------	---------

Integration

Unified Solution	Fully compatible with ACTi software
Software Development Kit	Yes
GPS Position	Manual setting
Edge Recording	Support (integration with NVR by ONVIF Profile G or proprietary protocol)*
ONVIF Compliant	Yes, Profile S, Profile G, Profile T, Profile Q
Web Browser	IE 11
Auto Firmware Upgrade	Yes

Interface

Audio Interface	1/1, Terminal block, Built-in microphone
Analog Video Output	1 x CVBS, Terminal block
Local Storage	MicroSDHC, MicroSDXC Memory Card Slot (card not included, up to 256GB, Kingston or Sandisk only)
Digital Input/Output	1/1 (Terminal block), DC Output Voltage: 5V
Operating Button	Reset Button

General

Power Source	DC 12V, PoE Class 3 (IEEE802.3af)
Power Consumption	12.95 W (PoE)
Weight	954g (2.103lb)
Dimensions	(Ø x H): 152.00mm x 71.00mm (6.0" x 2.8")
Environmental Casing	Weatherproof (IP68), Vandal proof (IK10)
Mount Type	Surface, Rough Surface, Gang Box, Pendant, Tilted Mount, Wall Mount, Pole Mount, Corner Mount
Starting Temperature	-20°C ~ 50°C (-4°F ~ 122°F)
Operating Temperature	-40°C ~ 50°C (-40°F ~ 122°F)

Approvals	CE, FCC, IP68, NEMA 4X, IK10
Real-time Clock (RTC)	Yes
Warranty	3 Year(s). For extended warranty offering, see http://www.acti.com/support/warranty

* Edge Recording function is integrated with NVR 3 Corporate / NVR 3 Business / INR / GNR series.

► Photo Indication

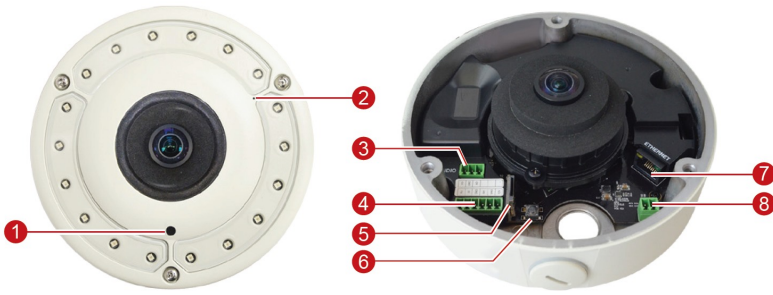

- 1 Light Sensor
- 2 Built-in Microphone
- 3 Audio and Video Output
- 4 Input / Output Connector
 - DC 12V Power Input
 - Digital Input / Output
- 5 Memory Card Slot
- 6 Reset Button
- 7 Ethernet Port
- 8 Audio Input



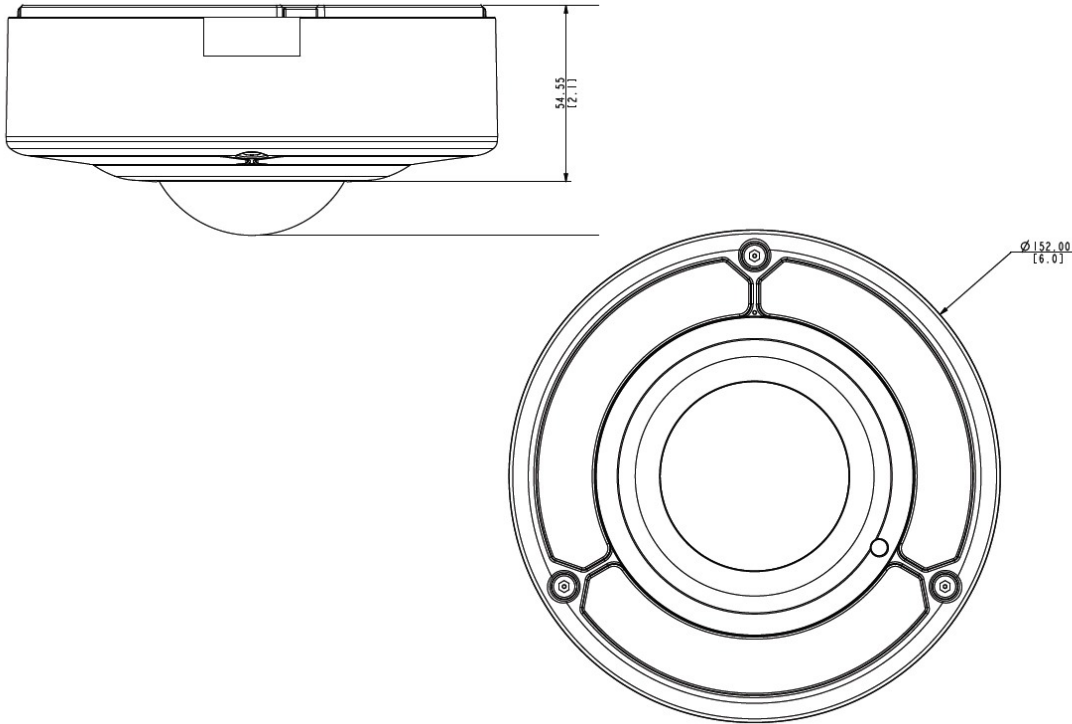















► Dimension Diagram



Unit: mm [inch]

▶ Related Products

Mounting Accessories - Camera Mount

PMAX-0101		Mount Kit for all Dome Cameras (except Mini Domes)
PMAX-0102		Straight Tube
PMAX-0103		Straight Tube with Bracket
PMAX-0104		Extension Tube
PMAX-0302		Gooseneck with Bracket
PMAX-0303		Gooseneck
PMAX-0310		Tilted Wall Mount for Indoor Hemispheric/Fisheye Cameras
PMAX-0314		Heavy Duty Wall Mount for Outdoor Domes (for B8x, B9x, D7x, D8x, E7x [except E78], E8x, I7x)
PMAX-0330		10-Degree Tilted Wall Mount for Outdoor Hemispheric Cameras
PMAX-0338		35-Degree Tilted Wall Mount for Fisheye and Hemispheric Cameras
PMAX-0402		Corner Mount
PMAX-0503		Pole Mount (for PMA-0102, PMA-0312, PMA-0313, PMA-0314, PMA-0702, PMA-1106, PMA-1107), supports 5.25" to 8.5" Poles
PMAX-0504		Pole Mount (for B4x, B41x, E44, E45, E46, E48, E44A, E45A, E46A, E41x, I4x, PMA-0330), supports 3.25" to 7.0" Poles
PMAX-0505		Pole Mount (for B4x, B41x, E44, E45, E46, E48, E44A, E45A, E46A, E41x, I4x, PMA-0312, PMA-0313, PMA-0314, PMA-0330), supports 2" to 3" Poles
PMAX-0702		Junction Box for PTZ and Dome Cameras
PMAX-0804		Gang Box Converter for Outdoor Domes, supports Two-Gang Boxes
PMAX-0807		Gangbox Converter (for PMA-0102, PMA-0312, PMA-0313, PMA-0314, PMA-0321), supports Two-Gang Boxes
PMAX-0808		Converter Ring, 1.5" NPT for Third-Party Mounting Accessories

PMAX-1028



Flush Mount (for B74A, B76A, B77A)

Note: Some mounting accessories may need additional accessories for installation. Please check www.acti.com/mountingselector for more information.

Power Supply Accessories - PoE Injector

PPOE-0002



PoE Injector IEEE 802.3af compliant, AC 100~240V, with universal connectors

Network & Storage Peripherals - Data Switch

PPSW-0105



PLANET GS-4210-8P2C 8-Port Gigabit 802.3at Managed PoE Switch (PoE Budget 120W)

Audio Devices - Microphone

PMIC-0100



Active Microphone Omnidirectional for all Cameras with Line-in Audio

PMIC-0201



Passive Microphone Omnidirectional for all Cameras with Mic-In Audio using Cable Wire or Terminal Connector, 2m cable

Other Accessories - Accessory Part

R707-70001



Conduit Gland for Dome Cameras