

E11A

1MP with Basic WDR,



- 1 Megapixel
- Fixed Lens with f4.2mm/F1.8
- Basic WDR
- Event trigger, response and notification

► Specifications

Device

Product Type	Cube
Maximum Resolution	1MP
Application Environment	Indoor
Image Sensor	Progressive Scan CMOS
Sensor Size	1/4 "
Effective Pixels	1280(H) X 800(V) (1.02 MP)
Day / Night	No
Low Light Sensitivity	Standard
Minimum Illumination	Color: 0.1 lux at F1.8 (30 IRE, 2400 K)
Mechanical IR Cut Filter	No
IR LED	No
Electronic Shutter	1/5-1/2000 second (manual mode); 1/5-1/10000 second (auto mode)
Horizontal Resolution (TV Lines)	700 TVL
S/N Ratio	52 dB

Lens	
Focal Length	Fixed focal, f4.2mm
Aperture	F1.8
Iris	Fixed iris
Focus	Manual focus
Lens Mount	CS Mount (interchangeable lens)
Horizontal Viewing Angle	53.8°
Vertical Viewing Angle	29.1°

Video	
Compression	H.264 (Baseline/ Main/ High profile), MJPEG
Maximum Frame Rate vs. Resolution	30 fps at 1280 x 720 30 fps at 800 x 600 30 fps at 640 x 480 15 fps at 320 x 240
Multi-Streaming	Simultaneous dual streams based on two configurations
Bit Rate	28Kbps - 6Mbps (per stream)
Bit Rate Mode	Constant, Variable
Wide Dynamic Range	Basic WDR (74 dB)
Image Enhancement	White Balance, Brightness, Contrast, Sharpness, Flickerless, Automatic gain control
Digital Noise Reduction	DNR
Privacy Mask	4 configurable regions
Text Overlay	Yes
On-Screen Graphics	Yes
Server-based Analytics	Object Line Counting, People Counting, Face Detection, Object Based Motion Detection, Tamper, Object Line Crossing Detection, Object Enter Area Detection, Missing Object Detection, Unattended Object Detection, Smoke Detection, Heat Map, Dwell Time, People Queue Detection, (Require PC-based or standalone IVS or ALPR Server. Contact ACTi support for recommendations on how to maximize analytical accuracy)
Image Orientation	Flip, Mirror

Audio	
Audio Type	2-way, Built-in Microphone, Line-out
Audio Compression	8 kHz, 16 bit encoding, Mono, PCM, G.711

Network	
Network Protocol & Service	IPv4/v6, TCP, UDP, DHCP, PPPoE, HTTP, HTTPS, DNS, DDNS, NTP, RTP, RTSP, RTCP, SMTP, FTP, IGMP, ICMP, ARP, Bonjour, UPnP, QoS, SNMP, IEEE 802.1X
Ethernet Port	1 x RJ-45 connector
Security	IP address filtering, HTTPS encryption, Password protected user level, Anonymous login, IEEE 802.1X network access control

Event	
Event Trigger	Video motion detection (3 regions), Sound detection,

Event Response	Notify control center, Change camera settings, Command other devices, E-mail notification with snapshots, Push notification to mobile device, Save video to local storage, Upload video or snapshot to FTP server, Upload video to NVR server
----------------	---

Integration

Unified Solution	Fully compatible with ACTi software
Software Development Kit	Yes
GPS Position	Manual setting
ONVIF Compliant	Yes, Profile S, Profile G, Profile T* (To be available through future firmware upgrade), Profile Q
GB28181 Compliant	Yes
Web Browser	IE 11
Auto Firmware Upgrade	Yes

Interface

Audio Interface	Built-in microphone, 3.5mm Phone Jack
Local Storage	MicroSDHC, MicroSDXC Memory Card Slot (card not included, up to 256GB)
Operating Button	Reset Button

General

Power Source	PoE Class 2 (IEEE802.3af)
Power Consumption	3.456 W (PoE)
Weight	242g (0.53lb)
Dimensions	(W x H x D): 96mm x 96mm x 45mm (3.8" x 3.8" x 1.8")
Environmental Casing	No
Bundled Accessories	Bracket
Mount Type	Bracket
Starting Temperature	-10°C ~ 45°C (14°F ~ 113°F)
Operating Temperature	-10°C ~ 45°C (14°F ~ 113°F)
Operating Humidity	10% - 85% RH
Approvals	CE Class B, FCC Class B, EAC, UL (for optional PoE injector)
Real-time Clock (RTC)	No
Warranty	3 Year(s). For extended warranty offering, see http://www.acti.com/support/warranty

► Photo Indication

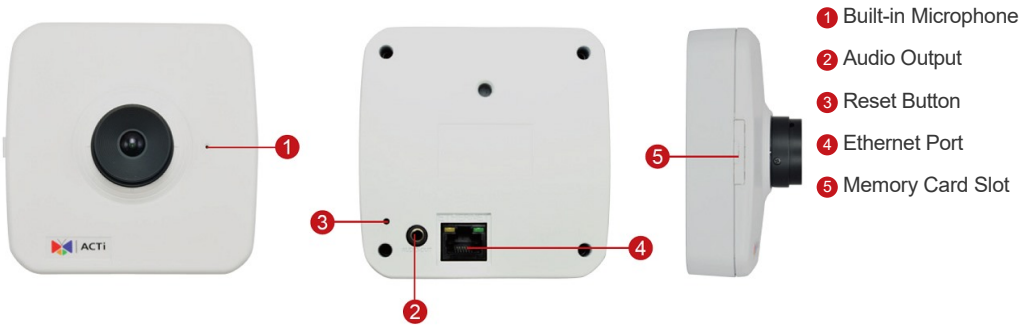

► Dimension Diagram

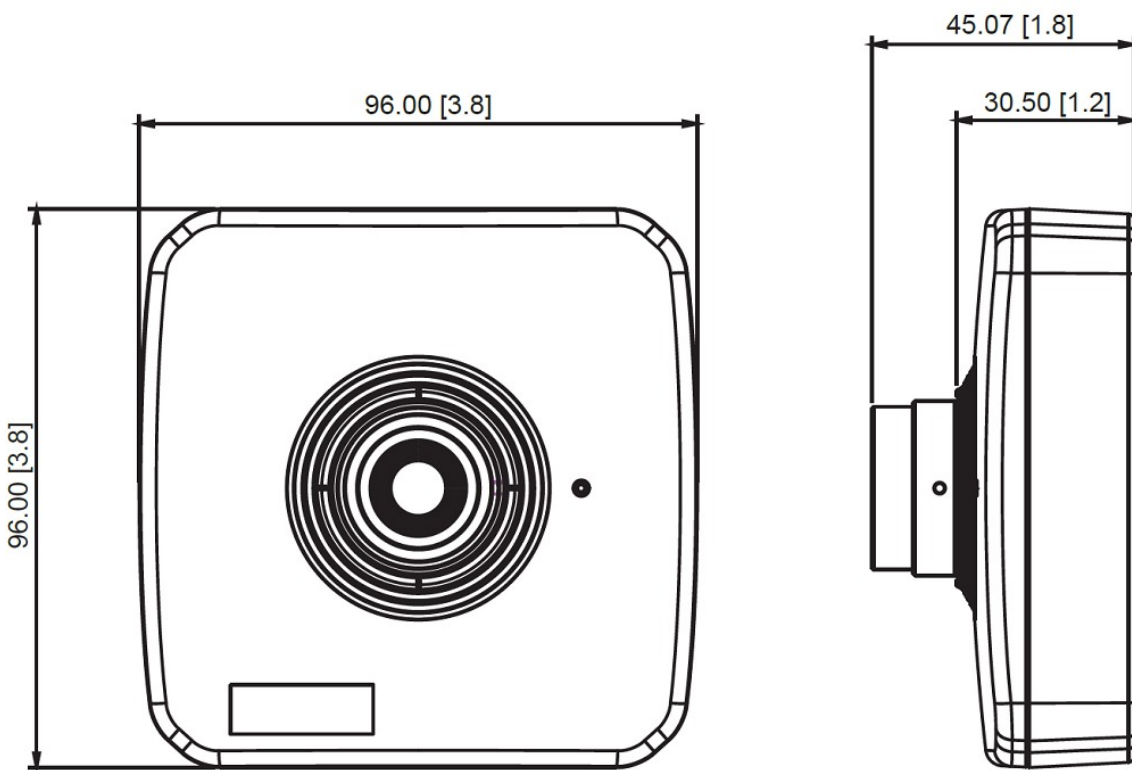

Unit: mm [inch]

▶ Related Products

Lenses - Fixed Lens

PLEN-0101  Fixed Focal f4.2mm, Fixed Iris F1.8, Manual Focus, D/N, Megapixel, CS Mount Lens

Power Supply Accessories - PoE Injector

PPOE-0000  PoE Injector , IEEE 802.3af compliant, AC 100~240V, for US & Japan

PPOE-0001  PoE Injector IEEE 802.3af compliant, AC 100~240V, with universal connectors

Network & Storage Peripherals - Data Switch

PPSW-0100  PLANET FGSD-910HP 8-Port 802.3at PoE Switch (PoE Budget 120W)

PPSW-0101  PLANET GS-4210-8P2T2S 8-Port Gigabit 802.3at Managed PoE Switch (PoE Budget 240W)

PPSW-0102  PLANET FGSD-1011HP 8-Port 802.3at PoE Switch (PoE Budget 120W)

PPSW-1101  PLANET GS-4210-24PL4C 24-Port Gigabit 802.3at Managed PoE Switch (PoE Budget 440W)

PPSW-2101  4-Port 802.3at PoE Switch (PoE Budget 62W)

PPSW-3100  PLANET FGSW-1816HPS 16-Port 802.3at PoE Switch (PoE Budget 220W)

Extenders - PoE Extender

PPEX-0100  Veracity OUTREACH Max Power over Ethernet (PoE) Extender

Extenders - PoE over Coaxial Extender Kit

PPOC-0100  Planet LRP-101C-KIT Power over Coax Adapter Kit

Product Demo - Camera Demo Kit

PCDK-0001  Camera Demo Kit Rack Box (350 x 550 x 140 mm) for all cameras except Mini Domes

Installation Support - Camera Installation Kit

PMON-1001-010  Camera Installation Kit for use with iOS Device with belt bag, battery and charger (US, AC 110~240V)

PMON-1001-011  Camera Installation Kit for use with iOS Device with belt bag, battery and charger (Europe, AC 110~240V)

PMON-2000



Camera Installation Kit