

E33A

5MP with D/N, Adaptive IR, Basic WDR,



- 5 Megapixel
- Day & Night with Adaptive IR LED
- Fixed Lens with f4.2mm/F1.8
- Basic WDR
- Event trigger, response and notification

► Specifications

Device

Product Type	Bullet
Maximum Resolution	5MP
Application Environment	Outdoor
Image Sensor	Progressive Scan CMOS
Sensor Size	1/3.2 "
Effective Pixels	2592(H) X 1944(V) (5.04 MP)
Day / Night	Yes
Low Light Sensitivity	Standard
Minimum Illumination	Color: 0.1 lux at F1.8 (30 IRE, 2400 K); B/W: 0 lux at F1.8 (IR LED on)
Color to B/W Switch	ISP based switch, configurable
Mechanical IR Cut Filter	Yes
IR Sensitivity Range	700-1100nm
IR LED	Adaptive IR LED x 15 (850 nm)
IR Working Distance	30m
Electronic Shutter	1/5-1/2000 second (manual mode); 1/5-1/10000 second (auto mode)

Horizontal Resolution (TV Lines)	1350 TVL
S/N Ratio	52 dB

Lens

Focal Length	Fixed focal, f4.2mm
Aperture	F1.8
Iris	Fixed iris
Focus	Fixed focus
Lens Mount	Board mount
Horizontal Viewing Angle	62.7°
Vertical Viewing Angle	46.5°

Video

Compression	H.264 (Baseline/ Main/ High profile), MJPEG
Maximum Frame Rate vs. Resolution	15 fps at 2592 x 1944 15 fps at 2048 x 1536 30 fps at 1920 x 1080 30 fps at 1280 x 720 30 fps at 800 x 600 30 fps at 640 x 480 15 fps at 320 x 240
Multi-Streaming	Simultaneous dual streams based on two configurations
Bit Rate	28Kbps - 6Mbps (per stream)
Bit Rate Mode	Constant, Variable
Wide Dynamic Range	Basic WDR (74 dB)
Image Enhancement	White Balance, Brightness, Contrast, Sharpness, Automatic gain control, Flickerless
Digital Noise Reduction	DNR
Privacy Mask	4 configurable regions
Text Overlay	Yes
On-Screen Graphics	Yes
Server-based Analytics	Object Line Counting, People Counting, Face Detection, Object Based Motion Detection, Tamper, Object Line Crossing Detection, Object Enter Area Detection, Missing Object Detection, Unattended Object Detection, Smoke Detection, Heat Map, Dwell Time, Direction Detection, Automatic License Plate Recognition, People Queue Detection, (Require PC-based or standalone IVS or ALPR Server. Contact ACTi support for recommendations on how to maximize analytical accuracy)
Image Orientation	Flip, Mirror

Network

Network Protocol & Service	IPv4/v6, TCP, UDP, DHCP, PPPoE, HTTP, HTTPS, DNS, DDNS, NTP, RTP, RTSP, RTCP, SMTP, FTP, IGMP, ICMP, ARP, Bonjour, UPnP, QoS, SNMP, IEEE 802.1X
Ethernet Port	1 x RJ-45 pigtail connector
Security	IP address filtering, HTTPS encryption, Password protected user level, Anonymous login, IEEE 802.1X network access control

Event

Event Trigger	Video motion detection (3 regions),
---------------	-------------------------------------

Event Response	Notify control center, Change camera settings, Command other devices, E-mail notification with snapshots, Push notification to mobile device, Save video to local storage, Upload video or snapshot to FTP server, Upload video to NVR server
----------------	---

System

Watchdog	Support
----------	---------

Integration

Unified Solution	Fully compatible with ACTi software
Software Development Kit	Yes
GPS Position	Manual setting
Edge Recording	Support (integration with NVR by ONVIF Profile G or proprietary protocol)*
ONVIF Compliant	Yes, Profile S, Profile G, Profile T, Profile Q
GB28181 Compliant	Yes
Web Browser	IE 11
Auto Firmware Upgrade	Yes

Interface

Local Storage	MicroSDHC, MicroSDXC Memory Card Slot (card not included, up to 256GB, Kingston or Sandisk only)
Operating Button	Reset Button

General

Power Source	PoE Class 2 (IEEE802.3af)
Power Consumption	5.04 W (PoE)
Weight	704g (1.29lb)
Dimensions	(Ø x L): 77mm x 190mm (3.03" x 7.48")
Environmental Casing	Weatherproof (IP68), Vandal proof metal casing (IK10)
Bundled Accessories	Bracket
Mount Type	Bracket, Pole Mount, Corner Mount
Starting Temperature	-20°C ~ 50°C (-4°F ~ 122°F)
Operating Temperature	-40°C ~ 50°C (-40°F ~ 122°F)
Operating Humidity	10% - 85% RH
Approvals	CE, FCC, EAC, BIS, IP68, NEMA 4X, IK10 (metal casing), UL (for optional PoE injector)
Warranty	3 Year(s). For extended warranty offering, see http://www.acti.com/support/warranty

* Edge Recording function is integrated with NVR 3 Corporate / NVR 3 Business / INR / GNR series.

► Photo Indication





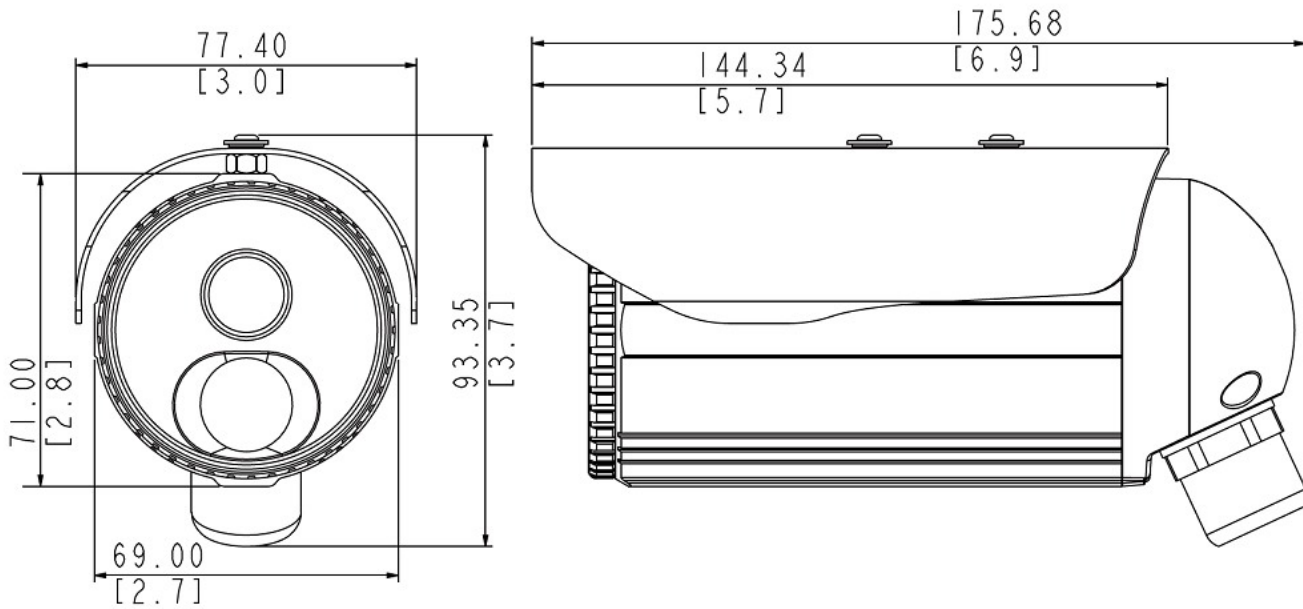



► Dimension Diagram







Unit: mm [inch]

▶ Related Products

Bullet - Mini Bullet

A310		4MP Mini Bullet with D/N, IR, Extreme WDR, SLLS, Fixed lens, f2.8mm/F1.6 (HOV:101.3°), H.265/H.264, 1080p/30fps, 2D+3D DNR, MicroSD/MicroSDHC/MicroSDXC, PoE/DC12V, IP68, IK10 (metal casing)
A311		6MP Mini Bullet with D/N, IR, Extreme WDR, SLLS, Fixed lens, f2.8mm/F2.0 (HOV:97°), H.265/H.264, 1440p/30fps, 3D DNR, MicroSD/MicroSDHC/MicroSDXC, PoE/DC12V, IP67, IK10 (metal casing)
A314		6MP Mini Bullet with D/N, IR, Extreme WDR, SLLS, Fixed lens, f2.8mm/F1.6, H.265/H.264, 3D DNR, MicroSD/MicroSDHC/MicroSDXC, PoE/DC12V, IP67, IK10
Z310		8MP Mini Bullet with D/N, Adaptive IR, Superior WDR, SLLS, Fixed lens, f2.8mm/F1.6 (HOV:99°), H.265/H.264, 1440p/30fps, 2D+3D DNR, Built-in Microphone, MicroSDHC/MicroSDXC, PoE/DC12V, IP67
Z38		2MP Mini Bullet with D/N, Adaptive IR, Superior WDR, SLLS, Fixed lens, f2.8mm/F2.0 (HOV:102.1°), H.265/H.264, 1080p/30fps, 2D+3D DNR, Built-in Microphone, MicroSD, PoE/DC12V, IP68, IK10 (metal casing)
Z39		4MP Mini Bullet with D/N, Adaptive IR, Superior WDR, SLLS, Fixed lens, f2.8mm/F1.6 (HOV:99°), H.265/H.264, 1440p/30fps, 2D+3D DNR, Built-in Microphone, MicroSD, PoE/DC12V, IP67

Mounting Accessories - Camera Mount

PMAX-0402		Corner Mount
PMAX-0503		Pole Mount (for PMAX-0102, PMAX-0312, PMAX-0313, PMAX-0314, PMAX-0702, PMAX-1106, PMAX-1107), supports 5.25" to 8.5" Poles
PMAX-1107		Bracket for Bullet Cameras (D3x, D4x, E3x, E41~E43, E47 only)
R707-00002		Bracket (for E33A, E41, E42B, E43B)

Note: Some mounting accessories may need additional accessories for installation. Please check www.acti.com/mountingselector for more information.

Lenses - Fixed Lens

PLEN-0114		Fixed Focal f4.2mm, Fixed Iris F1.8, Fixed Focus, D/N, Megapixel, Board Mount Lens
-----------	---	--

Bullet Covers - Back Cover

R706-00005		Back Cover with Pre-installed Network Cable (for E3x, except E38)
------------	---	---

Bullet Covers - Front Cover

R700-00004		Front Cover (for E3x bullet cameras)
------------	---	--------------------------------------

Power Supply Accessories - PoE Injector

PPOE-0000		PoE Injector IEEE 802.3af compliant, AC 100~240V, for US & Japan
-----------	---	--

PPOE-0002		PoE Injector IEEE 802.3af compliant, AC 100~240V, with universal connectors
-----------	---	---

Network & Storage Peripherals - Data Switch

PPSW-0100		PLANET FGSD-910HP 8-Port 802.3at PoE Switch (PoE Budget 120W)
-----------	---	---

PPSW-0102		PLANET FGSD-1011HP 8-Port 802.3at PoE Switch (PoE Budget 120W)
-----------	---	--

PPSW-0105		PLANET GS-4210-8P2C 8-Port Gigabit 802.3at Managed PoE Switch (PoE Budget 120W)
-----------	---	---

PPSW-1101		PLANET GS-4210-24PL4C 24-Port Gigabit 802.3at Managed PoE Switch (PoE Budget 440W)
-----------	---	--

PPSW-2101		4-Port 802.3at PoE Switch (PoE Budget 62W)
-----------	---	--

PPSW-3100		PLANET FGSW-1816HPS 16-Port 802.3at PoE Switch (PoE Budget 220W)
-----------	---	--

Extenders - PoE Extender

PPEX-0100		Veracity OUTREACH Max Power over Ethernet (PoE) Extender
-----------	---	--

Extenders - PoE over Coaxial Extender Kit

PPOC-0100		Planet LRP-101C-KIT Power over Coax Adapter Kit
-----------	---	---

Illuminators - IR LED Illuminator

PLED-0200		SPINLUX (SL-A2IRXX10-24CL) IR Illuminator 10° Angle with 120 m approx. range
-----------	---	--

PLED-0201		SPINLUX (SL-A2IRXX25-24CL) IR Illuminator 25° Angle with 50 m approx. range
-----------	---	---

PLED-0202		SPINLUX (SL-A2IRXX35-24CL) IR Illuminator 35° Angle with 25 m approx. range
-----------	---	---

Other Accessories - Tool

R707-X0001		Lens Focus Tuner
------------	---	------------------

Product Demo - Camera Demo Kit

PCDK-0001		Camera Demo Kit Rack Box (350 x 550 x 140 mm) for all cameras except Mini Domes
-----------	---	---