

E41

1MP with D/N, Adaptive IR, Basic WDR, Vari-focal Lens



- 1 Megapixel
- Day & Night with Adaptive IR LED
- Vari-focal Lens with f3.3-12mm/F1.6
- Basic WDR
- Event trigger, response and notification

► Specifications

Device

Product Type	Bullet
Maximum Resolution	1MP
Application Environment	Outdoor
Image Sensor	Progressive Scan CMOS
Sensor Size	1/4 "
Effective Pixels	1280(H) X 800(V) (1.02 MP)
Day / Night	Yes
Low Light Sensitivity	Standard
Minimum Illumination	Color: 0.1 lux at F1.6 (30 IRE, 2400 K); B/W: 0 lux at F1.6 (IR LED on)
Color to B/W Switch	ISP based switch, configurable
Mechanical IR Cut Filter	Yes
IR Sensitivity Range	700-1100nm
IR LED	Adaptive IR LED x 15 (850 nm)
IR Working Distance	30m
Electronic Shutter	1/5-1/2000 second (manual mode); 1/5-1/10000 second (auto mode)

Horizontal Resolution (TV Lines)	700 TVL
S/N Ratio	52 dB

Lens

Focal Length	Vari-focal, f3.3-12mm
Aperture	F1.6
Iris	Fixed iris
Focus	Manual focus
Lens Mount	Board mount
Horizontal Viewing Angle	69.8° - 19.1°
Vertical Viewing Angle	36.9°

Video

Compression	H.264 (Baseline/ Main/ High profile), MJPEG
Maximum Frame Rate vs. Resolution	30 fps at 1280 x 720 30 fps at 800 x 600 30 fps at 640 x 480 15 fps at 320 x 240
Multi-Streaming	Simultaneous dual streams based on two configurations
Bit Rate	28Kbps - 6Mbps (per stream)
Bit Rate Mode	Constant, Variable
Wide Dynamic Range	Basic WDR (74 dB)
Image Enhancement	White Balance, Brightness, Contrast, Sharpness, Automatic gain control, Flickerless
Digital Noise Reduction	DNR
Privacy Mask	4 configurable regions
Text Overlay	Yes
On-Screen Graphics	Yes
Server-based Analytics	Object Line Counting, People Counting, Face Detection, Object Based Motion Detection, Tamper, Object Line Crossing Detection, Object Enter Area Detection, Missing Object Detection, Unattended Object Detection, Smoke Detection, Heat Map, Dwell Time, Direction Detection, Automatic License Plate Recognition, People Queue Detection, (Require PC-based or standalone IVS or ALPR Server. Contact ACTi support for recommendations on how to maximize analytical accuracy)
Image Orientation	Flip, Mirror

Network

Network Protocol & Service	IPv4/v6, TCP, UDP, DHCP, PPPoE, HTTP, HTTPS, DNS, DDNS, NTP, RTP, RTSP, RTCP, SMTP, FTP, IGMP, ICMP, ARP, Bonjour, UPnP, QoS, SNMP, IEEE 802.1X
Ethernet Port	1 x RJ-45 pigtail connector
Security	IP address filtering, HTTPS encryption, Password protected user level, Anonymous login, IEEE 802.1X network access control

Event

Event Trigger	Video motion detection (3 regions),
---------------	-------------------------------------

Event Response

Notify control center, Change camera settings, Command other devices, E-mail notification with snapshots, Push notification to mobile device, Upload video or snapshot to FTP server, Upload video to NVR server

System

Watchdog	Support
----------	---------

Integration

Unified Solution	Fully compatible with ACTi software
Software Development Kit	Yes
GPS Position	Manual setting
ONVIF Compliant	Yes, Profile S, Profile T, Profile Q
GB28181 Compliant	Yes
Web Browser	IE 11
Auto Firmware Upgrade	Yes

Interface

Operating Button	Reset Button
------------------	--------------

General

Power Source	PoE Class 2 (IEEE802.3af)
Power Consumption	3.74 W (PoE)
Weight	643g (1.418lb)
Dimensions	(Ø x L): 77mm x 213mm (3.03" x 8.39")
Environmental Casing	Weatherproof (IP68), Vandal proof metal casing (IK10)
Bundled Accessories	Bracket
Mount Type	Bracket, Pole Mount, Corner Mount
Starting Temperature	-20°C ~ 50°C (-4°F ~ 122°F)
Operating Temperature	-40°C ~ 50°C (-40°F ~ 122°F)
Operating Humidity	10% - 85% RH
Approvals	CE Class B, FCC Class B, EAC, IP68, NEMA 4X, IK10 (metal casing), UL (for optional PoE injector)
Real-time Clock (RTC)	No
Warranty	3 Year(s). For extended warranty offering, see http://www.acti.com/support/warranty

► Photo Indication





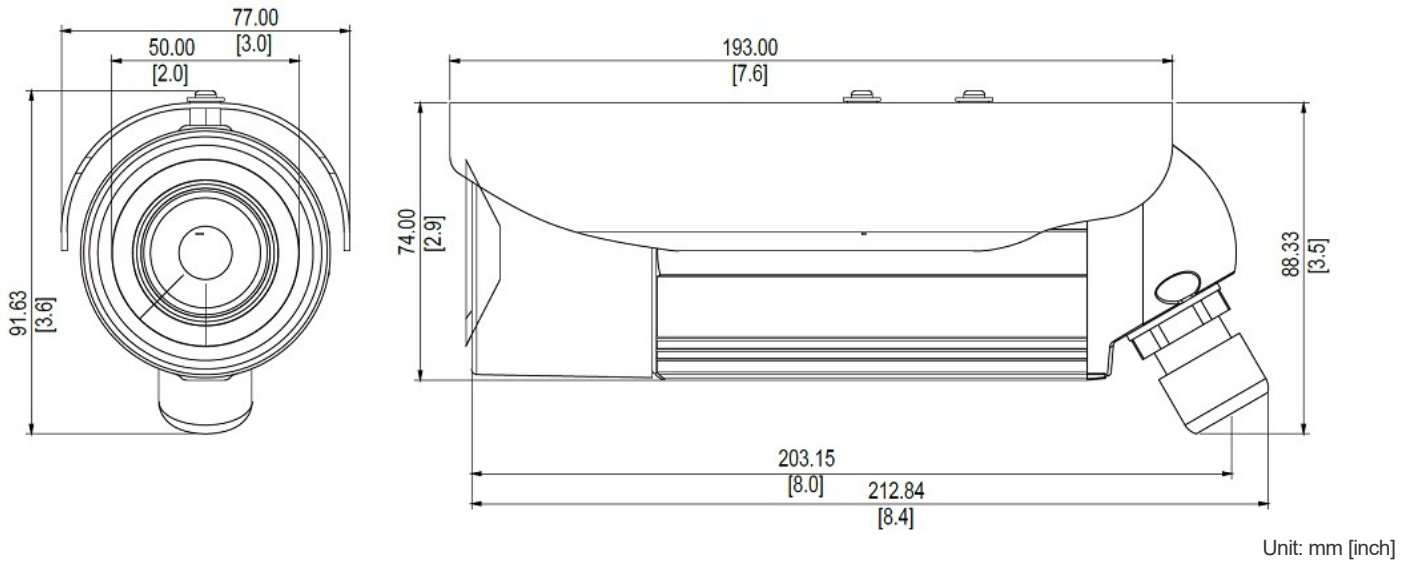









► Dimension Diagram







▶ Related Products

Bullet - Zoom Bullet

A42		5MP Zoom Bullet with D/N, Adaptive IR, Extreme WDR, SLLS, 2.8x Zoom lens, f3.6-10mm/F1.5-2.8 (HOV:79.5°-38.1°), P-Iris, Auto Focus (for installation), H.265/H.264, 1080p/60fps, 2D+3D DNR, Audio, PoE/DC12V, IP66, IK10 (metal casing), DI/DO
A421		8MP Video Analytics Zoom Bullet with D/N, Adaptive IR, Extreme WDR, SLLS, 4.3x Zoom lens, f2.8-12mm/F1.3, Auto Focus (for installation), H.265/H.264, 4K/30fps, 2D+3D DNR, Audio, MicroSDHC/MicroSDXC, PoE/DC12V, IP66, IK10 (metal casing), DI/DO, Built-in Analytics
A425		2MP Zoom Bullet with D/N, Adaptive IR, Extreme WDR, ELLS, 4.3x Zoom lens, f2.8-12mm/F1.8-3.3 (HOV:106.6°-34.6°), Adaptive iris, Auto Focus (for installation), H.265/H.264, 1080p/60fps, 2D+3D DNR, Audio, MicroSDHC/MicroSDXC, PoE/DC12V, IP67, IK10 (metal casing), DI/DO
A46		5MP Zoom Bullet with D/N, Adaptive IR, Extreme WDR, SLLS, 5x Zoom lens, f2.7-13.5mm, Auto Focus (for installation), H.265/H.264, 1080p/30fps, 2D+3D DNR, Audio, MicroSDHC/MicroSDXC, PoE/DC12V, IP66, IK10 (metal casing), DI/DO
B412		3MP Video Analytics Zoom Bullet with D/N, Adaptive IR, Extreme WDR, SLLS, 10x Zoom lens, f4.7-47mm/F1.6-3.0 (HOV:58°-5.8°), DC iris, Auto Focus, H.265/H.264, 1080p/60fps, 2D+3D DNR, Built-in Microphone, MicroSDHC/MicroSDXC, High PoE/DC12V, IP67, IK10 (metal casing), DI/DO, Built-in Analytics
B419		5MP Video Analytics Zoom Bullet with D/N, Adaptive IR, Extreme WDR, SLLS, 10x Zoom lens, f4.7-47mm/F1.6-3.0 (HOV:50.67°-5.14°), DC iris, Auto Focus, H.265/H.264, 1080p/30fps, 2D+3D DNR, Built-in Microphone, MicroSDHC/MicroSDXC, High PoE/DC12V, IP67, IK10 (metal casing), DI/DO, Built-in Analytics
B44		1.3MP Zoom Bullet with D/N, Adaptive IR, Basic WDR, SLLS, 10x Zoom lens, f4.9-49mm/F1.6-3.0 (HOV:52.1°-5.7°), DC iris, Auto Focus, H.264, 720p/60fps, DNR, Audio, MicroSDHC/MicroSDXC, PoE/DC12V, IP67, IK10 (metal casing), DI/DO
I42		2MP Video Analytics Zoom Bullet with D/N, Adaptive IR, Extreme WDR, ELLS, 36x Zoom lens, f4.6-165.6mm/F1.55-5.0 (HOV:62.7°-2.7°), DC iris, Auto Focus, H.264, 1080p/60fps, 2D+3D DNR, Audio, MicroSDHC/MicroSDXC, PoE/DC12V, IP67, IK10 (metal casing), DI/DO, Built-in Analytics
I47		4MP Zoom Bullet with D/N, Adaptive IR, Advanced WDR, SLLS, 30x Zoom lens, f4.3-129mm/F1.6-5.0 (HOV:66.4°-2.14°), DC iris, Auto Focus, H.264, 1080p/30fps, 2D+3D DNR, Audio, MicroSDHC/MicroSDXC, PoE/DC12V, IP67, IK10 (metal casing), DI/DO
Z42		4MP Zoom Bullet with D/N, Adaptive IR, Superior WDR, SLLS, 4.3x Zoom lens, f2.8-12mm (HOV:91°-27°), Auto Focus (for installation), H.265/H.264, 2D+3D DNR, MicroSDHC/MicroSDXC, PoE/DC12V, IP67, IK10 (metal casing)
Z47		8MP Zoom Bullet with D/N, Adaptive IR, Superior WDR, SLLS, 4.3x Zoom lens, f2.8-12mm/F1.6 (HOV:99.8°-31.1°), Auto Focus (for installation), H.265/H.264, 1440p/30fps, 2D+3D DNR, Audio, MicroSD, PoE/DC12V, IP67, IK10 (metal casing), DI/DO
Z48		2MP Zoom Bullet with D/N, Adaptive IR, Superior WDR, SLLS, 4.3x Zoom lens, f2.8-12mm/F1.6 HOV:102.1°-33°), Auto Focus (for installation), H.265/H.264, 1080p/30fps, 2D+3D DNR, Built-in Microphone, MicroSD, PoE/DC12V, IP67, IK10 (metal casing)

Z49		4MP Zoom Bullet with D/N, Adaptive IR, Superior WDR, SLLS, 4.3x Zoom lens, f2.8-12mm/F1.6 (HOV:102.1°-30.7°), Auto Focus (for installation), H.265/H.264, 1440p/30fps, 2D+3D DNR, Built-in Microphone,, MicroSD, PoE/DC12V, IP68, IK10 (metal casing)
-----	---	---

Mounting Accessories - Camera Mount

PMAX-0402		Corner Mount
PMAX-0503		Pole Mount (for PMAX-0102, PMAX-0312, PMAX-0313, PMAX-0314, PMAX-0702, PMAX-1106, PMAX-1107), supports 5.25" to 8.5" Poles
PMAX-1107		Bracket for Bullet Cameras (D3x, D4x, E3x, E41~E43, E47 only)
R707-00002		Bracket (for E33A, E41, E42B, E43B)

Note: Some mounting accessories may need additional accessories for installation. Please check www.acti.com/mountingselector for more information.



Bullet Covers - Back Cover

R706-00001		Back Cover with Pre-installed Network Cable (for D4x, E4x bullet cameras)
------------	---	---







Bullet Covers - Front Cover

R700-00005		Front Cover (for D4x, E4x bullet cameras, except E48)
------------	---	---

Power Supply Accessories - PoE Injector

PPOE-0000		POE Injector IEEE 802.3af compliant, AC 100~240V, for US & Japan
PPOE-0002		PoE Injector IEEE 802.3af compliant, AC 100~240V, with universal connectors

Network & Storage Peripherals - Data Switch

PPSW-0100		PLANET FGSD-910HP 8-Port 802.3at PoE Switch (PoE Budget 120W)
PPSW-0102		PLANET FGSD-1011HP 8-Port 802.3at PoE Switch (PoE Budget 120W)
PPSW-0105		PLANET GS-4210-8P2C 8-Port Gigabit 802.3at Managed PoE Switch (PoE Budget 120W)
PPSW-1101		PLANET GS-4210-24PL4C 24-Port Gigabit 802.3at Managed PoE Switch (PoE Budget 440W)
PPSW-2101		4-Port 802.3at PoE Switch (PoE Budget 62W)
PPSW-3100		PLANET FGSW-1816HPS 16-Port 802.3at PoE Switch (PoE Budget 220W)

Extenders - PoE Extender

PPEX-0100  Veracity OUTREACH Max Power over Ethernet (PoE) Extender

Extenders - PoE over Coaxial Extender Kit

PPOC-0100  Planet LRP-101C-KIT Power over Coax Adapter Kit

Illuminators - IR LED Illuminator

PLED-0200  SPINLUX (SL-A2IRXX10-24CL) IR Illuminator 10° Angle with 120 m approx. range

PLED-0201  SPINLUX (SL-A2IRXX25-24CL) IR Illuminator 25° Angle with 50 m approx. range

PLED-0202  SPINLUX (SL-A2IRXX35-24CL) IR Illuminator 35° Angle with 25 m approx. range

Product Demo - Camera Demo Kit

PCDK-0001  Camera Demo Kit Rack Box (350 x 550 x 140 mm) for all cameras except Mini Domes