

# E78

2MP with D/N, Adaptive IR, Extreme WDR, SLLS,



- 2 Megapixel
- Day & Night with Superior Low Light Sensitivity and Adaptive IR LED
- Fixed Lens with f3.6mm/F1.85
- Extreme WDR
- Wide Angle
- Event trigger, response and notification

## ► Specifications

### Device

Product Type	Dome
Maximum Resolution	2MP
Application Environment	Outdoor
Image Sensor	Progressive Scan CMOS
Sensor Size	1/2.8 "
Effective Pixels	1944(H) X 1224(V) (2.38 MP)
Day / Night	Yes
Low Light Sensitivity	Superior
Minimum Illumination	Color: 0.1 lux at F1.85 (30 IRE, 2400 K); B/W: 0 lux at F1.85 (IR LED on)
Color to B/W Switch	ISP based switch, configurable
Mechanical IR Cut Filter	Yes
IR Sensitivity Range	700-1100nm
IR LED	Adaptive IR LED x 10 (850 nm)
IR Working Distance	30m (0 lux, 30IRE, Gain 255, Auto shutter mode)
Electronic Shutter	1/5-1/32000 second (manual mode); 1/5-1/32000 second (auto mode)

Horizontal Resolution (TV Lines)	1100 TVL
S/N Ratio	56 dB

## Lens

Focal Length	Fixed focal, f3.6mm
Aperture	F1.85
Iris	Fixed iris
Focus	Fixed focus
Lens Mount	Board mount
Horizontal Viewing Angle	84.5°
Vertical Viewing Angle	47.3°
Viewing Angle Adjustment	Pan: 0°-350°, Tilt: 5°-175°, Rotation: 0°-350°

## Video

Compression	H.264 (Baseline/ Main/ High profile), MJPEG
Maximum Frame Rate vs. Resolution	60 fps at 1920 x 1080 60 fps at 1280 x 720 30 fps at 640 x 480 30 fps at 320 x 240
High Frame Mode	Support
Multi-Streaming	Simultaneous triple streams based on three configurations
Bit Rate	128Kbps - 12Mbps (per stream)
Bit Rate Mode	Constant, Variable
Wide Dynamic Range	Extreme WDR (145 dB)
Image Enhancement	White Balance, Brightness, Contrast, Sharpness, Automatic gain control, Flickerless, Digital Image Stabilizer (DIS, EIS), Defogging
Digital Noise Reduction	2D + 3D DNR
Privacy Mask	4 configurable regions
Text Overlay	Yes
On-Screen Graphics	Yes
Built-in Analytics	Basic Face Detection, Object Based Motion Detection, Tampering Detection, Object Line Crossing Detection, Object Enter Area Detection, Missing Object Detection, Unattended Object Detection, Object Loitering Detection
Server-based Analytics	Object Line Counting, People Counting, Face Detection, Object Based Motion Detection, Tamper, Object Line Crossing Detection, Object Enter Area Detection, Missing Object Detection, Unattended Object Detection, Smoke Detection, Heat Map, Dwell Time, Direction Detection, Automatic License Plate Recognition, People Queue Detection, (Require PC-based or standalone IVS or ALPR Server. Contact ACTi support for recommendations on how to maximize analytical accuracy)
Image Orientation	Flip, Mirror, Rotation (Corridor mode)
IVS performance	Certain algorithms may require more computing power, which may limit the number of algorithms that can be concurrently used in the camera. Please test the actual performance before using in a project.

## Audio

Audio Type	2-way, Mic-in, Line-in, Line-out
------------	----------------------------------

Audio Compression	8 kHz, 16 bit encoding, Mono, PCM, G.711
-------------------	------------------------------------------

## Network

Network Protocol & Service	IPv4/v6, TCP, UDP, DHCP, PPPoE, HTTP, HTTPS, DNS, DDNS, NTP, RTP, RTSP, RTCP, SMTP, FTP, IGMP, ICMP, ARP, Bonjour, UPnP, QoS, SNMP, IEEE 802.1X
Ethernet Port	1 x RJ-45 pigtail connector
Security	IP address filtering, HTTPS encryption, Password protected user level, Anonymous login, IEEE 802.1X network access control

## Video Analytics

Analysis Source Type	Video
Metadata Accuracy	Standard

## Event

Event Trigger	Video motion detection (10 included and excluded polygons regions), External device through digital input, Sound detection, Intelligent event detection, Video streams loss, System log buffer overrun, Remove system log, Logon events (Login Failure, Login Success, Block an Account)
Event Response	Notify control center, Change camera settings, Command other devices, E-mail notification with snapshots, Push notification to mobile device, Save video to local storage, Upload video to NVR server, Upload video or snapshot to FTP server, Activate external device through digital output

## System

System Log	Support
------------	---------

## Integration

Unified Solution	Fully compatible with ACTi software
Software Development Kit	Yes
GPS Position	Manual setting
ONVIF Compliant	Yes, Profile S, Profile G, Profile T, Profile Q
GB28181 Compliant	Yes
Web Browser	IE 11, Google Chrome*, Microsoft Edge*, Apple Safari*
Auto Firmware Upgrade	Yes

## Interface

Audio Interface	Terminal block
Local Storage	MicroSDHC, MicroSDXC Memory Card Slot (card not included, up to 256GB, Kingston or Sandisk only)
Digital Input/Output	1/1
Operating Button	Reset Button

## General

Power Source	DC 12V, PoE Class 2 (IEEE802.3af)
Power Consumption	5.04 W (PoE)
Weight	551g (1.21lb)
Dimensions	(Ø x H): 115mm x 87mm (5.53" x 3.43")

Environmental Casing	Weatherproof (IP68), Vandal proof (IK10)
Mount Type	Surface, Gang Box, Flush, Pendant, Converter for NPT Standard Mounts, Wall Mount, Pole Mount, Corner Mount
Starting Temperature	-40°C ~ 50°C (-40°F ~ 122°F)
Operating Temperature	-40°C ~ 50°C (-40°F ~ 122°F)
Operating Humidity	10% - 85% RH
Approvals	CE Class B, FCC Class B, EAC, IP66, IK10, NEMA 4X, UL (for optional PoE injector and power adapter)
Real-time Clock (RTC)	Yes
Warranty	3 Year(s). For extended warranty offering, see <a href="http://www.acti.com/support/warranty">http://www.acti.com/support/warranty</a>

\* cross-browser compatibility: Not available for H.265 video decoding

► Photo Indication

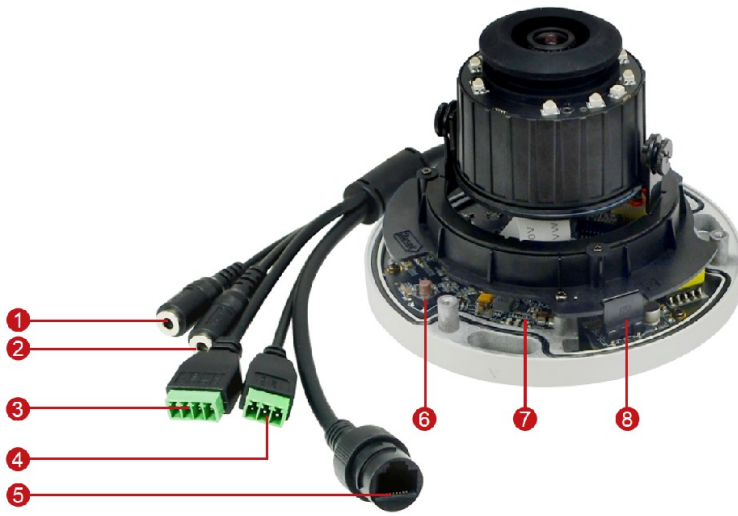

- 1 Mic Input
- 2 Audio Output
- 3 Digital Input/Output
- 4 DC 12V Input
- 5 Ethernet Port
- 6 Reset Button
- 7 System LEDs
- 8 Memory Card Slot



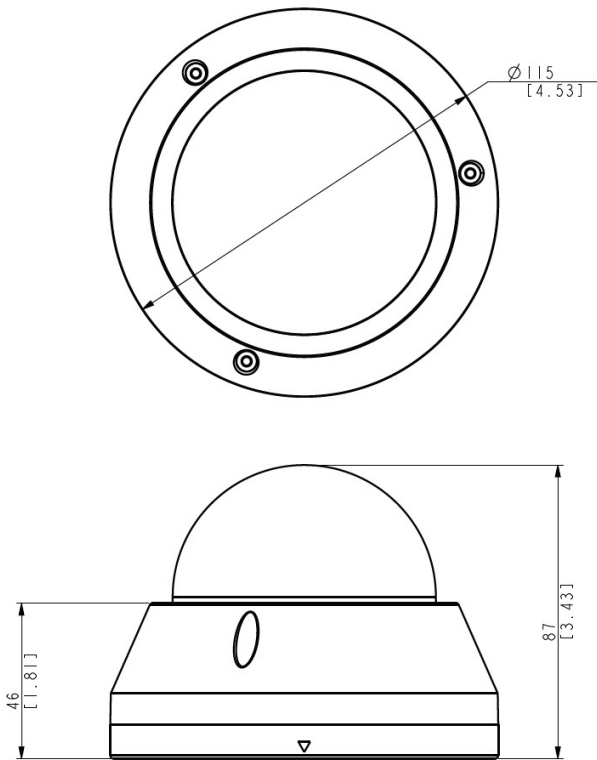







► Dimension Diagram



Unit: mm [inch]

## ► Related Products

### Mounting Accessories - Camera Mount

PMAX-0111		Straight Tube (for D5x, D9x, E5x, E9x, E9xx/M)
PMAX-0112		Extension Tube (for D5x, D9x, E5x, E9x, E9xx/M)
PMAX-0122		Straight Tube (for A71, A88, A9x,)
PMAX-0123		Extension Tube (for A71, A88, A9x,)
PMAX-0316		Wall Mount (for D5x, D9x, E5x, E78, E9x, E9xx/M)
PMAX-0506		Pole Mount (for A31, A4x, E78, E9x, E9xx), supports 2" to 3" Poles
PMAX-0805		Gang Box Converter (for D5x, D9x, E5x, E78, E9x, E9xx/M), supports 4" Round and 4" Octagon Boxes
PMAX-0809		Converter Ring, 1.0" NPT for Third-Party Mounting Accessories
PMAX-1021		Flush Mount for E78
PMAX-1032		Flush Mount (for A71, A74, E78, E79, E710)
PMAX-1400		Mount Kit (for D5x, D9x, E5x, E78, E9x, E9xx/M)

**Note:** Some mounting accessories may need additional accessories for installation. Please check [www.acti.com/mountingselector](http://www.acti.com/mountingselector) for more information.

### Dome Covers - Transparent Dome Cover

R701-70011		Transparent Dome Cover (for E78, E79, E710)
------------	-------------------------------------------------------------------------------------	---------------------------------------------

### Dome Covers - Smoked Dome Cover

PDCX-1113		Vandal Proof Smoked Dome Cover for E78
-----------	-------------------------------------------------------------------------------------	----------------------------------------

### Power Supply Accessories - Power Adapter

PPBX-0011		Power Adapter AC 100~240V, with universal connectors for all DC12V powered devices
-----------	-------------------------------------------------------------------------------------	------------------------------------------------------------------------------------

### Network & Storage Peripherals - Data Switch

PPSW-0100		PLANET FGSD-910HP 8-Port 802.3at PoE Switch (PoE Budget 120W)
-----------	-------------------------------------------------------------------------------------	---------------------------------------------------------------

PPSW-0102  PLANET FGSD-1011HP 8-Port 802.3at PoE Switch (PoE Budget 120W)

PPSW-1101  PLANET GS-4210-24PL4C 24-Port Gigabit 802.3at Managed PoE Switch (PoE Budget 440W)

PPSW-3100  PLANET FGSW-1816HPS 16-Port 802.3at PoE Switch (PoE Budget 220W)

### Extenders - PoE Extender

PPEX-0100  Veracity OUTREACH Max Power over Ethernet (PoE) Extender

### Extenders - PoE over Coaxial Extender Kit

PPOC-0100  Planet LRP-101C-KIT Power over Coax Adapter Kit

### Audio Devices - Microphone

PMIC-0100  Active Microphone Omnidirectional for all Cameras with Line-in Audio

PMIC-0200  Passive Microphone Omnidirectional for all Cameras with Mic-in Audio using 3.5mm Phone Jack

### Illuminators - IR LED Illuminator

PLED-0200  SPINLUX (SL-A2IRXX10-24CL) IR Illuminator 10° Angle with 120 m approx. range

PLED-0201  SPINLUX (SL-A2IRXX25-24CL) IR Illuminator 25° Angle with 50 m approx. range

PLED-0202  SPINLUX (SL-A2IRXX35-24CL) IR Illuminator 35° Angle with 25 m approx. range

### Product Demo - Camera Demo Kit

PCDK-0001  Camera Demo Kit Rack Box (350 x 550 x 140 mm) for all cameras except Mini Domes