

I27

4MP with D/N, Advanced WDR, SLLS, 30x Zoom Lens



- 4 Megapixel
- Day & Night with Superior Low Light Sensitivity
- 30x Zoom Lens with f4.3-129mm/F1.6-F5.0, DC iris, Auto focus
- Advanced WDR
- Event trigger, response and notification

► Specifications

Device

| | |
|----------------------------------|--|
| Product Type | Zoom Box |
| Maximum Resolution | 4MP |
| Application Environment | Indoor/Outdoor |
| Image Sensor | Progressive Scan CMOS |
| Sensor Size | 1/3 " |
| Effective Pixels | 2688(H) X 1520(V) (4.09 MP) |
| Day / Night | Yes |
| Low Light Sensitivity | Superior |
| Minimum Illumination | Color: 0.1 lux at F1.6 (30 IRE , 2400 K); B/W: 0.05 lux at F1.6 (30 IRE, 2400 K) |
| Color to B/W Switch | ISP based switch, configurable |
| Mechanical IR Cut Filter | Yes |
| IR Sensitivity Range | 700-1100nm |
| IR LED | No |
| Electronic Shutter | 1/5-1/2000 second (manual mode); 1/5-1/10000 second (auto mode) |
| Horizontal Resolution (TV Lines) | 1850 TVL |

S/N Ratio | 56 dB

Lens

| | |
|--------------------------|---|
| Focal Length | Zoom, f4.3-129mm |
| Aperture | F1.6-F5.0 |
| Zoom Ratio | 30x optical |
| Zoom Speed | 2.87 second (wide to tele) |
| Zoom Application | Camera Installation, Auto Zoom by Event, Manual Operation |
| Iris | DC iris |
| Focus | Auto focus |
| Lens Mount | Board mount |
| Horizontal Viewing Angle | 58.9° - 2.11° |
| Vertical Viewing Angle | 40.8° - 1.84° |

PTZ

| | |
|----------------------------|---|
| Absolute Position | Yes |
| Pan, Tilt or Zoom protocol | Visca, Pelco-D, Pelco-P, ACTi URL command |

Video

| | |
|-----------------------------------|---|
| Compression | H.264 (Baseline/ Main/ High profile), MJPEG |
| Maximum Frame Rate vs. Resolution | 15 fps at 2688 x 1520 15 fps at 2560 x 1440 30 fps at 1920 x 1080 30 fps at 1280 x 720 30 fps at 800 x 600 30 fps at 640 x 480 15 fps at 320 x 240 |
| Multi-Streaming | Simultaneous dual streams based on two configurations |
| Bit Rate | 28Kbps - 6Mbps (per stream) |
| Bit Rate Mode | Constant, Variable |
| Wide Dynamic Range | Advanced WDR (75 dB) |
| Image Enhancement | White Balance, Brightness, Contrast, Sharpness, Automatic gain control, Flickerless, Digital Image Stabilizer (DIS, EIS), Defogging |
| Digital Noise Reduction | 2D + 3D DNR |
| Privacy Mask | 32 configurable regions |
| Text Overlay | Yes |
| On-Screen Graphics | Yes |
| Server-based Analytics | Object Line Counting, People Counting, Face Detection, Object Based Motion Detection, Tamper, Object Line Crossing Detection, Object Enter Area Detection, Missing Object Detection, Unattended Object Detection, Smoke Detection, Heat Map, Dwell Time, People Queue Detection, (Require PC-based or standalone IVS or ALPR Server. Contact ACTi support for recommendations on how to maximize analytical accuracy) |
| Image Orientation | Flip, Mirror |

Audio

| | |
|-------------------|--|
| Audio Type | 2-way, Line-in, Line-out |
| Audio Compression | 8 kHz, 16 bit encoding, Mono, PCM, G.711 |

Network

| | |
|----------------------------|---|
| Network Protocol & Service | IPv4/v6, TCP, UDP, DHCP, PPPoE, HTTP, HTTPS, DNS, DDNS, NTP, RTP, RTSP, RTCP, SMTP, FTP, IGMP, ICMP, ARP, Bonjour, UPnP, QoS, SNMP, IEEE 802.1X |
| Ethernet Port | 1 x RJ-45 connector |
| Security | IP address filtering, HTTPS encryption, Password protected user level, Anonymous login, IEEE 802.1X network access control |

Event

| | |
|----------------|---|
| Event Trigger | Video motion detection (3 regions), External device through digital input, Sound detection, |
| Event Response | Notify control center, Go to Zoom preset point or preset tour, Change camera settings, Command other devices, E-mail notification with snapshots, Play the audio file, Push notification to mobile device, Save video to local storage, Upload video or snapshot to FTP server, Upload video to NVR server, Activate external device through digital output |

Integration

| | |
|--------------------------|--|
| Unified Solution | Fully compatible with ACTi software |
| Software Development Kit | Yes |
| GPS Position | Manual setting |
| ONVIF Compliant | Yes, Profile S, Profile G, Profile T* (To be available through future firmware upgrade), Profile Q |
| GB28181 Compliant | Yes |
| Web Browser | IE 11 |
| Auto Firmware Upgrade | Yes |

Interface

| | |
|----------------------|--|
| Serial Port | 1 x RS-485/RS-422 |
| Audio Interface | Terminal block |
| Local Storage | MicroSDHC, MicroSDXC Memory Card Slot (card not included, up to 256GB) |
| Digital Input/Output | 1/1 |
| Operating Button | Reset Button |

General

| | |
|-----------------------|--|
| Power Source | DC 12V, PoE Class 3 (IEEE802.3af) |
| Power Consumption | 6.24 W (PoE), 5.4 W (DC) |
| Weight | 703g (1.55lb) |
| Dimensions | (W x H x D): 81mm x 71mm x 176mm (3.2" x 2.8" x 6.9") |
| Environmental Casing | Optional housing (IP66) |
| Mount Type | Bracket, Pole Mount, Corner Mount |
| Heater | Yes |
| Starting Temperature | -10°C ~ 50°C (14°F ~ 122°F) within 30 minutes |
| Operating Temperature | -20°C ~ 50°C (-4°F ~ 122°F) |
| Operating Humidity | 10% - 85% RH |
| Approvals | CE Class B, FCC Class B, EAC, UL (for optional PoE injector and power adapter) |

| | |
|-----------------------|--|
| Real-time Clock (RTC) | Yes |
| Warranty | 3 Year(s). For extended warranty offering, see http://www.acti.com/support/warranty |

► Photo Indication

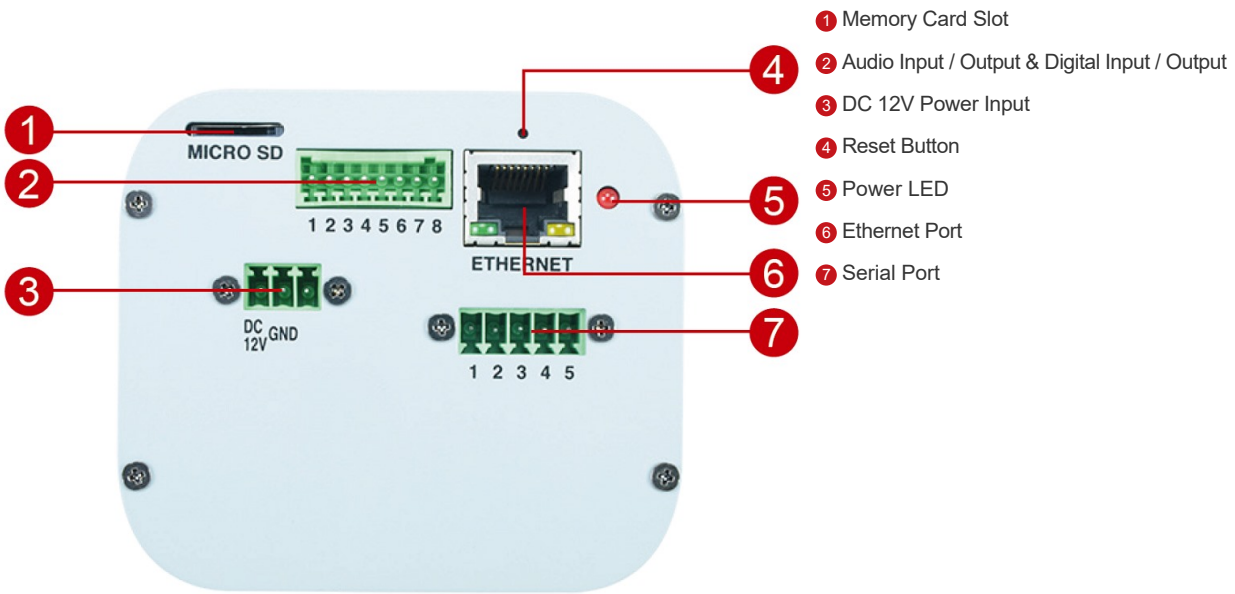



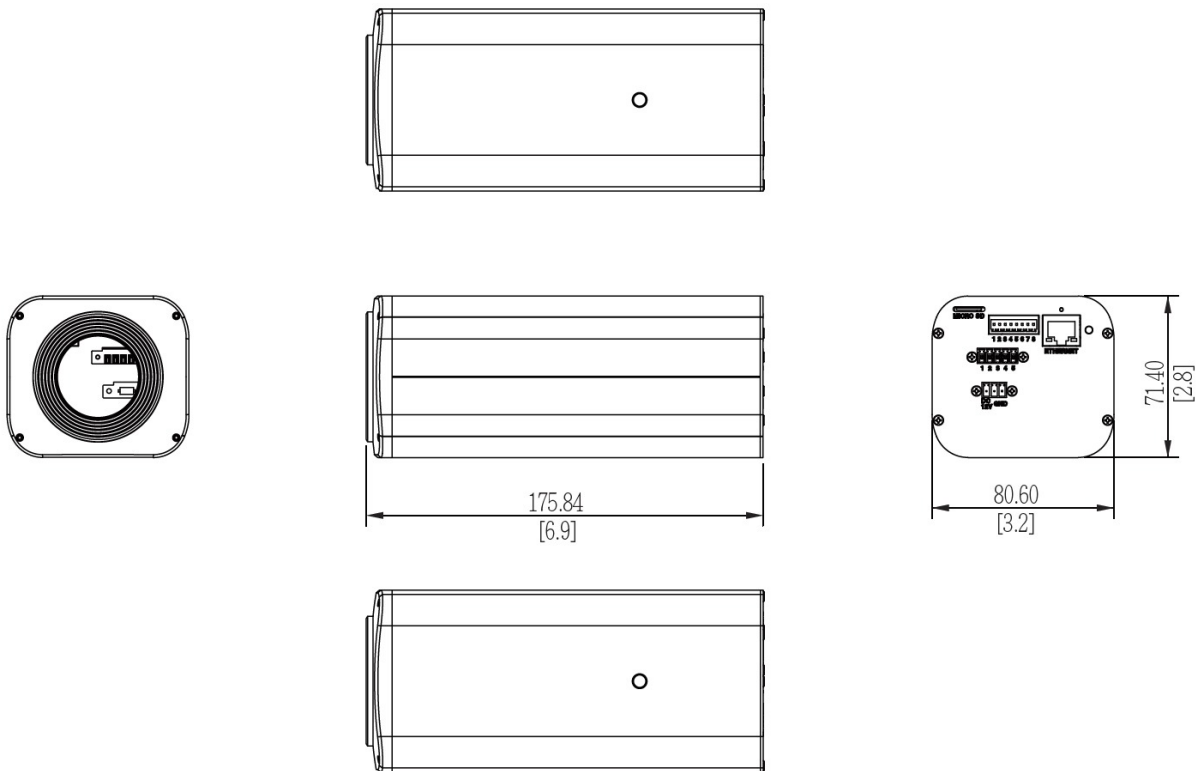



► Dimension Diagram



Unit: mm [inch]









▶ Related Products

Mounting Accessories - Camera Mount

| | | |
|-----------|---|--|
| PMAX-0402 |  | Corner Mount |
| PMAX-0503 |  | Pole Mount (for PMAX-0102, PMAX-0312, PMAX-0313, PMAX-0314, PMAX-0702, PMAX-1106, PMAX-1107), supports 5.25" to 8.5" Poles |
| PMAX-0508 |  | Pole Mount (for PMAX-0203, PMAX-0204, PMAX-0205, PMAX-0206, PMAX-0704), supports 3" to 9" Poles |
| PMAX-0704 |  | Junction Box (for A4x, B4x, B41x, E44, E45, E46, E48, E44A, E45A, E46A, E41x, I4x, PMAX-0203~PMAX-0205) |
| PMAX-1105 |  | Bracket for Indoor Box Cameras (for B2x) |
| PMAX-1106 |  | Bracket for Outdoor Box Cameras (KCM-5211E, KCM-5511, KCM-5611, Box Cameras with Outdoor Housing) |

Note: Some mounting accessories may need additional accessories for installation. Please check www.acti.com/mountingselector for more information.







Enclosures - Box Camera Housing

| | | |
|-----------|---|---|
| PMAX-0200 |  | Outdoor Housing with Heater and Fan (110V) |
| PMAX-0201 |  | Outdoor Housing with Heater and Fan (220V) |
| PMAX-0202 |  | Outdoor Housing |
| PMAX-0203 |  | Heavy Duty Outdoor Housing with Heater and Fan (230V) and Bracket |
| PMAX-0204 |  | Heavy Duty Outdoor Housing with Heater and Fan (110V) and Bracket |
| PMAX-0206 |  | PoE Heavy Duty Outdoor Housing with Heater, Fan, Defogger and Bracket |
| PMAX-0208 |  | Explosion Proof Housing with Heater, Fan (AC 110V~220V) and Bracket |
| PMAX-0210 |  | Stainless Steel Housing with Heater, Fan (AC 110V~220V) and Bracket |

Power Supply Accessories - Power Adapter

| | | |
|-----------|---|--|
| PPBX-0011 |  | Power Adapter AC 100~240V, with universal connectors for all DC12V powered devices |
|-----------|---|--|

Network & Storage Peripherals - Data Switch

| | | |
|-----------|---|--|
| PPSW-0100 |  | PLANET FGSD-910HP 8-Port 802.3at PoE Switch (PoE Budget 120W) |
| PPSW-0101 |  | PLANET GS-4210-8P2T2S 8-Port Gigabit 802.3at Managed PoE Switch (PoE Budget 240W) |
| PPSW-0102 |  | PLANET FGSD-1011HP 8-Port 802.3at PoE Switch (PoE Budget 120W) |
| PPSW-1101 |  | PLANET GS-4210-24PL4C 24-Port Gigabit 802.3at Managed PoE Switch (PoE Budget 440W) |
| PPSW-2101 |  | 4-Port 802.3at PoE Switch (PoE Budget 62W) |
| PPSW-3100 |  | PLANET FGSW-1816HPS 16-Port 802.3at PoE Switch (PoE Budget 220W) |

Extenders - PoE Extender

| | | |
|-----------|---|--|
| PPEX-0100 |  | Veracity OUTREACH Max Power over Ethernet (PoE) Extender |
|-----------|---|--|

Extenders - PoE over Coaxial Extender Kit

| | | |
|-----------|---|---|
| PPOC-0100 |  | Planet LRP-101C-KIT Power over Coax Adapter Kit |
|-----------|---|---|

Audio Devices - Microphone

| | | |
|-----------|---|--|
| PMIC-0100 |  | Active Microphone Omnidirectional for all Cameras with Line-in Audio |
|-----------|---|--|

Illuminators - IR LED Illuminator

| | | |
|-----------|---|--|
| PLED-0200 |  | SPINLUX (SL-A2IRXX10-24CL) IR Illuminator 10° Angle with 120 m approx. range |
| PLED-0201 |  | SPINLUX (SL-A2IRXX25-24CL) IR Illuminator 25° Angle with 50 m approx. range |
| PLED-0202 |  | SPINLUX (SL-A2IRXX35-24CL) IR Illuminator 35° Angle with 25 m approx. range |

Other Accessories - Accessory Part

| | | |
|------------|---|---|
| R707-10000 |  | Mounting Block (for D2x, E2x, B2x, I2x) |
|------------|---|---|

Product Demo - Camera Demo Kit

| | | |
|-----------|---|---|
| PCDK-0001 |  | Camera Demo Kit Rack Box (350 x 550 x 140 mm) for all cameras except Mini Domes |
|-----------|---|---|

Installation Support - Camera Installation Kit

PMON-1001-010



Camera Installation Kit for use with iOS Device with belt bag, battery and charger (US, AC 110~240V)

PMON-1001-011



Camera Installation Kit for use with iOS Device with belt bag, battery and charger (Europe, AC 110~240V)

PMON-2000



Camera Installation Kit