

I98

2MP with D/N, Adaptive IR, Extreme WDR, SLLS, 33x Zoom Lens



- 2 Megapixel
- Day & Night with Superior Low Light Sensitivity and Adaptive IR LED
- 33x Zoom Lens with f4.5-148.5mm/F1.55-F5.0, DC iris, Auto focus
- Extreme WDR
- Endless Pan & Tilt
- PTZ Auto Tracking
- Overview, Zoom and Tracking (OZT)
- Event trigger, response and notification

► Specifications

Device

| | |
|--------------------------|--|
| Product Type | Speed Dome |
| Maximum Resolution | 2MP |
| Application Environment | Outdoor |
| Image Sensor | Progressive Scan CMOS |
| Sensor Size | 1/2.8 " |
| Effective Pixels | 1944(H) X 1224(V) (2.38 MP) |
| Day / Night | Yes |
| Low Light Sensitivity | Superior |
| Minimum Illumination | Color: 0.05 lux at F1.55, B/W: 0 lux at F1.55 (IR LED on) |
| Color to B/W Switch | ISP based switch, configurable |
| Mechanical IR Cut Filter | Yes |
| IR Sensitivity Range | 700-1100nm |
| IR LED | Adaptive IR LED x 8 (850 nm) |
| IR Working Distance | 160m |
| Electronic Shutter | 1/5-1/32000 second (manual mode); 1/5-1/32000 second (auto mode) |

| | |
|----------------------------------|----------|
| Horizontal Resolution (TV Lines) | 1800 TVL |
| S/N Ratio | 56 dB |

Lens

| | |
|--|--|
| Focal Length | Zoom, f4.5-148.5mm |
| Aperture | F1.55-F5.0 |
| Zoom Ratio | 33x optical zoom, 16x digital zoom |
| Zoom Speed | 2.7 second (wide to tele) |
| Zoom Application | Camera Installation, Auto Zoom by Event, Manual Operation |
| Iris | DC iris |
| Focus | Auto focus |
| Lens Mount | Board mount |
| Horizontal Viewing Angle | 69.3° - 3° |
| Vertical Viewing Angle | 38° - 1.7° |
| Overview, Zoom and Tracking (OZT) technology | Yes (Pair of intelligent speed dome camera with B511A, B59A, B74A and B76A hemispheric camera) |

PTZ

| | |
|-----------------------------------|--|
| Scan Panning / Tilting Speed | 0.16° - 32°/second, 0.16° - 16°/second |
| Manual Panning / Tilting Speed | 0.16° - 54.4°/second, 0.16° - 27.2°/second |
| Preset Panning / Tilting Speed | 0.16° - 300°/second, 0.16° - 150°/second |
| Panning Range | 360° endless |
| Tilting Range | -20°~200° |
| PTZ Control | Remote manual control, 256 preset points, 10 preset tours, Auto scan |
| Preset Accuracy (Panning/Tilting) | ±0.265°/±0.265° |
| Absolute Position | Yes |
| Pan, Tilt or Zoom protocol | Visca, Pelco-D, Pelco-P, ACTi URL command |

Video

| | |
|-----------------------------------|---|
| Compression | H.264 (Baseline/ Main/ High profile), MJPEG |
| Maximum Frame Rate vs. Resolution | 60 fps at 1920 x 1080 60 fps at 1280 x 720 30 fps at 640 x 480 30 fps at 320 x 240 |
| High Frame Mode | Support |
| Multi-Streaming | Simultaneous triple streams based on three configurations |
| Bit Rate | 128Kbps - 12Mbps (per stream) |
| Bit Rate Mode | Constant, Variable |
| Wide Dynamic Range | Extreme WDR (145 dB) |
| Image Enhancement | White Balance, Brightness, Contrast, Sharpness, Automatic gain control, Flickerless, Digital Image Stabilizer (DIS, EIS), Defogging |

| | |
|-------------------------|---|
| Digital Noise Reduction | 2D + 3D DNR |
| Privacy Mask | 20 configurable 3D privacy masks |
| Text Overlay | Yes |
| On-Screen Graphics | Yes |
| Built-in Analytics | Basic Face Detection, Object Based Motion Detection, Tampering Detection, Shock Detection, PTZ Auto Tracking, Object Line Crossing Detection, Object Enter Area Detection, Missing Object Detection, Unattended Object Detection, Object Loitering Detection |
| Server-based Analytics | Object Line Counting, People Counting, Face Detection, Object Based Motion Detection, Tamper, Object Line Crossing Detection, Object Enter Area Detection, Missing Object Detection, Unattended Object Detection, Smoke Detection, Heat Map, Dwell Time, Direction Detection, Automatic License Plate Recognition, People Queue Detection, (Require PC-based or standalone IVS or ALPR Server. Contact ACTi support for recommendations on how to maximize analytical accuracy) |
| Image Orientation | Flip, Mirror |
| IVS performance | Certain algorithms may require more computing power, which may limit the number of algorithms that can be concurrently used in the camera. Please test the actual performance before using in a project. |

Audio

| | |
|-------------------|--|
| Audio Type | 2-way, Line-in, Line-out |
| Audio Compression | 8 kHz, 16 bit encoding, Mono, PCM, G.711 |

Network

| | |
|----------------------------|---|
| Network Protocol & Service | IPv4/v6, TCP, UDP, DHCP, PPPoE, HTTP, HTTPS, DNS, DDNS, NTP, RTP, RTSP, RTCP, SMTP, FTP, IGMP, ICMP, ARP, Bonjour, UPnP, QoS, SNMP, IEEE 802.1X |
| Ethernet Port | 1 x RJ-45 pigtail connector |
| Security | IP address filtering, HTTPS encryption, Password protected user level, Anonymous login, IEEE 802.1X network access control |

Video Analytics

| | |
|----------------------|----------|
| Analysis Source Type | Video |
| Metadata Accuracy | Standard |

Event

| | |
|----------------|--|
| Event Trigger | Video motion detection (10 included and excluded polygons regions), External device through digital input, Sound detection, Intelligent event detection, Video streams loss, System log buffer overrun, Remove system log, Logon events (Login Failure, Login Success, Block an Account) |
| Event Response | Notify control center, Go to PTZ preset point or preset tour, Change camera settings, Command other devices, E-mail notification with snapshots, Play the audio file, Push notification to mobile device, Save video to local storage, Upload video to NVR server, Upload video or snapshot to FTP server, Activate external device through digital output |

System

| | |
|------------|---------|
| System Log | Support |
| Watchdog | Support |

Integration

| | |
|------------------|-------------------------------------|
| Unified Solution | Fully compatible with ACTi software |
|------------------|-------------------------------------|

| | |
|--------------------------|---|
| Software Development Kit | Yes |
| GPS Position | Manual setting |
| Edge Recording | Support (integration with NVR by ONVIF Profile G or proprietary protocol)** |
| ONVIF Compliant | Yes, Profile S, Profile G, Profile T, Profile Q |
| GB28181 Compliant | Yes |
| Web Browser | IE 11, Google Chrome*, Microsoft Edge*, Apple Safari* |
| Auto Firmware Upgrade | Yes |

Interface

| | |
|----------------------|--|
| Audio Interface | Cable with 3.5mm Phone Jack |
| Local Storage | MicroSDHC, MicroSDXC Memory Card Slot (card not included, up to 256GB, Kingston or Sandisk only) |
| Digital Input/Output | 4/2 |
| Operating Button | Reset Button |

General

| | |
|-----------------------|--|
| Power Source | AC 24V, High PoE 60W |
| Power Consumption | 50 W (PoE, heater, fan and IR on), 62 W (AC, heater, fan and IR on) |
| Weight | 3112g (6.86lb) |
| Dimensions | (Ø x H): 170mm x 260mm (6.69" x 10.23") |
| Environmental Casing | Weatherproof (IP66), Vandal proof metal casing (IK10), Built-in dehumidifier, Scratch-resistant and water-repellent lens glass |
| Bundled Accessories | High PoE injector (for USA) or Power Adapter (for other countries) |
| Mount Type | Gang Box, Pendant, Converter for NPT Standard Mounts, Wall Mount, Pole Mount, Corner Mount |
| Fan | Yes |
| Heater | Yes |
| Dehumidifier | Yes |
| Starting Temperature | -40°C ~ 55°C (-40°F ~ 131°F) within 30 minutes |
| Operating Temperature | -40°C ~ 55°C (-40°F ~ 131°F) |
| Operating Humidity | 10% - 85% RH |
| Approvals | CE Class B, FCC Class B, EAC, BIS, IP66, NEMA 4X, IK10 (metal casing), UL Listed (UL 60950-1), CNS 16120 (TCA) Level 1 |
| Real-time Clock (RTC) | Yes |
| Warranty | 3 Year(s) (1 year in continuous motion). For extended warranty offering, see http://www.acti.com/support/warranty |

* cross-browser compatibility: Not available for H.265 video decoding ** Edge Recording function is integrated with NVR 3 Corporate / NVR 3 Business / INR / GNR series.

► Photo Indication



- 1 Power LED
- 2 Reset Button
- 3 Memory Card Slot
- 4 Audio Output
- 5 Audio Input
- 6 Digital Input/Output
- 7 AC 24V Power Input
- 8 Ethernet Port



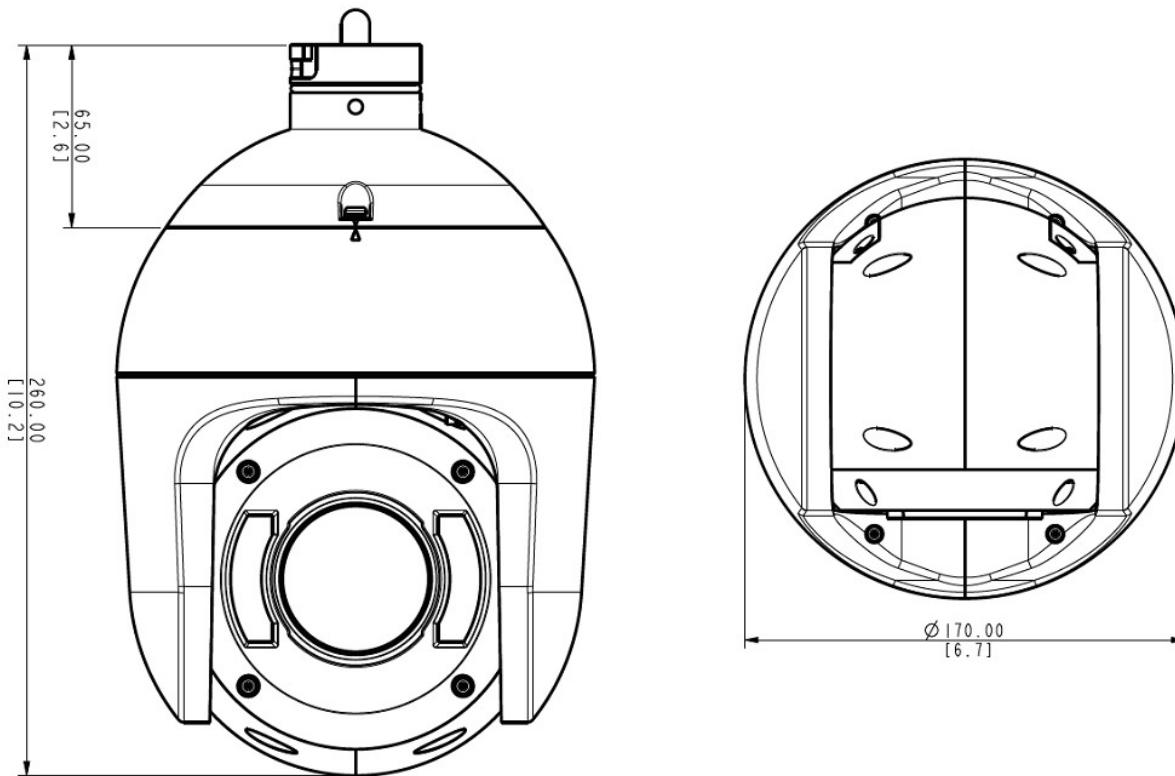









► Dimension Diagram



Unit: mm [inch]

► Related Products

Mounting Accessories - Camera Mount

| | | |
|-----------|--|--|
| PMAX-0102 |  | Straight Tube |
| PMAX-0103 |  | Straight Tube with Bracket |
| PMAX-0104 |  | Extension Tube |
| PMAX-0302 |  | Gooseneck with Bracket |
| PMAX-0303 |  | Gooseneck |
| PMAX-0312 |  | PTZ Wall Mount for Outdoor PTZ / Speed Dome (except KCM-8211 & TCM-6630) |
| PMAX-0402 |  | Corner Mount |
| PMAX-0503 |  | Pole Mount (for PMA-0102, PMA-0312, PMA-0313, PMA-0314, PMA-0702, PMA-1106, PMA-1107), supports 5.25" to 8.5" Poles |
| PMAX-0505 |  | Pole Mount (for B4x, B41x, E44, E45, E46, E48, E44A, E45A, E46A, E41x, I4x, PMA-0312, PMA-0313, PMA-0314, PMA-0330), supports 2" to 3" Poles |
| PMAX-0702 |  | Junction Box for PTZ and Dome Cameras |
| PMAX-0807 |  | Gangbox Converter (for PMA-0102, PMA-0312, PMA-0313, PMA-0314, PMA-0321), supports Two-Gang Boxes |
| PMAX-0808 |  | Converter Ring, 1.5" NPT for Third-Party Mounting Accessories |

Note: Some mounting accessories may need additional accessories for installation. Please check www.acti.com/mountingselector for more information.

Power Supply Accessories - Power Adapter

| | | |
|-----------|---|--|
| PPBX-0005 |  | Power Adapter AC 220V for TCM-6630 |
| PPBX-0008 |  | Power Adapter AC 100~240V, with universal connectors for PLED-0203~PLED-0205 |

Power Supply Accessories - PoE Injector

| | | |
|-----------|---|--|
| PPOE-0102 |  | High PoE Injector (for I93~I910, KCM-8211) , IEEE 802.3at compliant, AC 100~240V, with universal connectors |
| PPOE-0103 |  | High PoE Injector, Single-port, 60W Gigabit Midspan, 4-Pairs, 802.3at Compliant, AC 100~240V, with universal connectors (for, I93~I910, I915, B915~B917, B922, B928, B945, B949, A950, A951) |

PPOE-0104



High PoE Injector, Single-port, 10/100/1000Mbps 60W, 4-Pairs, 802.3at Compliant, AC 100~240V, with universal connectors (for, I93~I910, I915, B915~B917, B922, B928, B945, B949, A950, A951)

Network & Storage Peripherals - Data Switch

PPSW-0100



PLANET FGSD-910HP 8-Port 802.3at PoE Switch (PoE Budget 120W)

PPSW-0102



PLANET FGSD-1011HP 8-Port 802.3at PoE Switch (PoE Budget 120W)

PPSW-0105



PLANET GS-4210-8P2C 8-Port Gigabit 802.3at Managed PoE Switch (PoE Budget 120W)

PPSW-1101



PLANET GS-4210-24PL4C 24-Port Gigabit 802.3at Managed PoE Switch (PoE Budget 440W)

PPSW-2101



4-Port 802.3at PoE Switch (PoE Budget 62W)

PPSW-3100



PLANET FGSW-1816HPS 16-Port 802.3at PoE Switch (PoE Budget 220W)

Extenders - PoE Extender

PPEX-0100



Veracity OUTREACH Max Power over Ethernet (PoE) Extender

Extenders - PoE over Coaxial Extender Kit

PPOC-0100



Planet LRP-101C-KIT Power over Coax Adapter Kit

Audio Devices - Microphone

PMIC-0100



Active Microphone Omnidirectional for all Cameras with Line-in Audio

Illuminators - IR LED Illuminator

PLED-0200



SPINLUX (SL-A2IRXX10-24CL) IR Illuminator 10° Angle with 120 m approx. range

PLED-0201



SPINLUX (SL-A2IRXX25-24CL) IR Illuminator 25° Angle with 50 m approx. range

PLED-0202



SPINLUX (SL-A2IRXX35-24CL) IR Illuminator 35° Angle with 25 m approx. range