

Q51

2MP Heat Map Indoor Hemispheric Dome with D/N, Adaptive IR, Extreme WDR, SLLS, Fixed Lens



- Heat Map
- 2 Megapixel
- Day & Night with Superior Low Light Sensitivity and Adaptive IR LED
- Fisheye Lens with f1.3mm/F2.6
- Extreme WDR
- 360°/180° Panorama View with Dewarped Streaming
- Event trigger, response and notification

► Specifications

Device

Product Type	Hemispheric Dome
Maximum Resolution	2MP
Product Application	Heat Map
Application Environment	Indoor
Image Sensor	Progressive Scan CMOS
Sensor Size	1/1.8 "
Effective Pixels	3096(H) X 2080(V) (6.44 MP)
Day / Night	Yes
Low Light Sensitivity	Superior
Minimum Illumination	Color: 0.1 lux at F2.6 (30 IRE, 2400 K); B/W: 0 lux at F2.6 (IR LED on)
Mechanical IR Cut Filter	Yes
IR Sensitivity Range	700-1100nm
IR LED	Adaptive IR LED x 12 (850 nm)
IR Working Distance	20m
Horizontal Resolution (TV Lines)	1800 TVL

S/N Ratio | 56 dB

Lens

Focal Length	Fixed focal, f1.3mm
Aperture	F2.6
Iris	Fixed iris
Focus	Fixed focus
Lens Mount	Board mount
Horizontal Viewing Angle	171°
Vertical Viewing Angle	115.8°

Video

Compression	H.264 (Baseline/ Main/ High profile), MJPEG
Maximum Frame Rate vs. Resolution	(Dewarped View) 30 fps at 1920 x 1080 30 fps at 1280 x 720 30 fps at 640 x 480 30 fps at 320 x 240
View Mode	Dewarped View
Multi-Streaming	Simultaneous triple streams based on three configurations
Bit Rate	128Kbps - 12Mbps (per stream)
Bit Rate Mode	Constant, Variable
Wide Dynamic Range	Extreme WDR (130 dB)
Image Enhancement	White Balance, Brightness, Contrast, Sharpness, Automatic gain control, Flickerless, Defogging
Digital Noise Reduction	2D + 3D DNR
Text Overlay	Yes
Built-in Analytics	Heat Map, Dwell Time
Server-based Analytics	Object Line Counting, People Counting, Face Detection, Object Based Motion Detection, Tamper, Object Line Crossing Detection, Object Enter Area Detection, Missing Object Detection, Unattended Object Detection, Smoke Detection, Heat Map, Dwell Time, People Queue Detection, (Require PC-based or standalone IVS or ALPR Server. Contact ACTi support for recommendations on how to maximize analytical accuracy)
Image Orientation	Flip, Mirror
IVS performance	Certain algorithms may require more computing power, which may limit the number of algorithms that can be concurrently used in the camera. Please test the actual performance before using in a project.

Audio

Audio Type	2-way, Built-in Microphone, Mic-in, Line-in, Line-out
Audio Compression	8 kHz, 16 bit encoding, Mono, PCM, G.711

Network

Network Protocol & Service	IPv4/v6, TCP, UDP, DHCP, PPPoE, HTTP, HTTPS, DNS, DDNS, NTP, RTP, RTSP, RTCP, SMTP, FTP, IGMP, ICMP, ARP, Bonjour, UPnP, QoS, SNMP, IEEE 802.1X
Ethernet Port	1 x RJ-45 connector

Security	IP address filtering, HTTPS encryption, Password protected user level, Anonymous login, IEEE 802.1X network access control
----------	--

Video Analytics

Analysis Source Type	Video
Metadata Accuracy	Standard

Event

Event Trigger	Scheduler, External device through digital input, Sound detection, System is going to reboot, System booted successfully, Failed to write storage
Event Response	Notify control center, Change camera settings, Command other devices, E-mail notification with snapshots, Play the audio file, Push notification to mobile device, Save video to local storage, Upload video to NVR server, Upload video or snapshot to FTP server, Activate external device through digital output

Integration

Unified Solution	Fully compatible with ACTi software
GPS Position	Manual setting
ONVIF Compliant	Yes, Profile S, Profile G, Profile T* (To be available through future firmware upgrade), Profile Q
Web Browser	IE 11
Auto Firmware Upgrade	Yes* (To be available through future firmware upgrade)

Interface

Local Storage	MicroSDHC, MicroSDXC Memory Card Slot (card not included, up to 256GB, Kingston or Sandisk only)
Digital Input/Output	1/1
Operating Button	Reset Button

General

Power Source	DC 12V, PoE Class 3 (IEEE802.3af)
Power Consumption	7.5 W (PoE), 6 W (DC)
Weight	461g (1.016lb)
Mount Type	Surface, Wall Mount, Ceiling Bracket, Flush, Corner Mount, Pole Mount, Gang Box
Starting Temperature	-10°C ~ 50°C (14°F ~ 122°F)
Operating Temperature	-20°C ~ 50°C (-4°F ~ 122°F)
Approvals	CE Class B, FCC Class B, EAC, UL (for optional PoE injector)
Real-time Clock (RTC)	Yes
Warranty	3 Year(s). For extended warranty offering, see http://www.acti.com/support/warranty

▶ Photo Indication

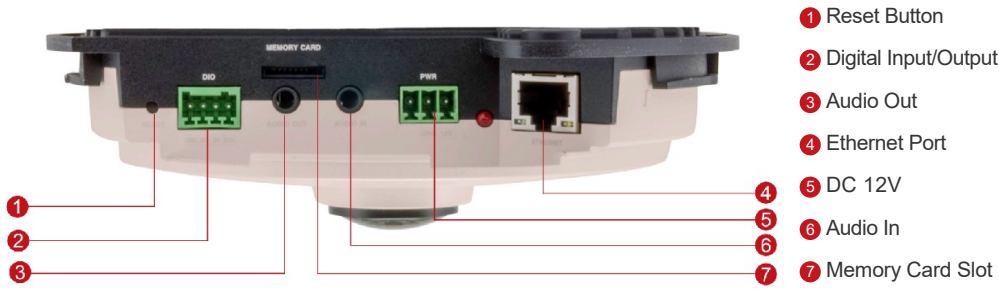



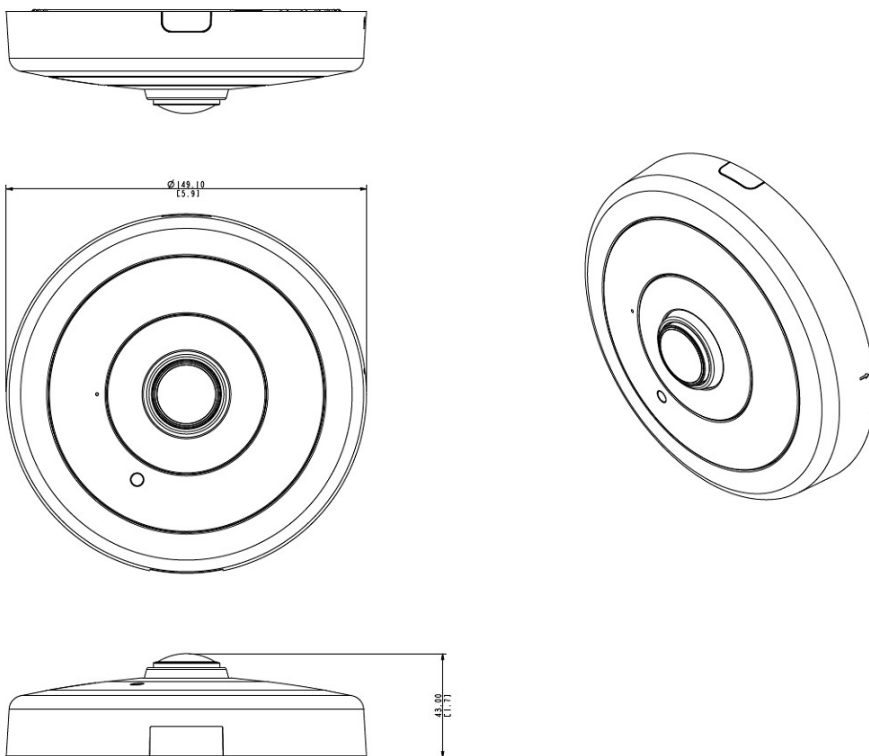











▶ Dimension Diagram



Unit: mm [inch]



▶ Related Products

Mounting Accessories - Camera Mount

PMAX-0101		Mount Kit for all Dome Cameras (except Mini Domes)
PMAX-0102		Straight Tube
PMAX-0103		Straight Tube with Bracket
PMAX-0104		Extension Tube
PMAX-0302		Gooseneck with Bracket
PMAX-0303		Gooseneck
PMAX-0313		Heavy Duty Wall Mount for Indoor Domes (for B5x, B6x, D6x, E6x, I5x)
PMAX-0320		Tilted Wall Mount for Indoor Hemispheric Cameras with IR LED
PMAX-0338		35-Degree Tilted Wall Mount for Fisheye and Hemispheric Cameras
PMAX-0402		Corner Mount
PMAX-0503		Pole Mount (for PMAx-0102, PMAx-0312, PMAx-0313, PMAx-0314, PMAx-0702, PMAx-1106, PMAx-1107), supports 5.25" to 8.5" Poles
PMAX-0702		Junction Box for PTZ and Dome Cameras
PMAX-0804		Gang Box Converter for Outdoor Domes, supports Two-Gang Boxes
PMAX-0808		Converter Ring, 1.5" NPT for Third-Party Mounting Accessories

Note: Some mounting accessories may need additional accessories for installation. Please check www.acti.com/mountingselector for more information.

Network & Storage Peripherals - Data Switch

PPSW-0100		PLANET FGSD-910HP 8-Port 802.3at PoE Switch (PoE Budget 120W)
PPSW-0102		PLANET FGSD-1011HP 8-Port 802.3at PoE Switch (PoE Budget 120W)
PPSW-1101		PLANET GS-4210-24PL4C 24-Port Gigabit 802.3at Managed PoE Switch (PoE Budget 440W)

PPSW-2101  4-Port 802.3at PoE Switch (PoE Budget 62W)

PPSW-3100  PLANET FGSW-1816HPS 16-Port 802.3at PoE Switch (PoE Budget 220W)

Extenders - PoE Extender

PPEX-0100  Veracity OUTREACH Max Power over Ethernet (PoE) Extender

Extenders - PoE over Coaxial Extender Kit

PPOC-0100  Planet LRP-101C-KIT Power over Coax Adapter Kit

Audio Devices - Microphone

PMIC-0100  Active Microphone Omnidirectional for all Cameras with Line-in Audio

PMIC-0200  Passive Microphone Omnidirectional for all Cameras with Mic-in Audio using 3.5mm Phone Jack

Product Demo - Camera Demo Kit

PCDK-0001  Camera Demo Kit Rack Box (350 x 550 x 140 mm) for all cameras except Mini Domes