

# Z75

## 5MP Outdoor Turret with D/N, Adaptive IR, Superior WDR, SLLS, Fixed Lens



- 5 Megapixel
- Day & Night with Superior Low Light Sensitivity and Adaptive IR LED
- Fixed Lens with f2.8mm/F1.6
- Superior WDR
- Super wide angle
- Built-in Analytics
- Event trigger, response and notification

### ► Specifications

#### Device

Product Type	Turret
Maximum Resolution	5MP
Application Environment	Outdoor
Image Sensor	Progressive Scan CMOS
Sensor Size	1/2.7 "
Day / Night	Yes
Low Light Sensitivity	Superior
Minimum Illumination	Color: 0.003 lux at F1.6 (AGC on); B/W: 0 lux (IR LED on)
Mechanical IR Cut Filter	Yes
IR LED	Adaptive IR LED (850 nm)
IR Working Distance	30m
S/N Ratio	75 dB

#### Lens

Focal Length	Fixed focal, f2.8mm
Aperture	F1.6

Iris	Fixed iris
Horizontal Viewing Angle	112.9°
Vertical Viewing Angle	59.1°
Viewing Angle Adjustment	Pan: 0°-360°, Tilt: 0°-90°, Rotation: 0°-360°

## Video

Compression	H.265, H.264 (Baseline/ Main/ High profile), MJPEG
Maximum Frame Rate vs. Resolution	25 fps at 2880 x 1620 25 fps at 2560 x 1440 30 fps at 2304 x 1296 30 fps at 1920 x 1080 30 fps at 1280 x 720 30 fps at 720 x 576 30 fps at 640 x 360
Multi-Streaming	Simultaneous dual streams
Bit Rate	128Kbps - 16Mbps (per stream)
Wide Dynamic Range	Superior WDR (120 dB)
Digital Noise Reduction	2D + 3D DNR
Privacy Mask	4 configurable regions
Built-in Analytics	People Detection, Vehicle Detection, Tampering Detection, Object Line Crossing Detection, Intrusion Detection (Forbidden Area Detection)
Image Orientation	Flip, Mirror, Rotation (Corridor mode)

## Audio

Audio Type	1-way, Built-in Microphone
Audio Compression	G.711

## Network

Network Protocol & Service	TCP, UDP, DHCP, PPPoE, HTTP, HTTPS, DNS, DDNS, NTP, RTP, RTSP, RTCP, SMTP, FTP, IGMP, ICMP, ARP, UPnP, SNMP, QoS, SSL
Ethernet Port	1 x Ethernet (10/100 Base-T), RJ-45 pigtail connector

## Event

Event Trigger	Video motion detection, Sound detection, Intelligent event detection
Event Response	E-mail notification with snapshots, Upload snapshot to FTP server, Save video or snapshot to local storage

## Integration

ONVIF Compliant	Yes, Profile S, Profile G, Profile T
Web Browser	IE 11, Google Chrome, Microsoft Edge, Firefox

## Interface

Local Storage	MicroSD Memory Card Slot (card not included, up to 256GB, Kingston or Sandisk only)
Operating Button	No

## General

Power Source	DC 12V, PoE (IEEE802.3af)
Power Consumption	4.5 W (PoE)
Weight	360g (0.79lb)

Dimensions	(Ø x H): 118mm x 95mm (4.6" x 3.8")
Environmental Casing	Weatherproof (IP68), Vandal proof (IK10)
Mount Type	Wall Mount, Pole Mount, Pendant
Operating Temperature	-30°C ~ 60°C (-22°F ~ 140°F)
Approvals	CE Class B, FCC Class B, IP68, IK10, UL Listed
Color	White
Warranty	2 Year(s). For extended warranty offering, see <a href="http://www.acti.com/support/warranty">http://www.acti.com/support/warranty</a>

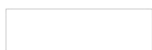

### ► Photo Indication





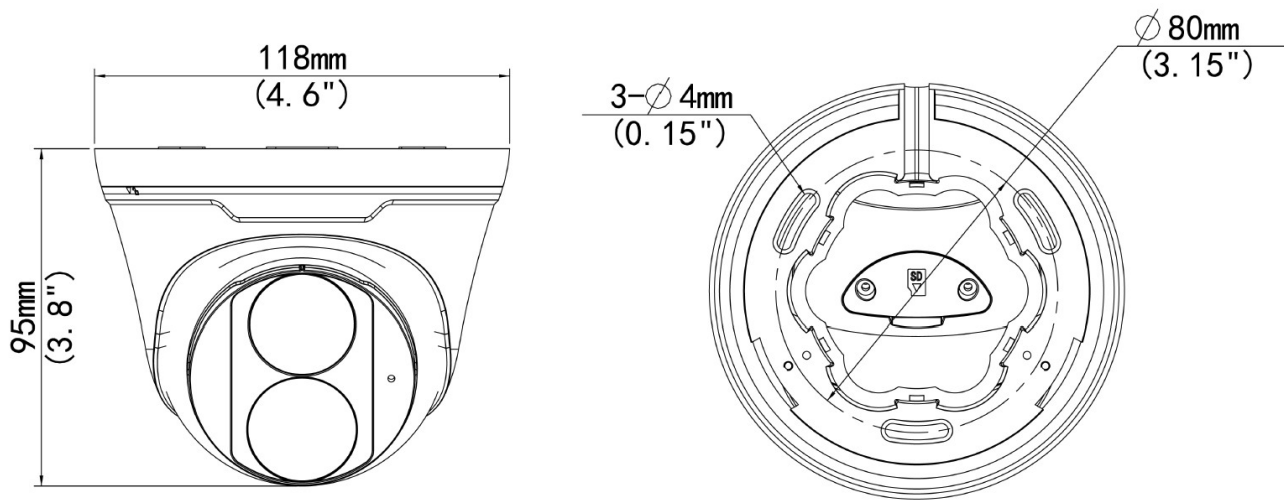

### ► Dimension Diagram



Unit: mm [inch]



## ▶ Related Products

### Mounting Accessories - Camera Mount

PMAX-0128		Pendant Mount (for Z85, Z86, Z87, Z810)
PMAX-0349		Wall Mount with Built-in Junction Box (for Z71, Z72)
PMAX-0527		Pole Mount (for Z4x, Z710, Z8x, Z9x, A7x), supports 2.64" to 5" Poles
PMAX-0532		Pole Mount (Z710, Z8x, Z9x, A7x), supports 2.6" to 5" Poles
PMAX-0727		Junction Box (for Z71, Z72)

**Note:** Some mounting accessories may need additional accessories for installation. Please check [www.acti.com/mountingselector](http://www.acti.com/mountingselector) for more information.

### Power Supply Accessories - Power Adapter

PPBX-0013		Power Adapter AC 100~240V (EU), for A3x, A4x, A88, A9x, Z31, Z8x, Z9x
PPBX-0014		Power Adapter AC 100~240V (UK), for A3x, A4x, A88, A9x, Z31, Z8x, Z9x
PPBX-0026		Power Adapter AC 100~240V (US), for A3x, A4x, A7x, A88, A9x, Z3x, Z4x, Z7x, Z8x, Z9x

### Power Supply Accessories - PoE Injector

PPOE-0107		High PoE Injector IEEE 802.3at compliant, AC 100~240V, with universal connectors (for A416, A418, B913, B923, B934, Q450, Q75, VMGB-60X, Z37, Z71, Z952)
-----------	---	--