

# Z810

## 8MP Outdoor Zoom Dome with D/N, Adaptive IR, Superior WDR, SLLS, 4.3x Zoom Lens



- 8 Megapixel
- Day & Night with Superior Low Light Sensitivity and Adaptive IR LED
- Superior WDR
- H.265 Compression
- Wide Angle

### ► Specifications

#### Device

Product Type	Zoom Dome
Maximum Resolution	8MP
Application Environment	Outdoor
Image Sensor	Progressive Scan CMOS
Sensor Size	1/2.8 "
Day / Night	Yes
Low Light Sensitivity	Superior
Minimum Illumination	Color: 0.003 lux at F1.6 (AGC on); B/W: 0 (IR LED on)
Mechanical IR Cut Filter	Yes
IR LED	Adaptive IR LED x 3 (850 nm)
IR Working Distance	40m
S/N Ratio	56 dB

#### Lens

Focal Length	Zoom, f2.8-12mm
Aperture	F1.6

Zoom Ratio	4.3x optical
Zoom Application	Camera Installation
Focus	Auto focus
Horizontal Viewing Angle	99.8° - 31.1°
Vertical Viewing Angle	53.1° - 17.7°
Viewing Angle Adjustment	Pan: 0°-355°, Tilt: 0°-80°, Rotation: 0°-355°

## Video

Compression	H.265, H.264 (Baseline/ Main/ High profile), MJPEG
Maximum Frame Rate vs. Resolution	20 fps at 3840 x 2160 30 fps at 3072 x 1728 30 fps at 2560 x 1440 30 fps at 1920 x 1080
Multi-Streaming	Simultaneous triple streams
Wide Dynamic Range	Superior WDR (120 dB)
Image Enhancement	Defogging
Digital Noise Reduction	2D + 3D DNR
Built-in Analytics	Tampering Detection, Intrusion Detection (Forbidden Area Detection), Object Line Crossing Detection, Object Enter Area Detection, Object Exit Area Detection, Appear in Area
Image Orientation	Flip, Mirror, Rotation (Corridor mode)

## Audio

Audio Type	2-way, Built-in Microphone, Line-in, Line-out
------------	---

## Integration

ONVIF Compliant	Yes, Profile S, Profile G, Profile T
-----------------	--------------------------------------

## Interface

Local Storage	MicroSD Memory Card Slot (card not included, up to 256GB)
Digital Input/Output	1/1 (Cable with Terminal block)
Operating Button	Reset Button

## General

Power Source	DC 12V, PoE (IEEE802.3af)
Weight	976.5g (2.15lb)
Dimensions	(Ø x H): 148mm x 111.4mm (5.8" x 4.4")
Environmental Casing	Weatherproof (IP68), Vandal proof metal casing (IK10)
Operating Temperature	-30°C ~ 60°C (-22°F ~ 140°F)
Approvals	CE Class B, FCC Class B, IP68, IK10 (metal casing)
Color	White
Material	Metal Plastic
Real-time Clock (RTC)	Yes
Warranty	2 Year(s). For extended warranty offering, see <a href="http://www.acti.com/support/warranty">http://www.acti.com/support/warranty</a>

### ► Photo Indication

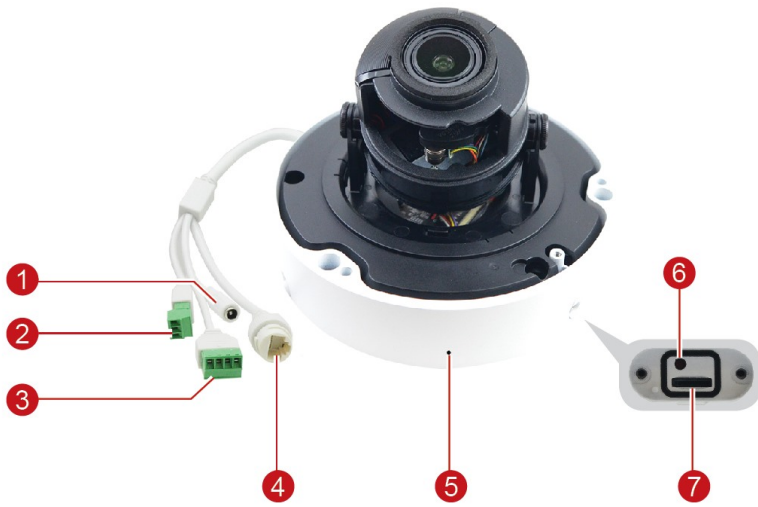

- 1 DC 12V Power Input
- 2 Audio Input / Output
- 3 Digital Input / Output
- 4 Ethernet Port
- 5 Built-in Microphone
- 6 Reset Button
- 7 Memory Card Slot



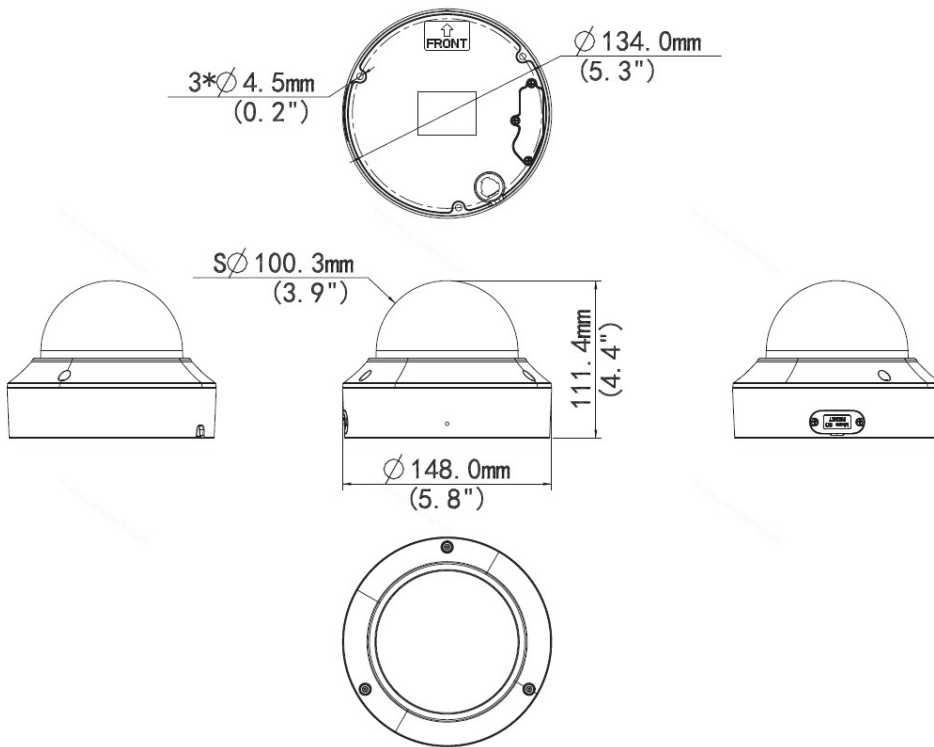







### ► Dimension Diagram



Unit: mm [inch]

## ► Related Products

### Mounting Accessories - Camera Mount

PMAX-0102		Straight Tube
PMAX-0103		Straight Tube with Bracket
PMAX-0104		Extension Tube
PMAX-0127		Mount Kit (for Z83, Z84, A811, A818)
PMAX-0128		Pendant Mount (for Z85, Z86, Z87, Z810)
PMAX-0352		Wall Mount with Built-in Junction Box (for Z83, Z84, Z810)
PMAX-0527		Pole Mount (for Z4x, Z710, Z8x, Z9x, A7x), supports 2.64" to 5" Poles
PMAX-0723		Junction Box (for Z83, Z84)
PMAX-0808		Converter Ring, 1.5" NPT for Third-Party Mounting Accessories
PMAX-1031		Flush Mount (for Z83, Z84)

**Note:** Some mounting accessories may need additional accessories for installation. Please check [www.acti.com/mountingselector](http://www.acti.com/mountingselector) for more information.

### Power Supply Accessories - Power Adapter

PPBX-0012		Power Adapter AC 100~240V (US), for A3x, A4x, A88, A9x, Z31, Z8x, Z9x
PPBX-0013		Power Adapter AC 100~240V (EU), for A3x, A4x, A88, A9x, Z31, Z8x, Z9x
PPBX-0014		Power Adapter AC 100~240V (UK), for A3x, A4x, A88, A9x, Z31, Z8x, Z9x