

Z82

4MP Outdoor Zoom Turret with D/N, Adaptive IR, Extreme WDR, SLLS, 4.4x Zoom Lens



- 4 Megapixel
- Day & Night with Superior Low Light Sensitivity and Adaptive IR LED
- Extreme WDR
- H.265 Compression
- Wide Angle

► Specifications

Device

Product Type	Zoom Turret
Maximum Resolution	4MP
Application Environment	Outdoor
Description	4MP Outdoor Zoom Dome with D/N, Adaptive IR, Extreme WDR, SLLS, 4.4x Zoom lens
Image Sensor	Progressive Scan CMOS
Sensor Size	1/3 "
Day / Night	Yes
Low Light Sensitivity	Superior
Minimum Illumination	Color: 0.02 lux; B/W: 0 lux (IR LED on)
Mechanical IR Cut Filter	Yes
IR LED	Adaptive IR LED
IR Working Distance	30m
S/N Ratio	75 dB

Lens

Focal Length	Zoom, f2.7-12mm
--------------	-----------------

Aperture	F1.4
Zoom Ratio	4.4x optical zoom
Zoom Application	Camera Installation
Focus	Auto focus
Lens Mount	Board mount
Horizontal Viewing Angle	91° - 27°
Vertical Viewing Angle	67.4° - 14.2°
Viewing Angle Adjustment	Pan: 0°-360°, Tilt: 15°-90°, Rotation: 0°-360°

Video

Compression	H.265, H.264 (Baseline/ Main/ High profile), MJPEG
Maximum Frame Rate vs. Resolution	20 fps at 2592 x 1520 25 fps at 2560 x 1440 30 fps at 2048 x 1520 30 fps at 1920 x 1080
Multi-Streaming	Simultaneous triple streams
Wide Dynamic Range	Extreme WDR (120 dB)
Image Enhancement	White Balance, Brightness, Saturation, Contrast, Sharpness, Automatic gain control, Defogging
Digital Noise Reduction	2D + 3D DNR
Privacy Mask	8 configurable regions
Text Overlay	Yes
Built-in Analytics	Tampering Detection
Image Orientation	Flip, Mirror, Rotation (Corridor mode)

Audio

Audio Type	1-way, Built-in Microphone
------------	----------------------------

Network

Network Protocol & Service	IPv4, TCP, UDP, DHCP, HTTP, HTTPS, DNS, DDNS, NTP, RTP, RTSP, RTCP, SMTP, FTP, IGMP, ICMP, ARP, UPnP, QoS, SNMP, IEEE 802.1X
Ethernet Port	1 x Ethernet (10/100 Base-T), RJ-45 pigtail connector

Integration

ONVIF Compliant	Yes, Profile S
Web Browser	IE 11

Interface

Local Storage	MicroSDHC Memory Card Slot (card not included, up to 128GB, Kingston or Sandisk only)
Operating Button	Reset Button

General

Power Source	DC 12V, PoE Class 3 (IEEE802.3af)
Power Consumption	8.16 W (PoE)
Weight	670g (1.48lb)

Dimensions	(Ø x H): 129mm x 110mm (5.08" x 4.3")
Environmental Casing	Weatherproof (IP68), Vandal proof (IK10)
Corrosion Protection	Optional for project request. Chassis corrosion resistance at the seashore approximately 2-3 years.
Operating Temperature	-40°C ~ 60°C (-40°F ~ 140°F)
Approvals	CE, FCC, EAC, IP68, IK10, UL Listed
Real-time Clock (RTC)	Yes
Warranty	2 Year(s). For extended warranty offering, see http://www.acti.com/support/warranty

* Edge Recording function is integrated with NVR 3 Corporate / NVR 3 Business / INR / GNR series. *4 UL certification will be available in Q1 2024.

► Photo Indication



- 1 DC12V Power Input Jack
- 2 Ethernet Port
- 3 Reset Button
- 4 Memory Card Slot



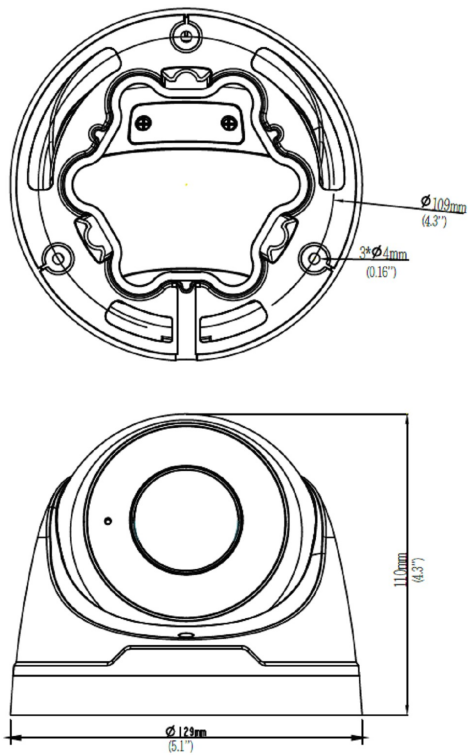

► Dimension Diagram



Unit: mm [inch]

▶ Related Products

Mounting Accessories - Camera Mount

PMAX-0128		Pendant Mount (for Z85, Z86, Z87, Z810)
PMAX-0323		Wall Mount with Built-in Junction Box (for Z91, Z94, Z95,Z97,Z98, Z77, Z81, Z82, Z85, Z86, Z87, A7X)
PMAX-0527		Pole Mount (for Z4x, Z710, Z8x, Z9x, A7x), supports 2.64" to 5" Poles
PMAX-0532		Pole Mount (Z710, Z8x, Z9x, A7x), supports 2.6" to 5" Poles
PMAX-0713		Junction box / Mount Kit (for Z81, Z82, Z85, Z86, Z87, Z812, Z813, Z814)

Note: Some mounting accessories may need additional accessories for installation. Please check www.acti.com/mountingselector for more information.

Power Supply Accessories - Power Adapter

PPBX-0013		Power Adapter AC 100~240V (EU), for A3x, A4x, A88, A9x, Z31, Z8x, Z9x
PPBX-0014		Power Adapter AC 100~240V (UK), for A3x, A4x, A88, A9x, Z31, Z8x, Z9x
PPBX-0026		Power Adapter AC 100~240V (US), for A3x, A4x, A7x, A88, A9x, Z3x, Z4x, Z7x, Z8x, Z9x

Power Supply Accessories - PoE Injector

PPOE-0107		High PoE Injector IEEE 802.3at compliant, AC 100~240V, with universal connectors (for A416, A418, B913, B923, B934, Q450, Q75, VMGB-60X, Z37, Z71, Z952)
-----------	---	--