

Z86

4MP Outdoor Zoom Dome with D/N, Adaptive IR, Superior WDR, SLLS, 4.3x Zoom Lens



- 4 Megapixel
- Day & Night with Superior Low Light Sensitivity and Adaptive IR LED
- 4.3x Zoom Lens with f2.8-12/F1.6, Auto focus (for installation)
- Superior WDR
- H.265 Compression
- Super wide angle
- Built-in Analytics
- Event trigger, response and notification

► Specifications

Device

Product Type	Zoom Dome
Maximum Resolution	4MP
Application Environment	Outdoor
Image Sensor	Progressive Scan CMOS
Sensor Size	1/3 "
Day / Night	Yes
Low Light Sensitivity	Superior
Minimum Illumination	Color: 0.003 lux at F1.6 (AGC on); BW: 0 (AGC on)
Mechanical IR Cut Filter	Yes
IR LED	Adaptive IR LED x 2 (850 nm)
IR Working Distance	40m
Electronic Shutter	1-1/100000 second (manual mode); 1-1/100000 second (auto mode)
S/N Ratio	56 dB

Lens

Focal Length	Zoom, f2.8-12mm
--------------	-----------------

Aperture	F1.6
Zoom Ratio	4.3x optical
Zoom Application	Camera Installation
Iris	Fixed iris
Focus	Auto focus
Lens Mount	Board mount
Horizontal Viewing Angle	102.1° - 30.7°
Vertical Viewing Angle	54.5° - 16.9°
Viewing Angle Adjustment	Pan: 3°-360°, Tilt: 0°-70°, Rotation: 0°-360°

Video

Compression	H.265, H.264 (Baseline/ Main/ High profile), MJPEG
Maximum Frame Rate vs. Resolution	25 fps at 2688 x 1520 25 fps at 2560 x 1440 30 fps at 2304 x 1296 30 fps at 1920 x 1080 30 fps at 1280 x 720 30 fps at 720 x 576 30 fps at 704 x 288 30 fps at 640 x 360 30 fps at 352 x 288
Multi-Streaming	Simultaneous dual streams
Wide Dynamic Range	Superior WDR (120 dB)
Image Enhancement	Wide Dynamic Range, Backlight compensation (BLC), Brightness, Contrast, Sharpness, Automatic gain control, Defogging
Digital Noise Reduction	2D + 3D DNR
Privacy Mask	4 configurable regions
Text Overlay	Yes
Built-in Analytics	Tampering Detection, Object Line Crossing Detection, Intrusion Detection (Forbidden Area Detection)
Image Orientation	Flip, Mirror, Rotation (Corridor mode)

Audio

Audio Type	1-way, Built-in Microphone
Audio Compression	G.711

Network

Network Protocol & Service	IPv4, TCP, UDP, DHCP, PPPoE, HTTP, HTTPS, DNS, DDNS, NTP, RTP, RTSP, RTCP, SMTP, FTP, IGMP, ICMP, ARP, UPnP, SSL, SNMP
Ethernet Port	1 x Ethernet (10/100 Base-T), RJ-45 connector
Security	IP address filtering, HTTPS encryption, Password protected user level

Event

Event Trigger	Video motion detection (4 regions) Sound detection Intelligent event detection
Event Response	E-mail notification with snapshots, Upload snapshot to FTP server

Integration

ONVIF Compliant	Yes, Profile S, Profile G, Profile T
Web Browser	IE 11

Interface

Local Storage	MicroSD Memory Card Slot (card not included, up to 256GB)
Operating Button	Reset Button

General

Power Source	DC 12V, PoE (IEEE802.3af)
Power Consumption	7.5 W (PoE)
Weight	775g (1.71lb)
Dimensions	(Ø): 128mm x 100mm (5.0" x 3.9")
Environmental Casing	Weatherproof (IP67), Vandal proof metal casing (IK10)
Operating Temperature	-30°C ~ 60°C (-22°F ~ 140°F)
Operating Humidity	10% - 95% RH
Approvals	CE Class B, FCC Class B, IP68, IK10 (metal casing)
Material	Camera body: Metal Dome Cover: Plastic
Real-time Clock (RTC)	No
Warranty	2 Year(s). For extended warranty offering, see http://www.acti.com/support/warranty

► Photo Indication





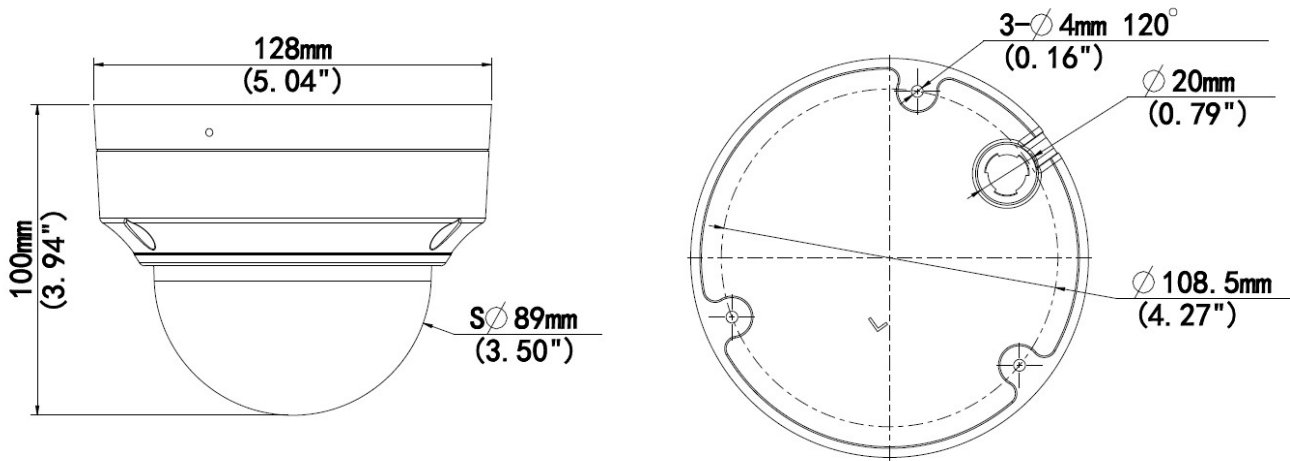

► Dimension Diagram



Unit: mm [inch]

▶ Related Products

Mounting Accessories - Camera Mount

PMAX-0128		Pendant Mount (for Z85, Z86, Z87, Z810)
PMAX-0323		Wall Mount with Built-in Junction Box (for Z91, Z94, Z95, Z77, Z81, Z82, Z85, Z86)
PMAX-0527		Pole Mount (for Z4x, Z710, Z8x, Z9x, A7x), supports 2.64" to 5" Poles
PMAX-0532		Pole Mount (Z710, Z8x, Z9x, A7x), supports 2.6" to 5" Poles
PMAX-0713		Junction box (for Z81, Z82)

Note: Some mounting accessories may need additional accessories for installation. Please check www.acti.com/mountingselector for more information.