

Z91

4MP Outdoor Mini Dome with D/N, Adaptive IR, Extreme WDR, SLLS, Fixed Lens



- 4 Megapixel
- Day & Night with Superior Low Light Sensitivity and Adaptive IR LED
- Fixed Lens, f2.8mm/F2.0
- Extreme WDR
- H.265 Compression
- Super wide angle
- Event trigger, response and notification

► Specifications

Device

Product Type	Mini Dome
Maximum Resolution	4MP
Application Environment	Outdoor
Image Sensor	Progressive Scan CMOS
Sensor Size	1/3 "
Effective Pixels	2688(H) X 1520(V) (4.09 MP)
Day / Night	Yes
Low Light Sensitivity	Superior
Minimum Illumination	Color: 0.02 lux; B/W: 0 lux (IR LED on)
Color to B/W Switch	ISP based switch, configurable
Mechanical IR Cut Filter	Yes
IR LED	Adaptive IR LED
IR Working Distance	30m
Electronic Shutter	1/6-1/100000 second (manual mode); 1/6-1/100000 second (auto mode)
S/N Ratio	55 dB

Lens	
Focal Length	Fixed focal, f2.8mm
Aperture	F2.0
Iris	Fixed iris
Focus	Fixed focus
Lens Mount	Board mount
Horizontal Viewing Angle	101.8°
Vertical Viewing Angle	46.9°
Viewing Angle Adjustment	Pan: ±175°, Tilt: 0°-90°, Rotation: ±175°

Video	
Compression	H.265, H.264, MJPEG
Maximum Frame Rate vs. Resolution	20 fps at 2592 x 1520 25 fps at 2560 x 1440 30 fps at 2048 x 1520 30 fps at 1920 x 1080
Multi-Streaming	Simultaneous triple streams based on configurations of video resolution, compression format, and frame rate
Wide Dynamic Range	Extreme WDR (120 dB)
Image Enhancement	Defogging
Digital Noise Reduction	2D + 3D DNR
Privacy Mask	8 configurable regions
Built-in Analytics	Tampering Detection
Image Orientation	Flip, Mirror, Rotation (Corridor mode)

Audio	
Audio Type	2-way, Mic-in, Line-in, Line-out
Audio Compression	G.711

Network	
Ethernet Port	1 x RJ-45 pigtail connector

Event	
Event Trigger	Video motion detection, External device through digital input, Sound detection, Tampering detection
Event Response	E-mail notification with snapshots, Save video to storage, Upload snapshot to FTP server, Activate external device through digital output

Integration	
ONVIF Compliant	Yes, Profile S

Interface	
Audio Interface	1/1, Audio cable
Digital Input/Output	1/1 (Cable without connector)

General	
Power Source	DC 12V, PoE Class 3 (IEEE802.3af)

Power Consumption	5.5 W (PoE)
Weight	450g (0.99lb)
Dimensions	(\varnothing x H): 108.5mm x 81mm (4.28" x 3.2")
Environmental Casing	Weatherproof (IP67), Vandal proof (IK10)
Mount Type	Surface, Wall Mount, Pendant, Pole Mount
Operating Temperature	-35°C ~ 60°C (-31°F ~ 140°F)
Approvals	CE, FCC, IP67, IK10, UL Listed
Real-time Clock (RTC)	Yes
Warranty	2 Year(s). For extended warranty offering, see http://www.acti.com/support/warranty



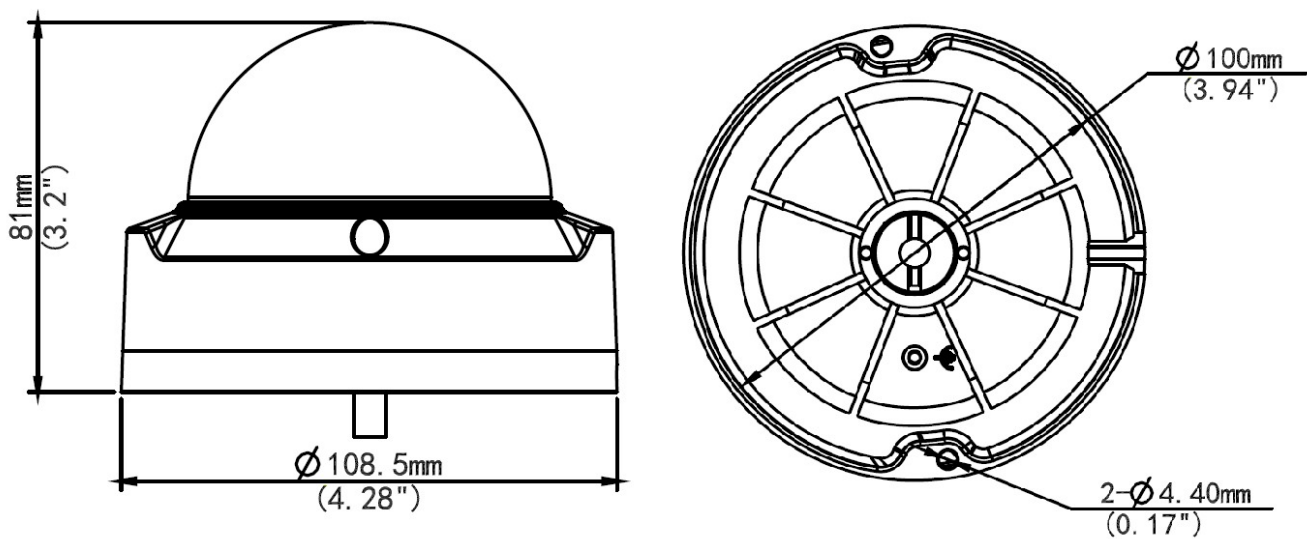

► Dimension Diagram







Unit: mm [inch]

► Related Products

Mounting Accessories - Camera Mount

PMAX-0122		Straight Tube (for A71, A88, A9x,)
PMAX-0123		Extension Tube (for A71, A88, A9x,)
PMAX-0318		Wall Mount (for Z91, Z97, Z98, Z710, Z714, Z715, A71, A76, A77)
PMAX-0323		Wall Mount with Built-in Junction Box (for Z91, Z94, Z95, Z97, Z98, Z77, Z81, Z82, Z85, Z86, Z87, A7X)

PMAX-0506		Pole Mount (for A31, A4x, E78, E9x, E9xx), supports 2" to 3" Poles
PMAX-0712		Junction box (for Z91, Z92, Z94, Z95, Z97, Z98, Z714, Z77)
PMAX-0816		Converter Ring, 1.0" NPT for Third-Party Mounting Accessories, White
PMAX-0820		Gang Box Converter (for A71, A74, Z91, Z94, Z95), supports 4" Round and 4" Octagon Boxes
PMAX-1402		Mount Kit (for Z91, Z97, Z98, Z710, Z714, Z715, A71, A76, A77)

Note: Some mounting accessories may need additional accessories for installation. Please check www.acti.com/mountingselector for more information.

Power Supply Accessories - Power Adapter

PPBX-0013		Power Adapter AC 100~240V (EU), for A3x, A4x, A88, A9x, Z31, Z8x, Z9x
PPBX-0014		Power Adapter AC 100~240V (UK), for A3x, A4x, A88, A9x, Z31, Z8x, Z9x

Audio Devices - Microphone

PMIC-0100		Active Microphone Omnidirectional for all Cameras with Line-in Audio
-----------	-----------------------------------------------------------------------------------	----------------------------------------------------------------------

