



Box Camera Series Hardware Manual

D21FA, D21VA, D22FA, D22VA
E21FA, E21VA, E22FA, E22VA
E23A, E23B, E24A, E25A
E217, E222, E270, E271

2015/10/05



ACTi
Connecting Vision

Table of Contents

Precautions 4

Safety Instructions	6
---------------------------	---

Introduction..... 7

The List of Models	7
Package Contents.....	9
Physical Description	10
D2xFA / E2xFA / E270.....	10
D2xVA / E2xVA / E23A / E24A / E25A / E271	10
E23B	12
E217	14
E222	14
Mounting Options	16

Indoor Installation Procedures 17

Step 1: Attach the Camera Lens.....	17
Step 2: Attach the Mounting Block.....	19
Step 3: Mount the Indoor Bracket	20
Step 4: Attach the Camera to the Bracket	20
Step 5: Connect the Cable(s).....	23
Step 6: Access the Camera Live View.....	24
Step 7: Adjust the Viewing Angle and Focus	24

Other Connections (Optional)..... 25

How to Connect DI/DO and Audio Devices.....	25
How to Connect DI/DO Devices	25
DI/DO Connection Specifications.....	26

How to Connect Audio Devices 29

How to Connect a Power Adapter (for E217, E222 only) 30

How to Connect a Serial Device (for E23B, E217, E222 only) 32

Other Adjustments and Accessories 34

How to Adjust the Viewing Angle and Focus 34

 D21FA / E21FA 34

 D22FA / E22FA / E217 / E270 34

 D2xVA / E2xVA / E23A / E23B / E24A / E25A / E222 / E271 35

How to Install / Remove the Memory Card 36

 How to Insert the Memory Card 36

 How to Remove the Memory Card 36

How to Replace the Lens 37

Accessing the Camera 39

Configure the IP Addresses 39

Access the Camera 43

Precautions

Read these instructions

You should read all the safety and operating instructions before using this product.

Heed all warnings

You must adhere to all the warnings on the product and in the instruction manual. Failure to follow the safety instruction given may directly endanger people, cause damage to the system or to other equipment.

Servicing

Do not attempt to service this video device yourself as opening or removing covers may expose you to dangerous voltage or other hazards. Refer all servicing to qualified service personnel.

Trademarks

All names used in this manual are probably registered trademarks of respective companies.

Liability

Every reasonable care has been taken during the writing of this manual. Please inform your local office if you find any inaccuracies or omissions. We cannot be held responsible for any typographical or technical errors and reserve the right to make changes to the product and manuals without prior notice.

Federal Communications Commission Statement



This equipment has been tested and found to comply with the limits for a class B digital device, pursuant to Part 15 of the FCC Rules. These limits are designed to provide reasonable protection against harmful interference in a residential installation. This equipment generates, uses, and can radiate radio frequency energy and, if not installed and used in accordance with the instructions, may cause harmful interference to radio communications. However, there is no guarantee that interference will not occur in a particular installation. If this equipment does cause harmful interference to radio or television reception, which can be determined by turning the equipment off and on, the user is encouraged to try to correct the interference by one or more of the following measures:

- Reorient or relocate the receiving antenna.
- Increase the separation between the equipment and receiver.
- Connect the equipment into an outlet on a circuit different from that to which the receiver is connected.
- Consult the dealer or an experienced radio/TV technician for help.

Warning: Changes or modifications to the equipment that are not expressly approved by the responsible party for compliance could void the user's authority to operate the equipment.

European Community Compliance Statement



This product has been tested and found to comply with the limits for Class B Information Technology Equipment according to European Standard EN 55022 and EN 55024. In a domestic environment, this product may cause radio interference in which cause the user may be required to take adequate measures.

Safety Instructions

Cleaning

Disconnect this video product from the power supply before cleaning.

Attachments

Do not use attachments not recommended by the video product manufacturer as they may cause hazards.

Installation

Install this device as well as other devices (such as PoE injector, alarm, etc.) in a dry place protected from weather.

Servicing

Do not attempt to service this video product yourself. Refer all servicing to qualified service personnel.

Damage Requiring service

Disconnect this video product from the power supply immediately and refer servicing to qualified service personnel under the following conditions.

- 1) When the power-supply cord or plug is damaged
- 2) If liquid has been spilled, or objects have fallen into the video product.
- 3) If the inner parts of video product have been directly exposed to rain or water.
- 4) If the video product does not operate normally by following the operating Instructions in this manual. Adjust only those controls that are covered by the instruction manual, as an improper adjustment of other controls may result in damage, and will often require extensive work by a qualified technician to restore the video product to its normal operation.











Safety Check





Upon completion of any service or repairs to this video product, ask the service technician to perform safety checks to determine if the video product is in proper operating condition.

Introduction

The List of Models

This hardware manual contains the following models:

D21FA		1MP Box with D/N, Fixed lens
D21VA		1MP Box with D/N, Vari-focal lens
D22FA		5MP Box with D/N, Fixed lens
D22VA		5MP Box with D/N, Vari-focal lens
E21FA		1MP Box with D/N, Basic WDR, Fixed lens
E21VA		1MP Box with D/N, Basic WDR, Vari-focal lens
E22FA		5MP Box with D/N, Basic WDR, Fixed lens
E22VA		5MP Box with D/N, Basic WDR, Vari-focal lens
E23A		2MP Box with D/N, Basic WDR, SLLS, Vari-focal lens
E23B		2MP Box with D/N, Basic WDR, SLLS, Vari-focal lens
E24A		3MP Box with D/N, Superior WDR, Vari-focal lens

E25A		1.3MP Box with D/N, Basic WDR, SLLS, Vari-focal lens
E217		2MP Video Analytics Box with D/N, Extreme WDR, SLLS, Fixed lens
E222		2MP Box with D/N, Extreme WDR, SLLS, Vari-focal lens
E270		10MP Box with D/N, Basic WDR, Fixed lens
E271		10MP Box with D/N, Basic WDR, Vari-focal lens

From the installation perspective, these models are very similar; therefore one manual is used for all of them.

Package Contents

Camera	Lens (D2xFA / E2xFA / E217 / E270)	Lens (D2xVA / E2xVA / E2xA / E23B / E222 / E271)
	 <p>Fixed focal lens with manual focus and fixed iris</p>	 <p>Vari-focal lens with manual focus and DC iris</p>
Mounting Block with Screws	Audio and DI/DO Terminal Block	Serial Port Terminal Block (for E23B only)
		
Power Terminal Block (for E217 & E222 only)	Quick Installation Guide	Warranty Card
		

NOTE: The pictures are for reference only, actual items may slightly vary in appearance.

Physical Description

D2xFA / E2xFA / E270



D2xVA / E2xVA / E23A / E24A / E25A / E271



1) Ethernet Port

Connects to a network using an Ethernet cable.

2) Memory Card Slot

Insert a memory card into this slot for local recording purposes. See [How to Install / Remove the Memory Card](#) on page 36 for more information.

NOTE: Supports microSDHC and microSDXC cards.

3) Reset Button

The purpose of reset button is to restore the factory default settings of the camera, including administrator's password.

The reset button can be used for following purposes:

1. The administrator's password has been forgotten and therefore the camera cannot be accessed.
2. In case of IP address, mask, or allow/deny filter related issues, resulting with inability to modify these settings.
3. In case of connectivity issues or abnormal video quality.

How to do the reset?

Using a pointed object, such as a paper clip, press and hold the reset button for at least 5 seconds or until the Power LED goes off.

4) Power LED

The Power LED turns on when the camera is powered on and the system is running.

5) Digital Input / Output (DI/DO) and Audio Input / Output

This connector connects to digital input or output devices, such as an alarm trigger, panic button, etc., as well as audio input and output devices, such as microphones and speakers. Digital Input (DI) and Digital Output (DO) devices are used in applications like motion detection, event triggering, alarm notifications, etc. See [How to Connect DI/DO and Audio Devices](#) on page 25 for more information.

6) DC Iris Port

When a DC iris lens is used, connect the lens cable to this port.

E23B



1) Serial Port

This port connects to serial devices via RS-485 or RS-422 protocols. Use the supplied serial port terminal block to connect the wires from the serial device to the camera.

See [How to Connect a Serial Device \(for E23B, E217, E222 only\)](#) on page 32 for connection details.

2) Ethernet Port

Connects to a network using an Ethernet cable.

3) Memory Card Slot

Insert a memory card into this slot for local recording purposes. See [How to Install / Remove the Memory Card](#) on page 36 for more information.

NOTE: Supports microSDHC and microSDXC cards.

4) Reset Button

The purpose of reset button is to restore the factory default settings of the camera, including administrator's password.

The reset button can be used for following purposes:

1. The administrator's password has been forgotten and therefore the camera cannot be accessed.
2. In case of IP address, mask, or allow/deny filter related issues, resulting with inability to modify these settings.
3. In case of connectivity issues or abnormal video quality.

How to do the reset?

Using a pointed object, such as a paper clip, press and hold the reset button for at least 5 seconds or until the Power LED goes off.

5) Power LED

The Power LED turns on when the camera is powered on and the system is running.

6) Digital Input / Output (DI/DO) and Audio Input / Output

This connector connects to digital input or output devices, such as an alarm trigger, panic button, etc., as well as audio input and output devices, such as microphones and speakers. Digital Input (DI) and Digital Output (DO) devices are used in applications like motion detection, event triggering, alarm notifications, etc. See [How to Connect DI/DO and Audio Devices](#) on page 25 for more information.

7) DC Iris Port

When a DC iris lens is used, connect the lens cable to this port.

E217



E222



1) Serial Port

This port connects to serial devices via RS-485 or RS-422 protocols. Use the supplied serial port terminal block to connect the wires from the serial device to the camera.

See [How to Connect a Serial Device \(for E23B, E217, E222 only\)](#) on page 32 for connection details.

2) Ethernet Port

Connects to a network using an Ethernet cable.

3) Memory Card Slot

Insert a memory card into this slot for local recording purposes. See [How to Install / Remove the Memory Card](#) on page 36 for more information.

NOTE: Supports microSDHC and microSDXC cards.

4) Reset Button

The purpose of reset button is to restore the factory default settings of the camera, including administrator's password.

The reset button can be used for following purposes:

1. The administrator's password has been forgotten and therefore the camera cannot be accessed.
2. In case of IP address, mask, or allow/deny filter related issues, resulting with inability to modify these settings.
3. In case of connectivity issues or abnormal video quality.

How to do the reset?

Using a pointed object, such as a paper clip, press and hold the reset button for at least 5 seconds or until the Power LED goes off.

5) Power LED

The Power LED turns on when the camera is powered on and the system is running.

6) Digital Input / Output (DI/DO) and Audio Input / Output

This connector connects to digital input or output devices, such as an alarm trigger, panic button, etc., as well as audio input and output devices, such as microphones and speakers. Digital Input (DI) and Digital Output (DO) devices are used in applications like motion detection, event triggering, alarm notifications, etc. See [How to Connect DI/DO and Audio Devices](#) on page 25 for more information.

7) DC 12V Power Input

In case the camera is connected to a non-PoE (Power over Ethernet) switch, use this connector to connect the camera to an external power adapter (not included). See [How to Connect a Power Adapter \(for E217, E222 only\)](#) on page 30 for more information.

8) DC Iris Port

When a DC iris lens is used, connect the lens cable to this port.

Mounting Options

The camera can be installed both indoors and outdoors. For outdoor installation, additional waterproof housing is required. Below are several mounting options that you can use to install the camera. Select the most suitable solution for your installation environment.

Mount Types	Accessories
Ceiling or Wall (Indoor)	The camera comes with a mounting block which is used to mount an additional bracket to complete the installation. The additional bracket is not included in the camera package. You may use the bracket from a local supplier or purchase ACTi's indoor bracket. See Indoor Installation Procedures on page 17 for more information.
	PMAX-1104 
Wall (Outdoor)	A waterproof housing is required when installing the camera outdoors.
Pole Mount	Suitable when mounting the camera on vertical poles. The camera must be enclosed inside the waterproof housing.
Corner Mount	Suitable when mounting the camera on a corner wall. The camera must be enclosed inside the waterproof housing.

NOTE:

- For more information about the mounting solutions and accessories, please check the [Mounting Accessory Selector](http://www.acti.com/mountingselector) in our website (<http://www.acti.com/mountingselector>).
- The above mounting accessories are not included in the package. Contact your sales agents to purchase.

Indoor Installation Procedures

This section describes the procedures in installing the camera indoors using PMAX-1104 indoor bracket (purchased separately).

When using brackets from other manufacturers, check the installation guide included in the bracket to install the camera. Similar procedures apply when using brackets from other camera manufacturers.

NOTE: Some pictures in this documentation only show one type of camera lens; this means that the procedures are applicable to other types of lens, unless specified otherwise.

Step 1: Attach the Camera Lens

NOTE: To avoid scratches or leaving fingerprints on the lens, it is recommended to retain the protective cap covering the lens until the camera is completely installed.

1. Unpack the camera and check the bundled camera lens. The camera comes with one of the following lens.



2. Pull to remove the cap covering the camera lens holder.



3. Twist and pull to remove the cap covering the threaded end of the lens.



4. Attach the lens to the camera.

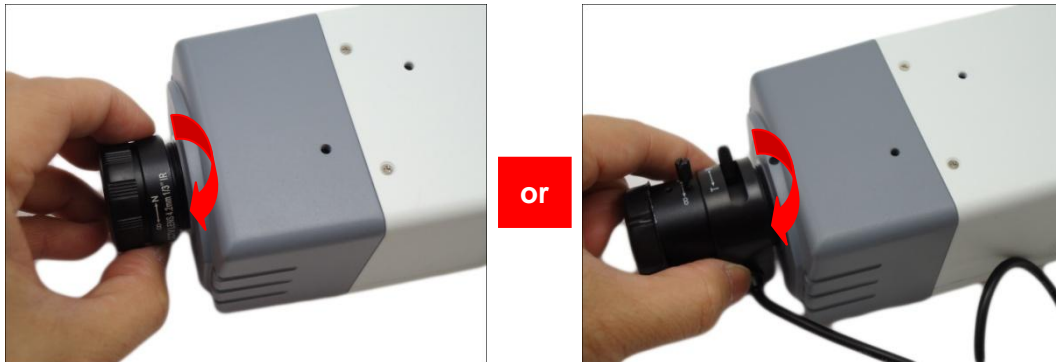

5. For cameras models D2xVA, E2xVA, E2xA, E23B, E222, and E271, connect the lens cable to the DC-iris port.



Step 2: Attach the Mounting Block

Determine where you want to install the camera: **on the ceiling** or **on the wall**.

- **If the camera will be installed on the ceiling**, attach the mounting block on the top side of the camera.



- **If the camera will be installed on the wall**, attach the mounting block on the bottom side of the camera. Secure the mounting block to the camera using the two (2) screws included in the mounting block package.

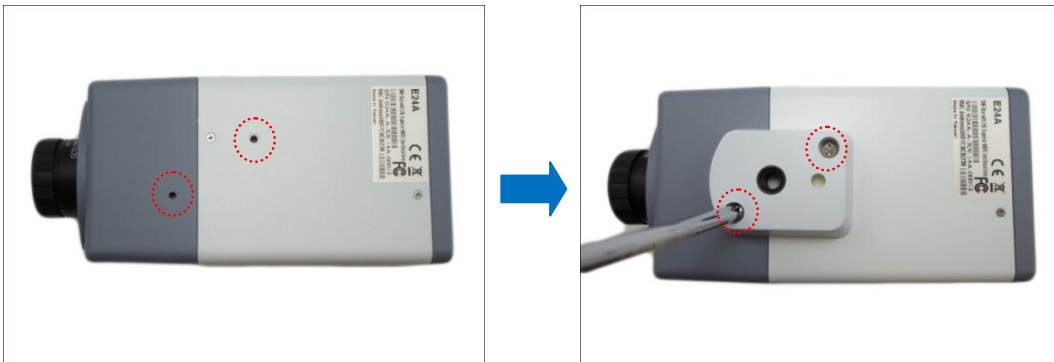

Step 3: Mount the Indoor Bracket

NOTE:

- The indoor bracket is not included in the camera package and must be purchased separately.
- The pictures on the succeeding pages are for reference only, camera labels and appearance may vary depending on camera model.

Before installing the bracket, make sure the ceiling or wall can bear more than the weight of the camera and its accessories.

Install the indoor bracket to the ceiling or wall using the three (3) screws included in the bracket package.



Step 4: Attach the Camera to the Bracket

NOTE: The following images show the mounting bracket attached on the bottom side of the camera. Same procedures apply when attaching the mounting bracket on the top side.

1. If necessary, insert a memory card into the memory card slot of the camera with the metal contacts facing down. Push until the card clicks into place. See [How to Install / Remove the Memory Card](#) on page 36 for more information.



2. Slightly loosen the knurled knob.



3. Screw the camera to the bracket by its mounting block.

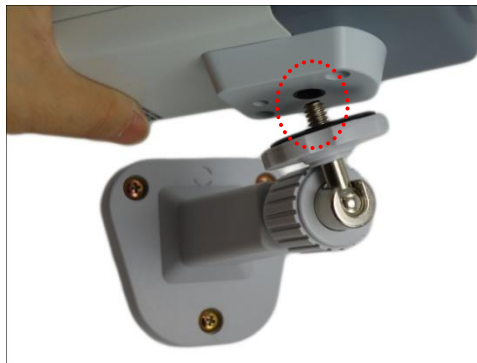

4. Tighten the hand knob until the camera is secured to the bracket.



5. Adjust the camera angle.



6. Tighten the knurled knob to fix the camera position.



7. Remove the protective cap from the lens (if any).



Step 5: Connect the Cable(s)

1. Connect the network cable to the Ethernet port of the camera.



2. If necessary, connect audio input/output or DI/DO devices to the camera. See [How to Connect DI/DO and Audio Devices](#) on page 25 for more information.

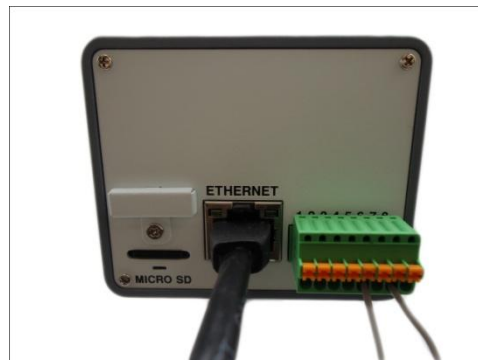

3. Connect the other end of the network cable to a switch or injector. Then, connect the switch or injector to a network, PC and a power source. See Power-over-Ethernet (PoE) connection example below.

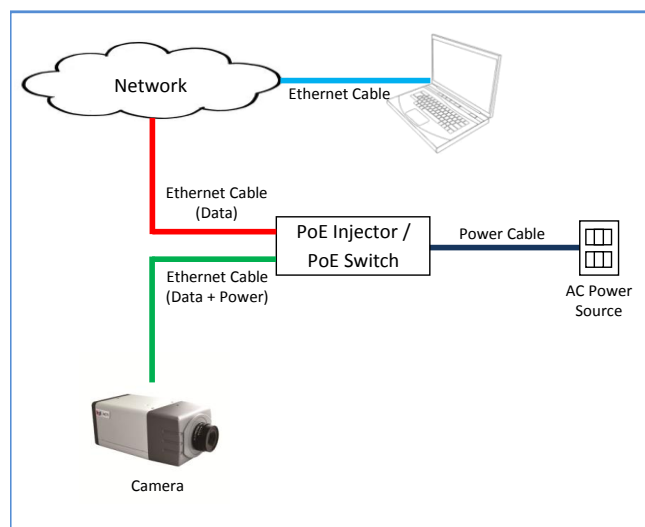

Step 6: Access the Camera Live View

See *Accessing the Camera* on page 39 for more information on how to access the Live View of the camera.

Step 7: Adjust the Viewing Angle and Focus

Based on the live view, adjust the focus and the viewing angle of the camera. Adjustments vary depending on model, for detailed information, see:

- *D21FA / E21FA* on page 34
- *D22FA / E22FA / E217 / E270* on page 34
- *D2xVA / E2xVA / E23A / E23B / E24A / E25A / E222 / E271* on page 35

Other Connections (Optional)

This section describes the procedures in preparing the external devices that you can connect to the camera. The camera supports Digital Input and Output (DI/DO), Audio Input and Output devices, and DC12V power input (for E222 only) that can be connected to the camera using the bundled terminal blocks. The use of these devices, however, is optional.

How to Connect DI/DO and Audio Devices

Depending on your surveillance needs, you may connect digital input / output or audio input / output devices to your camera. The camera comes with one (1) terminal block for both digital and audio input/output devices.

How to Connect DI/DO Devices

Digital Input (DI) devices can be used to notify the camera about an activity in the camera site. DI can be triggers of events. For example, you can connect a “panic button” to the camera; as such when the panic button is pressed, the alarm signal will be sent through the camera. Other common DI device applications are emergency button, smoke detector, passive infrared sensor, etc.

Digital Output (DO) devices are external devices that are activated by the camera upon an event inside the camera. For example, you can connect an “alarm horn” to the camera; as such when an event occurs inside the camera (e.g. detected intruder), the alarm horn will sound. Other common DO device applications are motion-triggered lights, electric fence, magnetic door locks, etc.

1. Press and hold the orange tab as you insert the wire through the pin slot, then release the orange tab to secure the wire. The terminal block label varies depending on camera model.

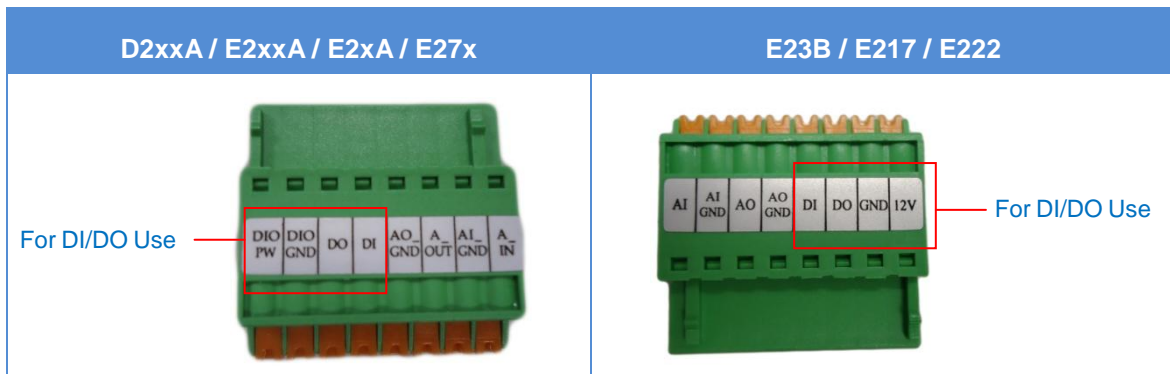

2. To connect digital input / output devices (DI/DO), map the pins to one of the pin combinations below:

Device	Pin	Mapping Instructions
Digital Output (DO)	DIO PW / 12V	Connect the wires of the output device to DIO PW or 12V and DO .
	DO	
Digital Input (DI)	DIO GND or GND	Connect the wires of the input device to DIO GND or GND and DI .
	DI	

3. After mapping the pins, connect the terminal block to the **I/O** connector of the camera.

DI/DO Connection Specifications

The table below shows the DI/DO connection specifications:

Device			
DI	Connection design		TTL - compatible logic levels
	Voltage	To trigger (low)	Logic level 0: 0V ~ 0.4V
		Normal (high)	Logic level 1: 3.1V ~ 30V
	Current		10mA ~ 100mA
DO	Connection design		Transistor (Open Collector)
	Voltage & Current		< 24V DC, < 50mA

Typical Connection

Based on these specifications, if the DI device has a voltage of 0V ~ 30V or the DO device has a voltage of < 24V (< 50mA), then the camera can supply internal power to these devices and there is no need to connect the DI/DO device to an external power source.

Use the **DIO GND** and **DI** pins to connect a DI device and use the **DIO PW** and **DO** pins to connect a DO device. See wiring scheme below:

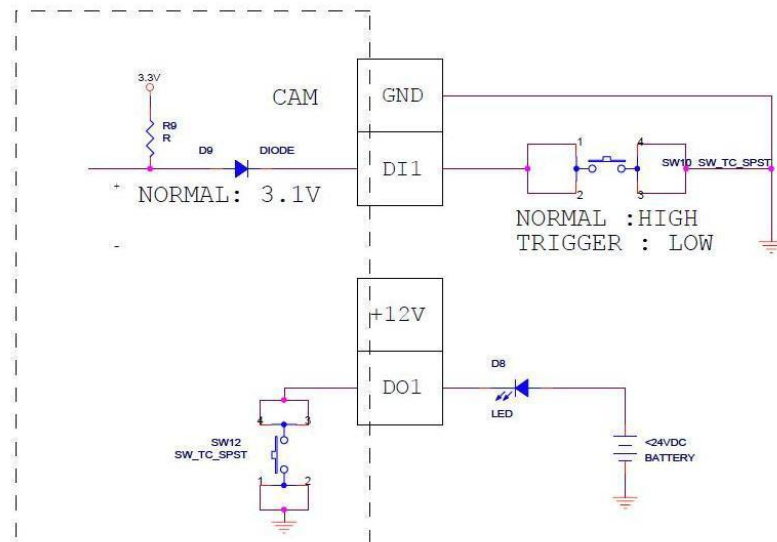

High Voltage DO Device Connection

Even though the camera provides 12V power, this may not be enough for some high voltage DO devices, such as a ceiling light or a motor that opens or closes a gate. In this case, there is a need to connect an external relay. See wiring scheme below:

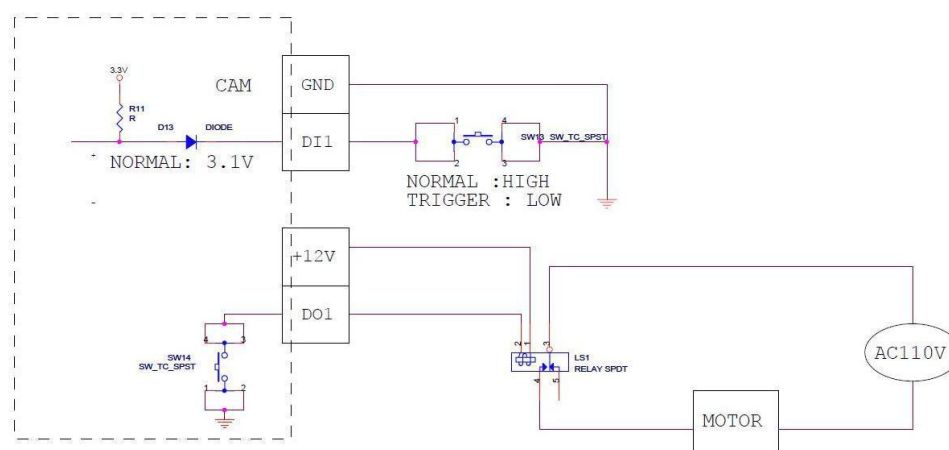

Note that when choosing an appropriate relay, please refer to its specifications and make sure they match the above design. The triggering circuit voltage has to be around 12V DC and the switch-controlled circuit voltage has to match the external power supply (e.g. 110V AC or 220V AC).

The illustration below is a graphic example of connecting a relay to a high voltage DO device.

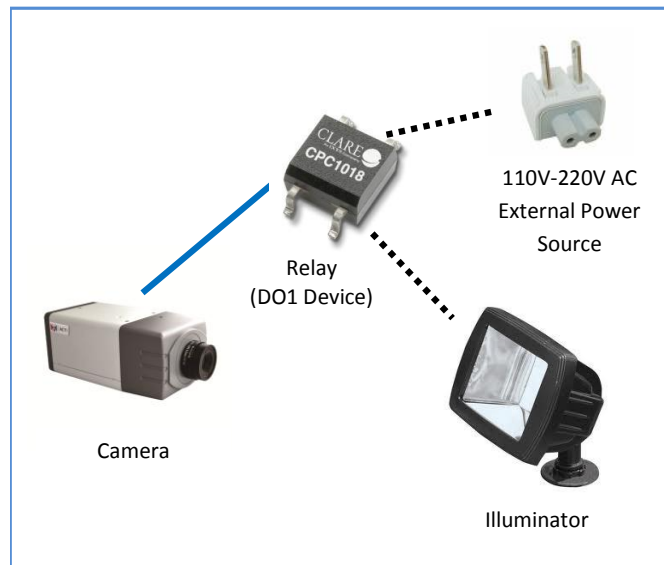

NOTE: For more information on DI/DO connections, please refer to the Knowledge Base article [All About Digital Input and Digital Output](http://Download.acti.com?id=516) downloadable from the link below (<http://Download.acti.com?id=516>).

How to Connect Audio Devices

Audio input / output devices, such as an active microphone or speaker can be connected to the camera using the supplied terminal block.

1. Press and hold the orange tab as you insert the wire through the pin slot, then release the orange tab to secure the wire.

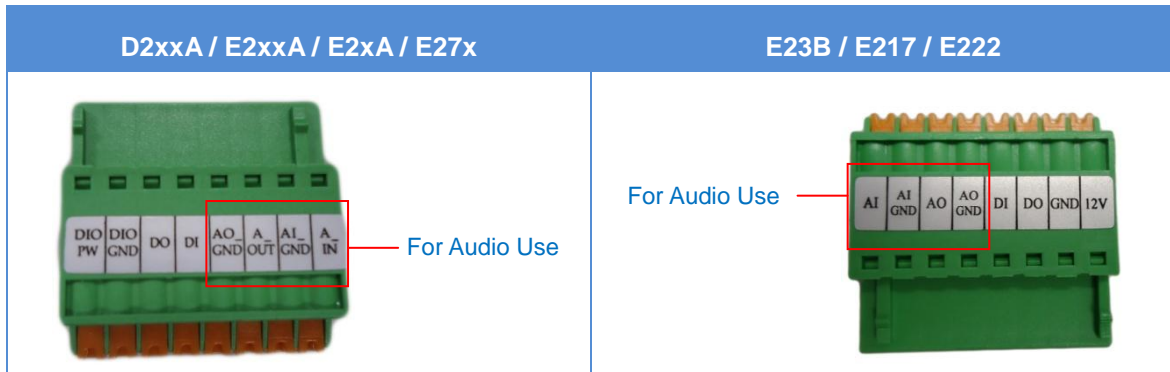

2. To connect audio devices, map the pins to one of the pin combinations below:

Device	Pin	Mapping Instructions
Audio Output (AO)	AO GND	Connect the wires of the audio output device to AO GND and A_OUT or AO .
	A_OUT or AO	
Audio Input (A1)	AI GND	Connect the wires of the audio input device to AI GND and A_IN or AI .
	A_IN or AI	

NOTE: For more information about AUDIO in connections, please refer to the Knowledge Base article [How to Use Audio-in of ACTi Cameras](http://Download.acti.com?id=534), downloadable from the link below (<http://Download.acti.com?id=534>).

3. When ready, connect the terminal block to the **I/O** connector of the camera.

How to Connect a Power Adapter (for E217, E222 only)

In case of using a non-PoE switch or your PoE switch has limited power supply, you can purchase a power adapter and directly connect the camera to a power outlet. The power adapter must be connected to the supplied terminal block before use.

To do this, follow the procedures below:

1. Loosen the screws of the **12V** and **GND** pins of the power terminal block.



2. Take note that a standard power adapter cable has two (2) different wires:

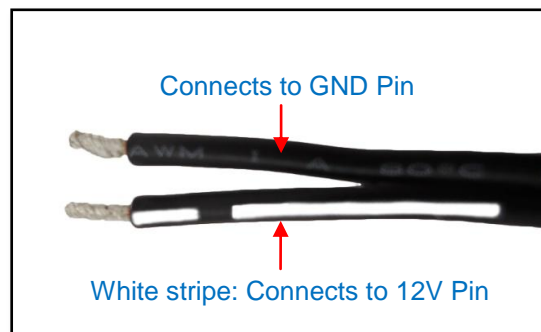

3. Connect the wire with the white stripe to the **12V** pin and the other to the **GND** pin.

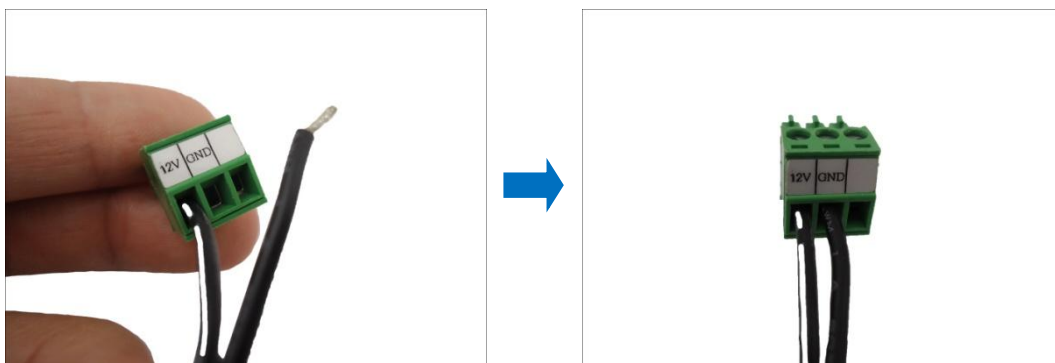

NOTE: The terminal block pictures are for reference only, note that actual label placement may vary per model.

4. Tighten the screws of the **12V** pin and the **GND** pins to secure the wire connection.



5. When ready, connect the prepared power adapter to the **POWER** connector of the camera.
Below is an example of a power adapter with an attached terminal block.



NOTE: The power adapter is not bundled in the package.

How to Connect a Serial Device (for E23B, E217, E222 only)

The camera can be connected to a **Pan-Tilt (PT) Scanner** (Pan-Tilt Head) using the serial port connector. This allows the zoom camera to do pan and tilt using the Pelco-D protocol. Most PT scanners accept Pelco-D and Pelco-P protocol commands via RS-485 or RS-422 connection, which are both supported by your camera.

Check the connection available on the PT scanner and connect it to your camera following the procedures below.

1. Map the wires from the PT scanner to your camera using the supplied terminal block according to one of the tables below.

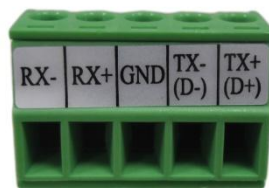

Via RS-485 Connection

Terminal Block Label	Wire Mapping	
	Camera Pin	PT Scanner Pin
RX-	-	
RX+	-	
GND	GROUND PIN	
TX- (D-)	TX- (D-)	DATA-
TX+ (D+)	TX+ (D+)	DATA+

Via RS-422 Connection

Terminal Block Label	Wire Mapping	
	Camera Pin	PT Scanner Pin
RX-	RX -	TX -
RX+	RX +	TX +
GND	GROUND PIN	
TX- (D-)	TX -	RX -
TX+ (D+)	TX +	RX +

NOTE: The pins of the PT Scanner may be labeled differently depending on the location or country where the scanner is purchased. For example, some PT devices may have RS-485 **DATA+** pins labeled as “TX+”, “RX+”, “A” or “485+”, etc. Refer to the scanner documentation or contact the manufacturer to verify the corresponding pin labels and ensure proper wiring connection.



CAUTION: Incorrect wiring may cause damage to the connected devices.

DISCLAIMER: ACTi will not be responsible for any damage caused by improper wiring.

2. Connect a ground wire to one of the **GND** terminal pin to complete the connection.
3. After mapping the pins, connect the terminal block to the **Serial Port** connector of the camera.

Other Adjustments and Accessories

How to Adjust the Viewing Angle and Focus

This section describes the procedures in adjusting the viewing angle and focus of the camera. The camera already comes pre-focused when you take it out the box. In case there is a need to modify the default focus and viewing angle, do the procedures below to make the necessary adjustments.

D21FA / E21FA

1. Turn the lens knob left or right to adjust the focus.



2. If necessary, tighten the lever screw to fix its position to avoid moving the lens.



D22FA / E22FA / E217 / E270

Turn the lens knob left or right to adjust the focus.



D2xVA / E2xVA / E23A / E23B / E24A / E25A / E222 / E271

The camera comes with the focus and viewing angle already fixed. If necessary, do the following to modify the focus and viewing angle.

1. Loosen the zoom lever screw, then turn left or right to adjust the viewing angle.



2. Loosen the focus lever screw, then turn left or right to adjust the focus.



3. When done, tighten the lever screws to fix their position.



How to Install / Remove the Memory Card

The camera supports local video recording or saving of snapshots to a memory card.

NOTE: Supports microSDHC and microSDXC cards.

How to Insert the Memory Card

1. Insert a memory card into the card slot with the metallic contacts facing down the camera. Push the card until it clicks into place.



2. To avoid unauthorized removal of the card, cover the memory card slot. To do this, loosen the screw and turn the tab to cover the memory card slot. Once the tab is in place, tighten the screw.

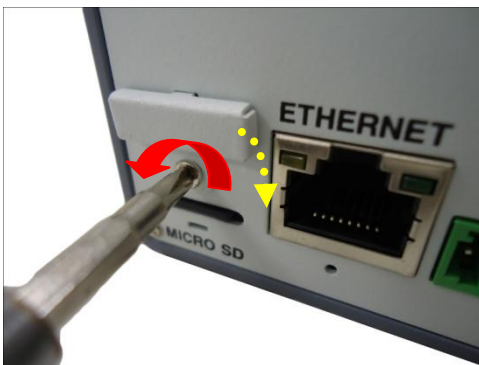

How to Remove the Memory Card

In case there is a need to remove the card, make sure to access the camera Web Configurator to safely "unmount" the card first (see the camera Firmware manual for more information). Once unmounted from the firmware, push the card to eject it from the slot.

How to Replace the Lens

Depending on your surveillance needs, the bundled lens can be replaced with a vari-focal lens with wider viewing angle or change to a DC-iris, etc. Contact your sales agent to purchase.

To replace the bundled lens, do the following:

1. Rotate the lens counter-clockwise until the lens is detached from the camera.



2. Twist and pull to remove the cap from the threaded end of the replacement lens.



3. Screw the replacement lens to the camera.



4. For lens with DC-iris, connect the lens cable to the DC-iris port of the camera.



5. Pull to remove the protective cap from the replacement lens.



Accessing the Camera

Configure the IP Addresses

In order to be able to communicate with the camera from your PC, both the camera and the PC have to be within the same network segment. In most cases, it means that they both should have very similar IP addresses, where only the last number of the IP address is different from each other. There are 2 different approaches to IP Address management in Local Area Networks – by DHCP Server or Manually.

Using DHCP server to assign IP addresses:

If you have connected the computer and the camera into the network that has a DHCP server running, then you do not need to configure the IP addresses at all – both the camera and the PC would request a unique IP address from DHCP server automatically. In such case, the camera will immediately be ready for the access from the PC. The user, however, might not know the IP address of the camera yet. It is necessary to know the IP address of the camera in order to be able to access it by using a Web browser.

The quickest way to discover the cameras in the network is to use the simplest network search, built in the Windows system – just by pressing the “Network” icon, all the cameras of the local area network will be discovered by Windows thanks to the UPnP function support of our cameras.

In the example below, we successfully the camera model that we had just connected to the network.

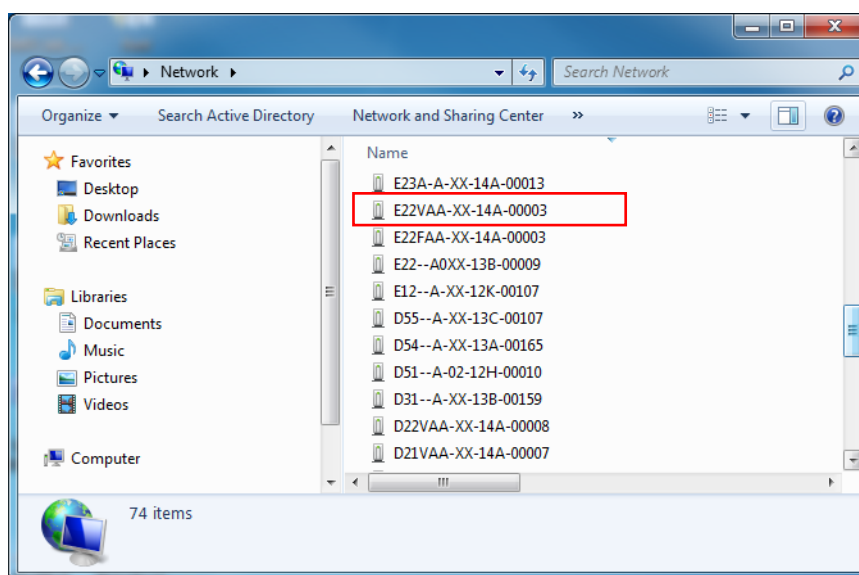

Double-click the mouse button on the camera model, the default browser of the PC is automatically launched and the IP address of the target camera is already filled in the address bar of the browser.

If you work with our cameras regularly, then **there is even a better way to discover the cameras in the network** – by using **IP Utility**. The IP Utility is a light software tool that can not only discover the cameras, but also list lots of valuable information, such as IP and MAC addresses, serial numbers, firmware versions, etc, and allows quick configuration of multiple devices at the same time.

Search and download IP Utility for free from <http://www.acti.com/DownloadCenter>.

With just one click, you can launch the IP Utility and there will be an instant report as follows:

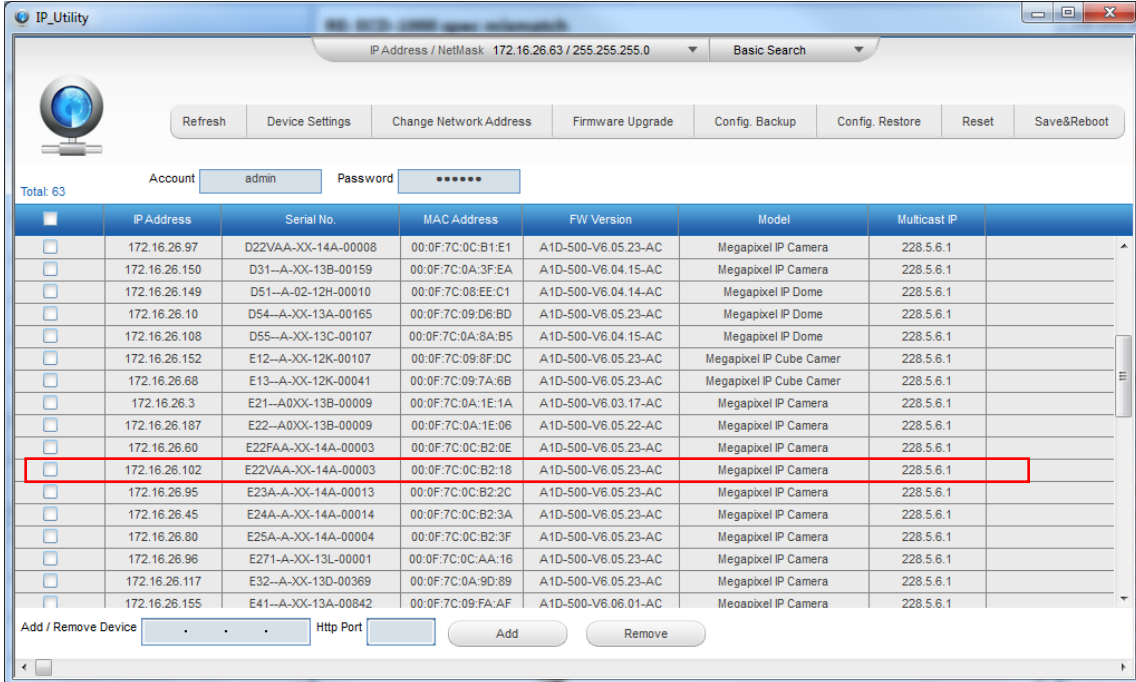

	IP Address	Serial No.	MAC Address	FW Version	Model	Multicast IP
<input type="checkbox"/>	172.16.26.97	D22VAA-XX-14A-00008	00:0F:7C:0C:B1:E1	A1D-500-V6.05.23-AC	Megapixel IP Camera	228.5.6.1
<input type="checkbox"/>	172.16.26.150	D31--A-XX-13B-00159	00:0F:7C:0A:3F:EA	A1D-500-V6.04.15-AC	Megapixel IP Camera	228.5.6.1
<input type="checkbox"/>	172.16.26.149	D51--A-02-12H-00010	00:0F:7C:08:EE:C1	A1D-500-V6.04.14-AC	Megapixel IP Dome	228.5.6.1
<input type="checkbox"/>	172.16.26.10	D54--A-XX-13A-00165	00:0F:7C:09:D6:BD	A1D-500-V6.05.23-AC	Megapixel IP Dome	228.5.6.1
<input type="checkbox"/>	172.16.26.108	D55--A-XX-13C-00107	00:0F:7C:0A:8A:B5	A1D-500-V6.04.15-AC	Megapixel IP Dome	228.5.6.1
<input type="checkbox"/>	172.16.26.152	E12--A-XX-12K-00107	00:0F:7C:09:8F:DC	A1D-500-V6.05.23-AC	Megapixel IP Cube Camer	228.5.6.1
<input type="checkbox"/>	172.16.26.68	E13--A-XX-12K-00041	00:0F:7C:09:7A:6B	A1D-500-V6.05.23-AC	Megapixel IP Cube Camer	228.5.6.1
<input type="checkbox"/>	172.16.26.3	E21--A0XX-13B-00009	00:0F:7C:0A:1E:1A	A1D-500-V6.03.17-AC	Megapixel IP Camera	228.5.6.1
<input type="checkbox"/>	172.16.26.187	E22--A0XX-13B-00009	00:0F:7C:0A:1E:06	A1D-500-V6.05.22-AC	Megapixel IP Camera	228.5.6.1
<input type="checkbox"/>	172.16.26.60	E22FAA-XX-14A-00003	00:0F:7C:0C:B2:0E	A1D-500-V6.05.23-AC	Megapixel IP Camera	228.5.6.1
<input type="checkbox"/>	172.16.26.102	E22VAA-XX-14A-00003	00:0F:7C:0C:B2:18	A1D-500-V6.05.23-AC	Megapixel IP Camera	228.5.6.1
<input type="checkbox"/>	172.16.26.95	E23A-A-XX-14A-00013	00:0F:7C:0C:B2:2C	A1D-500-V6.05.23-AC	Megapixel IP Camera	228.5.6.1
<input type="checkbox"/>	172.16.26.45	E24A-A-XX-14A-00014	00:0F:7C:0C:B2:3A	A1D-500-V6.05.23-AC	Megapixel IP Camera	228.5.6.1
<input type="checkbox"/>	172.16.26.80	E25A-A-XX-14A-00004	00:0F:7C:0C:B2:3F	A1D-500-V6.05.23-AC	Megapixel IP Camera	228.5.6.1
<input type="checkbox"/>	172.16.26.96	E271-A-XX-13L-00001	00:0F:7C:0C:AA:16	A1D-500-V6.05.23-AC	Megapixel IP Camera	228.5.6.1
<input type="checkbox"/>	172.16.26.117	E32--A-XX-13D-00369	00:0F:7C:0A:9D:89	A1D-500-V6.05.23-AC	Megapixel IP Camera	228.5.6.1
<input type="checkbox"/>	172.16.26.155	E41--A-XX-13A-00842	00:0F:7C:09:FA:AF	A1D-500-V6.06.01-AC	Megapixel IP Camera	228.5.6.1

You can quickly notice the camera model in the list. Click on the IP address to automatically launch the default browser of the PC with the IP address of the target camera filled in the address bar of the browser already.

Use the default IP address of a camera:

If there is no DHCP server in the given network, the user may have to assign the IP addresses to both PC and camera manually to make sure they are in the same network segment.

When the camera is plugged into network and it does not detect any DHCP services, it will automatically assign itself a default IP:

192.168.0.100

Whereas the default port number would be **80**. In order to access that camera, the IP address of the PC has to be configured to match the network segment of the camera.

Manually adjust the IP address of the PC:

In the following example, based on Windows 7, we will configure the IP address to **192.168.0.99** and set Subnet Mask to **255.255.255.0** by using the steps below:

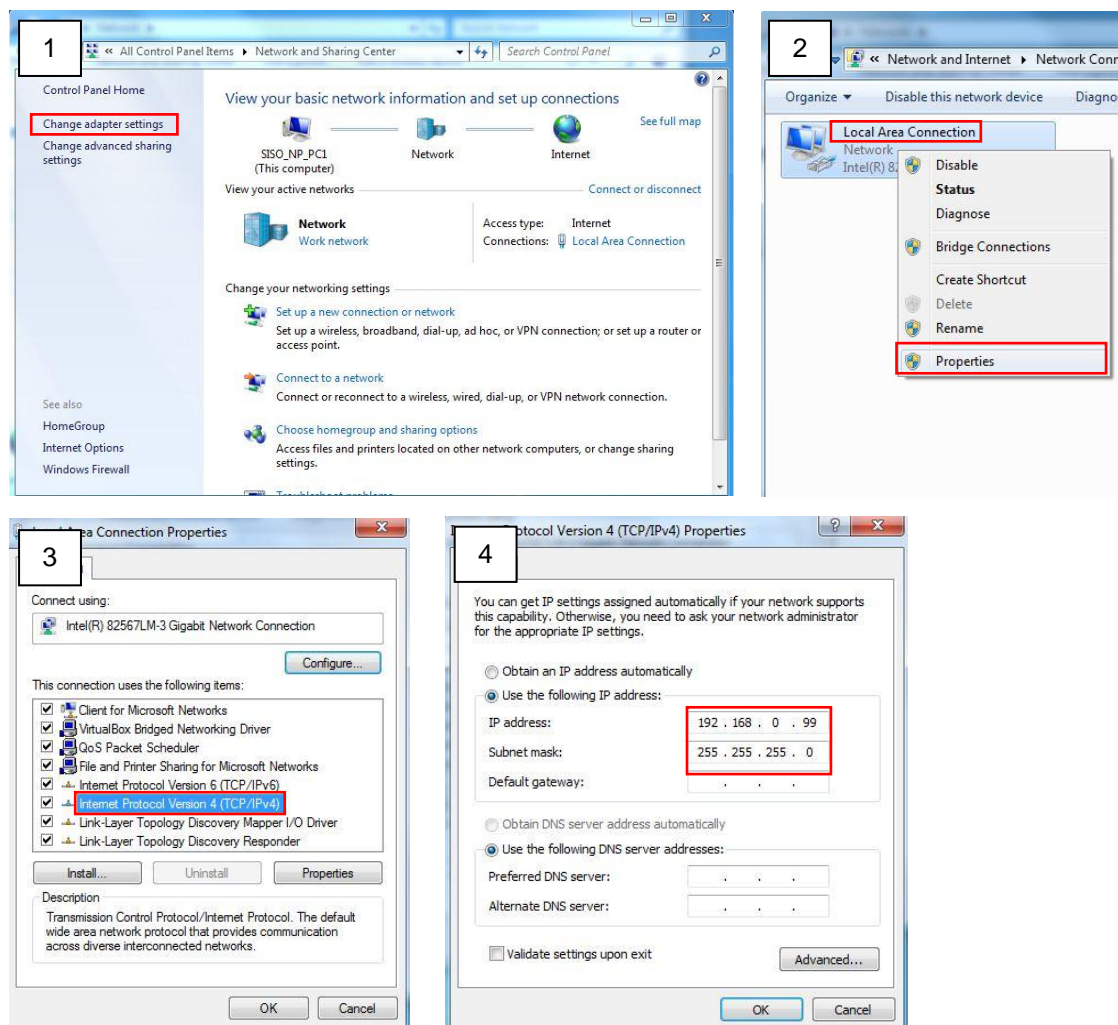

Manually adjust the IP addresses of multiple cameras:

If there are more than 1 camera to be used in the same local area network and there is no DHCP server to assign unique IP addresses to each of them, all of the cameras would then have the initial IP address of **192.168.0.100**, which is not a proper situation for network devices – all the IP addresses have to be different from each other. The easiest way to assign cameras the IP addresses is by using **IP Utility**:

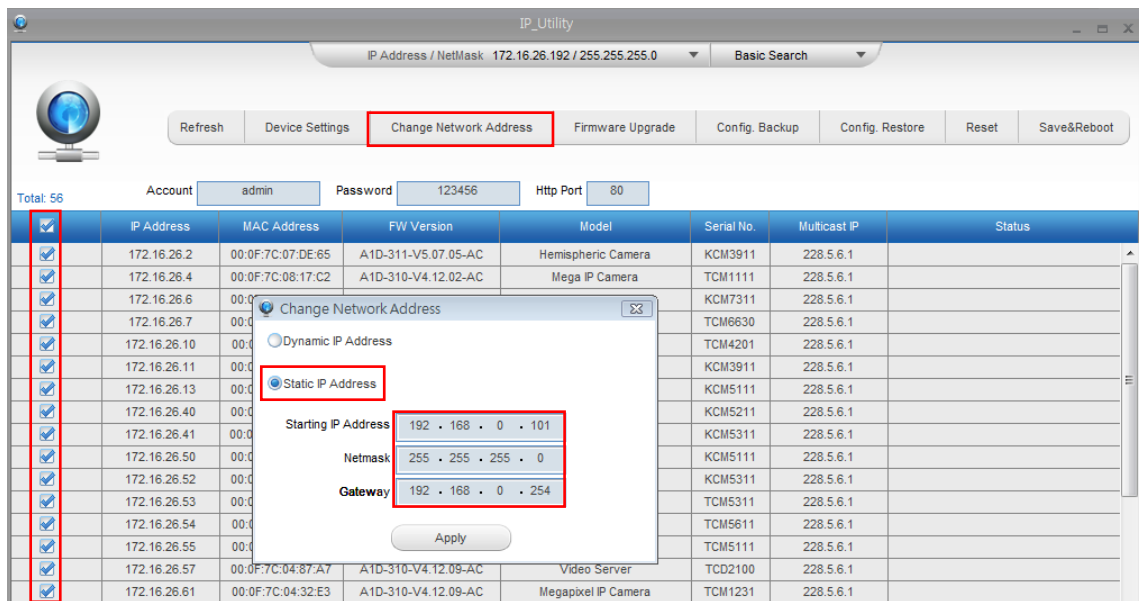

With the procedure shown above, all the cameras will have unique IP addresses, starting from 192.168.0.101. In case there are 20 cameras selected, the last one of the cameras would have the IP 192.168.0.120.

Later, by pressing the “Refresh” button of the IP Utility, you will be able to see the list of cameras with their new IP addresses.



Please note that it is also possible to change the IP addresses manually by using the Web browser. In such case, please plug in only one camera at a time, and change its IP address by using the Web browser before plugging in the next one. This way, the Web browser will not be confused about two devices having the same IP address at the same time.

Access the Camera

Now that the camera and the PC are both having their unique IP addresses and are under the same network segment, it is possible to use the Web browser of the PC to access the camera.

You can use **any of the browsers** to access the camera, however, the full functionality is provided only for **Microsoft Internet Explorer**.

The browser functionality comparison:

Functionality	Internet Explorer	Other browsers
Live Video	Yes	Yes*
Live Video Area Resizable	Yes	No
PTZ Control	Yes	Yes
Capture the snapshot	Yes	Yes
Video overlay based configuration (Motion Detection regions, Privacy Mask regions)	Yes	No
All the other configurations	Yes	Yes

* When using non-Internet Explorer browsers, free third-party software plug-ins must be installed to the PC first to be able to get the live video feed from the camera:

Browser	Required Plug-In
Safari	QuickTime (http://www.apple.com/quicktime/download/)
Other non-Internet Explorer browsers	Basic VLC Media Player (http://www.videolan.org)

Disclaimer Notice: The camera manufacturer does not guarantee the compatibility of its cameras with VLC player or QuickTime – since these are third party softwares. The third party has the right to modify their utility any time which might affect the compatibility. In such cases, please use Internet Explorer browser instead.

When using Internet Explorer browser, the ActiveX control for video stream management will be downloaded from the camera directly – the user just has to accept the use of such control when prompted so. No other third party utilities are required to be installed in such case.

The following examples in this manual are based on Internet Explorer browser in order to cover all functions of the camera.

Assuming that the camera's IP address is **192.168.0.100**, you can access it by opening the Web browser and typing the following address into Web browser's address bar:

http://192.168.0.100

Upon successful connection to the camera, the user interface called **Web Configurator** would appear together with the login page. The HTTP port number was not added behind the IP address since the default HTTP port of the camera is 80, which can be omitted from the address for convenience.

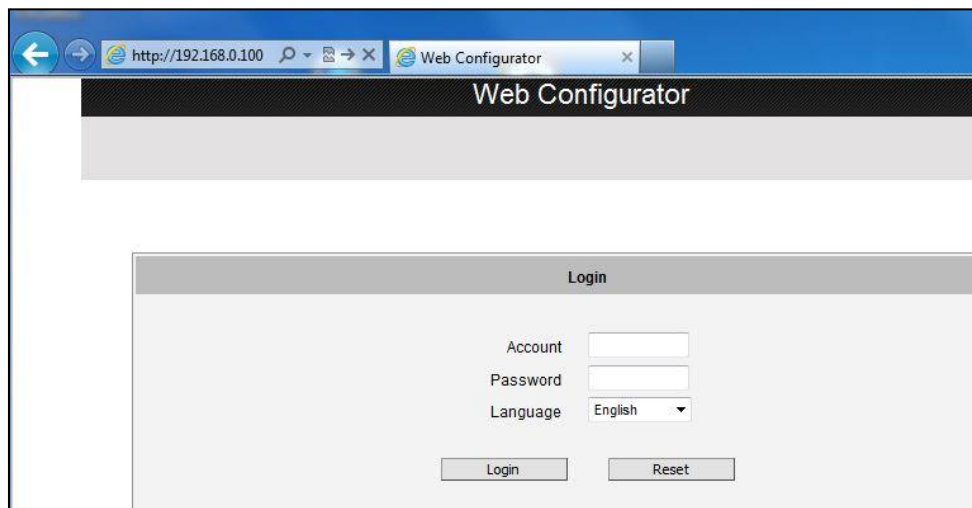

Before logging in, you need to know the factory default Account and Password of the camera.

Account: **Admin**

Password: **123456**

For further operations, please refer to the **Firmware User Manual**.



Copyright © 2015, ACTi Corporation All Rights Reserved

7F, No. 1, Alley 20, Lane 407, Sec. 2, Ti-Ding Blvd., Neihu District, Taipei, Taiwan 114, R.O.C.

TEL : +886-2-2656-2588 FAX : +886-2-2656-2599

Email: sales@acti.com