

User Manual

1 port IP KVM Gateways

IP-H101
HDMI



IP-S101
VGA



- ▶ IP Remote Access
- ▶ Quad-core Processor
- ▶ HTML-base & Java-free
- ▶ Enterprise IP Authentication
- ▶ BIOS-level Access

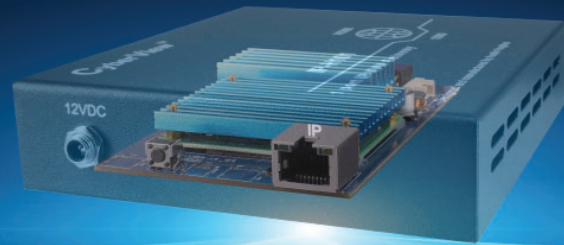

Designed and manufactured by Austin Hughes

FC CE UK CA  REACH

Legal Information

First English printing, August 2022

Information in this document has been carefully checked for accuracy; however, no guarantee is given to the correctness of the contents. The information in this document is subject to change without notice. We are not liable for any injury or loss that results from the use of this equipment.

Safety Instructions

Please read all of these instructions carefully before you use the device. Save this manual for future reference.

- Unplug equipment before cleaning. Don't use liquid or spray detergent; use a moist cloth.
- Keep equipment away from excessive humidity and heat. Preferably, keep it in an air-conditioned environment with temperatures not exceeding 40° Celsius (104° Fahrenheit).
- When installing, place the equipment on a sturdy, level surface to prevent it from accidentally falling and causing damage to other equipment or injury to persons nearby.
- When the equipment is in an open position, do not cover, block or in any way obstruct the gap between it and the power supply. Proper air convection is necessary to keep it from overheating.
- Arrange the equipment's power cord in such a way that others won't trip or fall over it.
- If you are using a power cord that didn't ship with the equipment, ensure that it is rated for the voltage and current labeled on the equipment's electrical ratings label. The voltage rating on the cord should be higher than the one listed on the equipment's ratings label.
- Observe all precautions and warnings attached to the equipment.
- If you don't intend on using the equipment for a long time, disconnect it from the power outlet to prevent being damaged by transient over-voltage.
- Keep all liquids away from the equipment to minimize the risk of accidental spillage. Liquid spilled on to the power supply or on other hardware may cause damage, fire or electrical shock.
- Only qualified service personnel should open the chassis. Opening it yourself could damage the equipment and invalidate its warranty.
- If any part of the equipment becomes damaged or stops functioning, have it checked by qualified service personnel.

What the warranty does not cover

- Any product, on which the serial number has been defaced, modified or removed.
- Damage, deterioration or malfunction resulting from:
 - Accident, misuse, neglect, fire, water, lightning, or other acts of nature, unauthorized product modification, or failure to follow instructions supplied with the product.
 - Repair or attempted repair by anyone not authorized by us.
 - Any damage of the product due to shipment.
 - Removal or installation of the product.
 - Causes external to the product, such as electric power fluctuation or failure.
 - Use of supplies or parts not meeting our specifications.
 - Normal wear and tear.
 - Any other causes which does not relate to a product defect.
- Removal, installation, and set-up service charges.

Regulatory Notices Federal Communications Commission (FCC)

This equipment has been tested and found to comply with the limits for a Class B digital device, pursuant to Part 15 of the FCC rules. These limits are designed to provide reasonable protection against harmful interference in a residential installation.

Any changes or modifications made to this equipment may void the user's authority to operate this equipment. This equipment generates, uses, and can radiate radio frequency energy and, if not installed and used in accordance with the instructions, may cause harmful interference to radio communications.

However, there is no guarantee that interference will not occur in a particular installation. If this equipment does cause harmful interference to radio or television reception, which can be determined by turning the equipment off and on, the user is encouraged to try to correct the interference by one or more of the following measures:

- Re-position or relocate the receiving antenna.
- Increase the separation between the equipment and receiver.
- Connect the equipment into an outlet on a circuit different from that to which the receiver is connected.

Contents

< Part. 1 > IP-S101

1.1	Package Content	P.2
1.2	Specification	P.2
1.3	Connections	P.3

< Part. 2 > IP-H101

2.1	Package Content	P.4
2.2	Specification	P.4
2.3	Connections	P.5

< Part. 3 > IP 1080 Setup

3.1	Configure the target server	P.6
3.2	Logging in to IP KVM	P.7
3.3	Configure Remote Console Resolution	P.7
3.4	Launch remote console	P.8

- It is very important to mount the equipment in a suitable cabinet or on a stable surface.
- Make sure the place has a good ventilation, is out of direct sunlight, away from sources of excessive dust, dirt, heat, water, moisture and vibration.

Unpacking

The equipment comes with the standard parts shown in package content. Check and make sure they are included and in good condition. If anything is missing, or damaged, contact the supplier immediately.

< Part. 1 >

< 1.1 > Package Content



- 1 port IP VGA KVM gateway x 1
- 6 ft VGA KVM cable (CB-6) x 1
- 12V power adapter x 1
- 6 ft power cord x 1

< 1.2 > Specification

KVM Port	
Connector :	Combo DB-15 (Video + KB / MS)
Connectivity :	6 ft VGA KVM cable (CB-6)
Resolution :	16 : 9 - max. 1920 x 1080 16 : 10 - max. 1920 x 1200 4 : 3 - max. 1600 x 1200

Local Console	
Graphic Connector :	1 x DB-15 VGA
Input device :	2 x USB type A for keyboard & mouse
Resolution :	16 : 9 - max. 1920 x 1080 16 : 10 - max. 1920 x 1200 4 : 3 - max. 1600 x 1200

IP Console	
Connector :	1000 BaseT Gigabit Ethernet Port (RJ45)
User management :	1 x active user, 15-user login
Network protocol :	DHCP / BOOTP / DNS
Security :	TLS 1.3, AES, LDAP, Active Directory (AD), HTTP(s)
Browser :	Chrome, Firefox, Edge, etc.
Resolution :	16:9 - max. 1920 x 1080 16:10 - max. 1920 x 1200 4:3 - max. 1600 x 1200

Power	
Input	12V Power Adapter
Consumption	Max. 11W

Physical	
Product (W x D x H)	125 x 123.5 x 30 mm 4.92 x 4.86 x 1.18 inch
Packing (W x D x H)	358 x 257 x 55 mm 14.09 x 10.12 x 2.17 inch
Weight	Net 0.492 kg / 1.08 lb
	Gross 1.20 kg / 2.65 lb
Chassis color	Dark
Chassis materials	Steel

Compliance	
EMC	FCC & CE
Safety	CE / LVD & UKCA
Environment	RoHS3 & REACH / WEEE

Environment	
Operating temp.	0 to 55°C degree
Storage temp.	-20 to 60°C degree
Operating humidity	10 to 90%, non-condensing
Storage humidity	5 to 90%, non-condensing
Operating altitude	16,000 ft
Non-operating altitude	40,000 ft
Shock	10G acceleration (11ms duration)
Vibration	5-500Hz 1G RMS random vibration

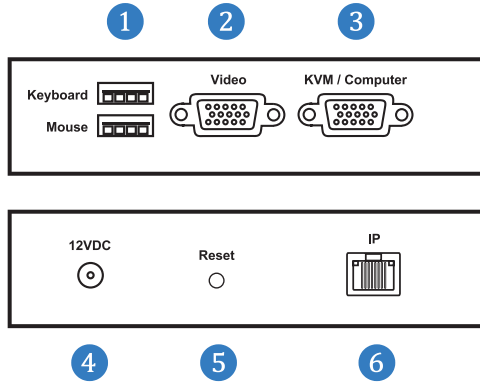
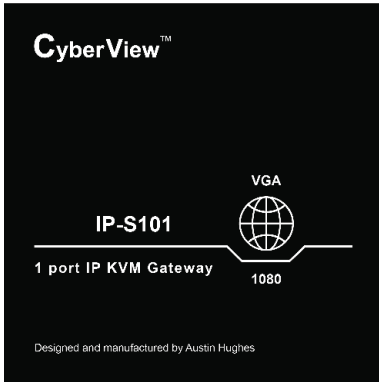

- 1 USB-A to Keyboard & Mouse
- 2 VGA Output to Video
- 3 DB-15 Input to KVM/ Computer
- 4 12VDC Power Input
- 5 Reset
- 6 1000 BaseT Gigabit Ethernet Port

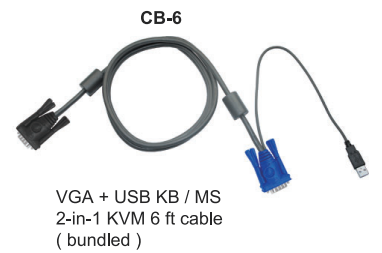
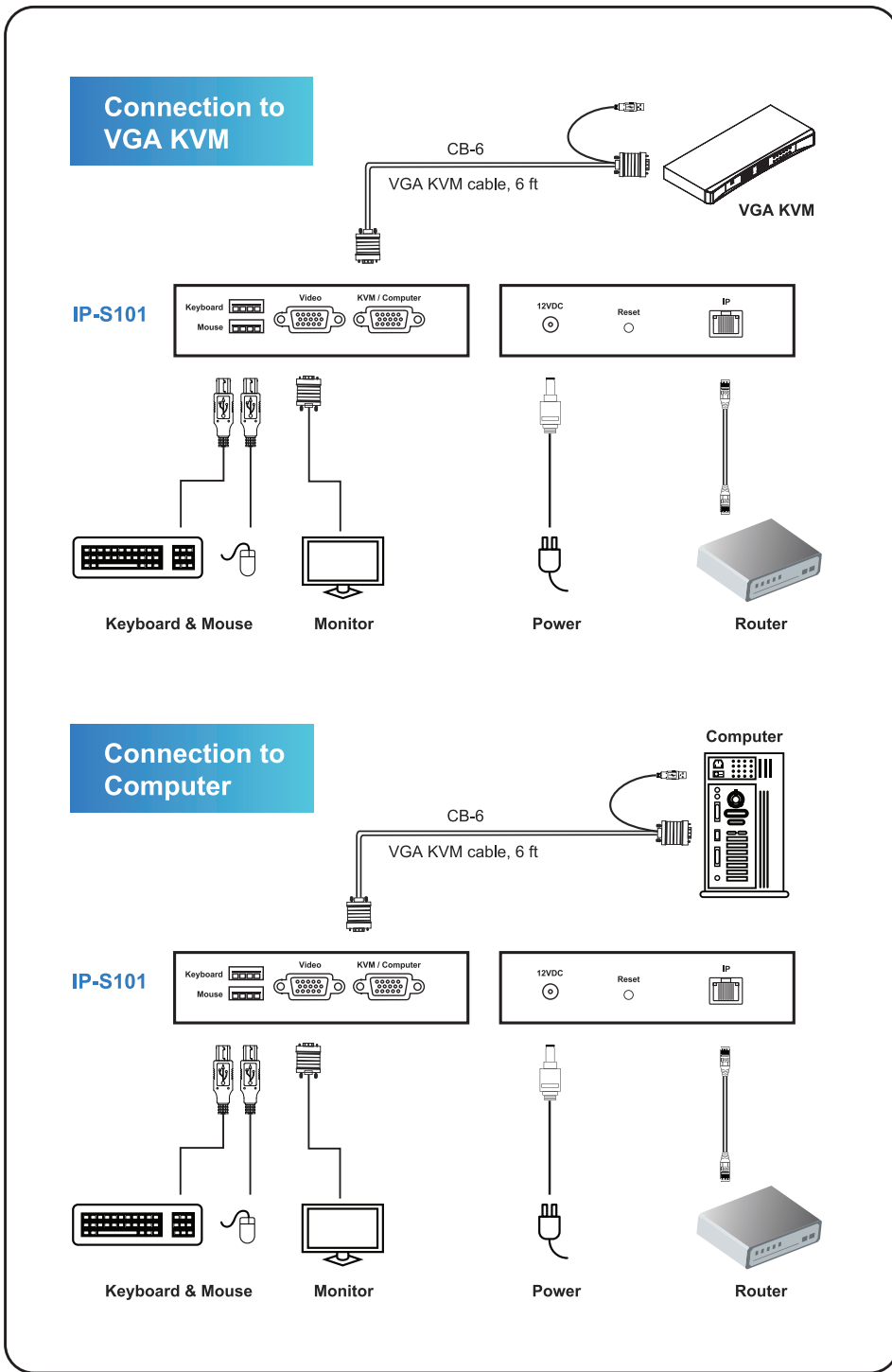

- It is very important to mount the equipment in a suitable cabinet or on a stable surface.
- Make sure the place has a good ventilation, is out of direct sunlight, away from sources of excessive dust, dirt, heat, water, moisture and vibration.

Unpacking

The equipment comes with the standard parts shown in package content. Check and make sure they are included and in good condition. If anything is missing, or damaged, contact the supplier immediately.

< Part. 2 >

< 2.1 > Package Content



- 1 port IP HDMI KVM gateway x 1
- 6 ft HDMI KVM cable (CH-6H) x 1
- 12V power adapter x 1
- 6 ft power cord x 1

< 2.2 > Specification

KVM Port	
Connector :	HDMI 1.4 + USB-B (Video + KB / MS)
Connectivity :	6 ft HDMI KVM cable (CH-6H)
Resolution :	16 : 9 - max. 1920 x 1080 16 : 10 - max. 1920 x 1200 4 : 3 - max. 1600 x 1200

Local Console	
Keyboard / Mouse :	2 x USB-A
Video :	1 x HDMI 1.4
Resolution :	16 : 9 - max. 1920 x 1080 16 : 10 - max. 1920 x 1200 4 : 3 - max. 1600 x 1200

IP Console	
Connector :	1000 BaseT Gigabit Ethernet Port (RJ45)
User management :	1 x active user, 15-user login
Network protocol :	DHCP / BOOTP / DNS
Security :	TLS 1.3, AES, LDAP, Active Directory (AD), HTTP(s)
Browser :	Chrome, Firefox, Edge, etc.
Resolution :	16:9 - max. 1920 x 1080 16:10 - max. 1920 x 1200 4:3 - max. 1600 x 1200

Power	
Input	12V Power Adapter
Consumption	Max. 11W

Physical		
Product (W x D x H)	125 x 123.5 x 30 mm	
	4.92 x 4.86 x 1.18 inch	
Packing (W x D x H)	358 x 257 x 55 mm	
	14.09 x 10.12 x 2.17 inch	
Weight	Net	0.478 kg / 1.05 lb
	Gross	1.31 kg / 2.89 lb
Chassis color	Dark	
Chassis materials	Steel	

Compliance	
EMC	FCC & CE
Safety	CE / LVD & UKCA
Environment	RoHS3 & REACH / WEEE

Environment	
Operating temp.	0 to 55°C degree
Storage temp.	-20 to 60°C degree
Operating humidity	10 to 90%, non-condensing
Storage humidity	5 to 90%, non-condensing
Operating altitude	16,000 ft
Non-operating altitude	40,000 ft
Shock	10G acceleration (11ms duration)
Vibration	5-500Hz 1G RMS random vibration

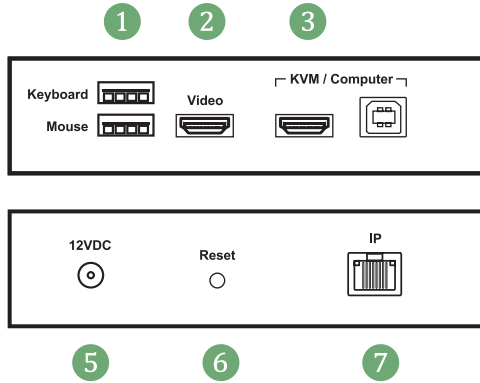
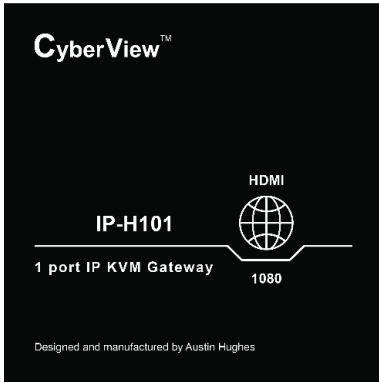

- 1 USB-A to Keyboard & Mouse
- 2 HDMI Output to Monitor
- 3 HDMI to KVM Switch / Computer
- 4 USB-B to KVM Switch / Computer
- 5 12VDC Power Input
- 6 Reset
- 7 1000 BaseT Gigabit Ethernet Port

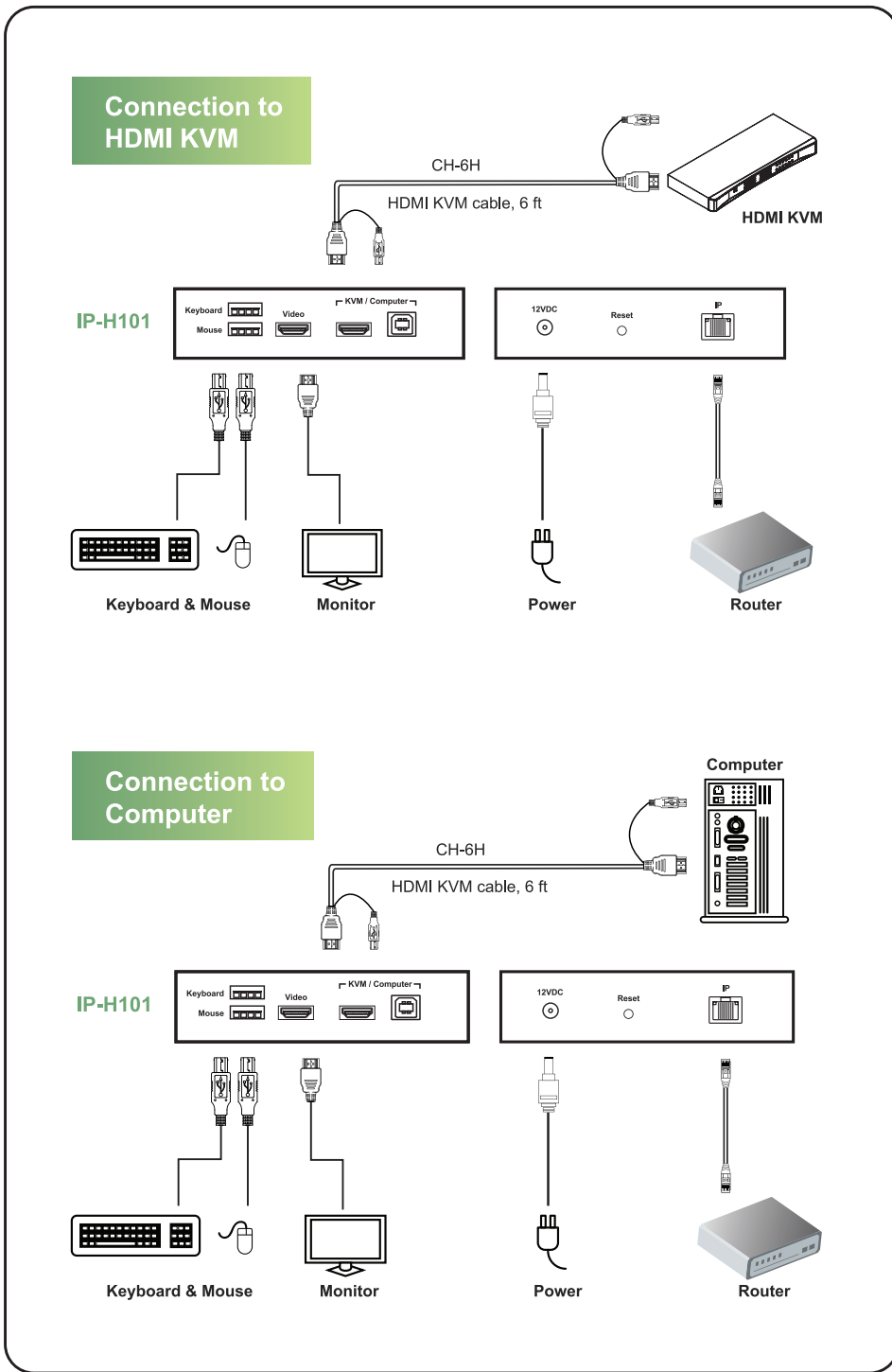

HDMI + USB 2-in-1 KVM 6 ft cable (bundled)

 Please make sure to follow the below steps to setup your KVM IP properly.

< Part. 3 >

< 3.1 > Configure the target server

The target server is the server that connected to the IP KVM Switch. Before use IP remote access, you need to turn off mouse acceleration of all target servers. Please refer to below for Windows operating system.

Mouse setting

From the Control Panel, double-click the Mouse icon to open the Mouse Properties dialog box.

1. Move the pointer speed slider to the default of 50%.
(the middle of the slider or the sixth tick from the left).
2. Uncheck “*Enhance pointer precision*”.
3. Uncheck “*Automatically move pointer to the default button in a dialog box*” & “*Display pointer trails*”.
4. Windows enables mouse acceleration by default. Make sure you are logged in to windows to check mouse synchronization.
5. Mouse acceleration can only be turned off on a per Windows user basis. If you log in to Windows with a different user name, then you will have to configure mouse properties separately for that user as well.

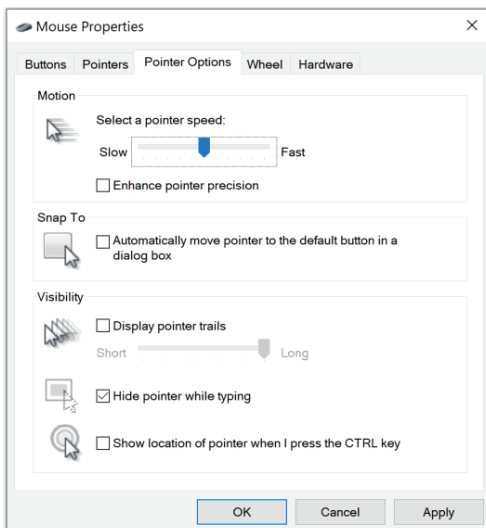

Change display scaling setting 100%

1. Open Settings.
2. Click on System.
3. Click on Display.
4. Under the “Scale and layout” section, select the scale 100%.

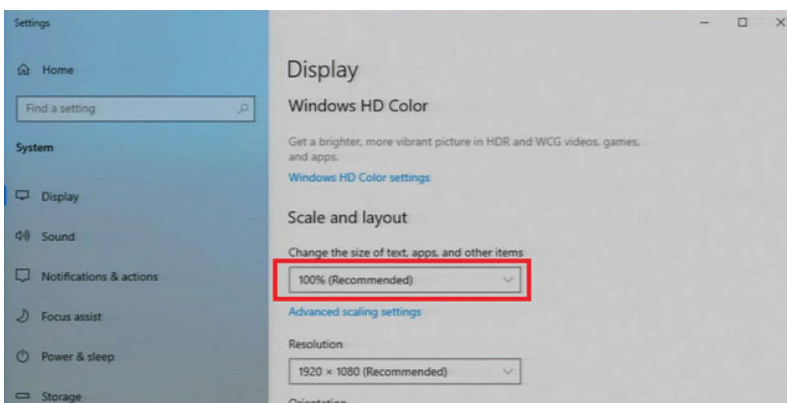

< 3.2 > Logging in to IP KVM

The default IP address is as below:

IP address: 192.168.1.22

Subnet mask: 255.255.255.0

Gateway: 192.168.1.1

IP KVM model with single IP port:

- Default address 192.168.1.22

IP KVM model with dual IP ports:

- The 1st IP address 192.168.1.22
- The 2nd IP address 192.168.1.23

To log in to the IP KVM do as follows:

1. Open the browser on the client, in the address bar, enter the default IP KVM address (192.168.1.22)

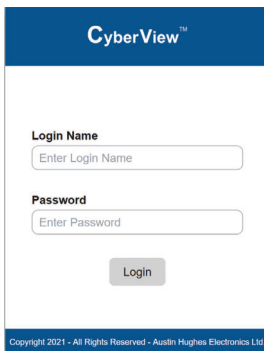

2. In login dialog box, enter the user name and password, then click **Login**, the default user name is **super** and the default password is **pass**.
3. The IP KVM GUI is displayed, and the navigation bar is on left-side.

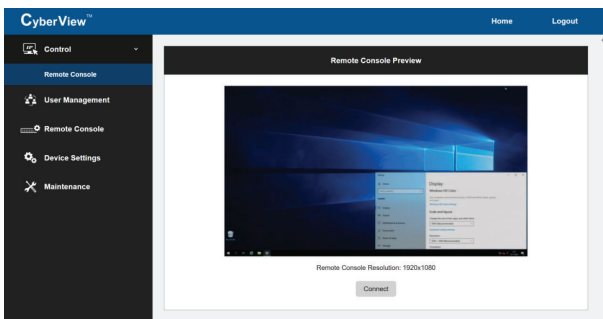

< 3.3 > Configure Remote Console Resolution

The IP remote console displayed on the HTML5-based browser support multiple types of resolution, with a maximum of 1,920 x 1,200.

Click **Remote Console** and then **Resolution**, the Remote Console Video page is displayed, select the same resolution as target servers, click **Apply** to save the resolution.

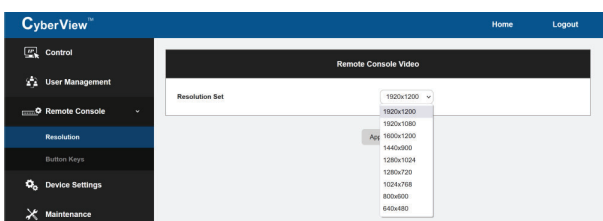

< 3.4 > Launch remote console

Click **Control** and then **Remote console**, the Remote console Preview is displayed, then Click **Connect**, the remote console opens in a separate windows.

When first start, the local mouse is not synchronized with the remote mouse, it appears at a distance to each other, press the **Mouse Sync** once (positioning top left corner), the mouse will align.

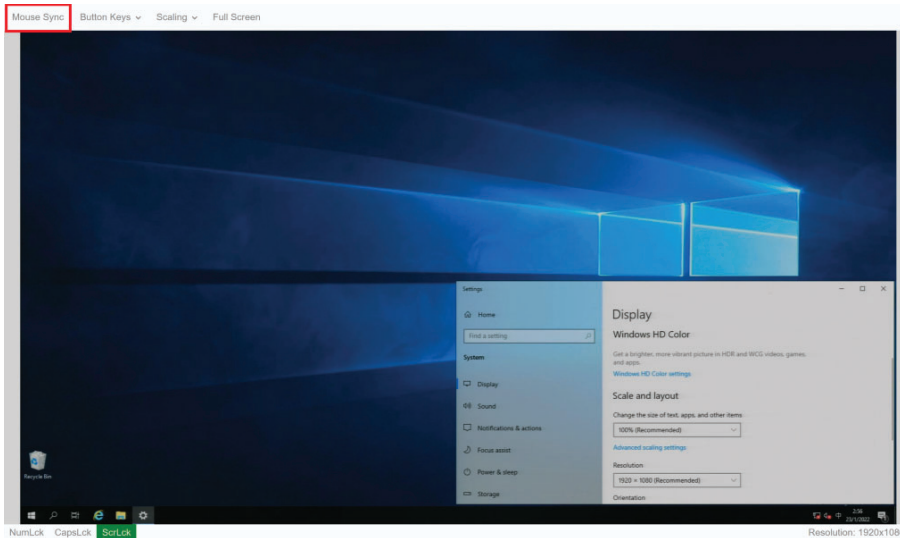

KVM Console Hotkey	Function
Scroll Lock + Scroll Lock + Space Bar	Calling OSD menu
Right-button mouse + Esc	Calling OSD menu
Scroll Lock + Scroll Lock + ↑	Switch to previous port
Scroll Lock + Scroll Lock + ↓	Switch to next port
Scroll Lock + Scroll Lock + PgUp / PgDn	Switch to previous bank or next bank
Scroll Lock + Scroll Lock + Bank no. + Port no.	Switch to specific port
Scroll Lock + Scroll Lock + B	Turn the buzzer ON and OFF * Default the buzzer is ON
Scroll Lock + Scroll Lock + P	Logout the KVM if password security is ON. Show up the status windows

Advance hotkeys (for Supervisor login only)	
Scroll Lock + Scroll Lock + S	Activate auto-scan mode for connected servers *Press any key to exit the auto-scan mode
Scroll Lock + Scroll Lock + R	Reset all the KVM settings to factory default *Except User Security settings
Scroll Lock + Scroll Lock + U	Disable and enable password security *Default security is ON
Scroll Lock + Scroll Lock + L	To enable / disable the screen saving function and 10 minutes auto-logout *Default the screen saving is OFF

- Remarks:**
- Example of "Scroll Lock + Scroll Lock + Bank no. + Port no."
 - Bank No. : 1 to 8
 - Port No. : 01 to 16
 - e.g. Bank 1 Port 4 : **Scroll Lock + Scroll Lock + 1 + 0 + 4**
 - e.g. Bank 2 Port 16 : **Scroll Lock + Scroll Lock + 2 + 1 + 6**
 - You must press the hotkey within 2 seconds
 - The numeric keypad is not supported, while in OSD screen, the arrow keys, PgUp, PgDn, and Enter keys are supports
 - For the OSD usage and password setting, please refer to the KVM user manual for details : https://www.austin-hughes.com/resource_cat/product-resources/rack-kvm-resources/

Intentionally Left Blank

The company reserves the right to modify product specifications without prior notice and assumes no responsibility for any error which may appear in this publication.

All brand names, logo and registered trademarks are properties of their respective owners.

Copyright 2022 Austin Hughes Electronics Ltd. All rights reserved.