

User Manual 17" / 19" LCD 1152 x 900 Native Resolution



SP-117 / SP-119 1U SUN LCD Drawer



Options :
- DC power



Designed and manufactured by Austin Hughes

751

Intentionally Left Blank

Legal Information

First English printing, July 2023

Information in this document has been carefully checked for accuracy; however, no guarantee is given to the correctness of the contents. The information in this document is subject to change without notice. We are not liable for any injury or loss that results from the use of this equipment.

Safety Instructions

Please read all of these instructions carefully before you use the device. Save this manual for future reference.

- Unplug equipment before cleaning. Don't use liquid or spray detergent; use a moist cloth.
- Keep equipment away from excessive humidity and heat. Preferably, keep it in an air-conditioned environment with temperatures not exceeding 40° Celsius (104° Fahrenheit).
- When installing, place the equipment on a sturdy, level surface to prevent it from accidentally falling and causing damage to other equipment or injury to persons nearby.
- When the equipment is in an open position, do not cover, block or in any way obstruct the gap between it and the power supply. Proper air convection is necessary to keep it from overheating.
- Arrange the equipment's power cord in such a way that others won't trip or fall over it.
- If you are using a power cord that didn't ship with the equipment, ensure that it is rated for the voltage and current labeled on the equipment's electrical ratings label. The voltage rating on the cord should be higher than the one listed on the equipment's ratings label.
- Observe all precautions and warnings attached to the equipment.
- If you don't intend on using the equipment for a long time, disconnect it from the power outlet to prevent being damaged by transient over-voltage.
- Keep all liquids away from the equipment to minimize the risk of accidental spillage. Liquid spilled on to the power supply or on other hardware may cause damage, fire or electrical shock.
- Only qualified service personnel should open the chassis. Opening it yourself could damage the equipment and invalidate its warranty.
- If any part of the equipment becomes damaged or stops functioning, have it checked by qualified service personnel.

What the warranty does not cover

- Any product, on which the serial number has been defaced, modified or removed.
- Damage, deterioration or malfunction resulting from:
 - Accident, misuse, neglect, fire, water, lightning, or other acts of nature, unauthorized product modification, or failure to follow instructions supplied with the product.
 - Repair or attempted repair by anyone not authorized by us.
 - Any damage of the product due to shipment.
 - Removal or installation of the product.
 - Causes external to the product, such as electric power fluctuation or failure.
 - Use of supplies or parts not meeting our specifications.
 - Normal wear and tear.
 - Any other causes which does not relate to a product defect.
- Removal, installation, and set-up service charges.

Regulatory Notices Federal Communications Commission (FCC)

This equipment has been tested and found to comply with the limits for a Class B digital device, pursuant to Part 15 of the FCC rules. These limits are designed to provide reasonable protection against harmful interference in a residential installation.

Any changes or modifications made to this equipment may void the user's authority to operate this equipment. This equipment generates, uses, and can radiate radio frequency energy and, if not installed and used in accordance with the instructions, may cause harmful interference to radio communications.

However, there is no guarantee that interference will not occur in a particular installation. If this equipment does cause harmful interference to radio or television reception, which can be determined by turning the equipment off and on, the user is encouraged to try to correct the interference by one or more of the following measures:

- Re-position or relocate the receiving antenna.
- Increase the separation between the equipment and receiver.
- Connect the equipment into an outlet on a circuit different from that to which the receiver is connected.

Contents

< Part. 1 > SP-117 / SP-119

1.1	Package Content	P.1
1.2	Structure Diagram & Dimension	P.1
1.3	Installation	P.3

< Part. 2 > Specifications / OSD

2.1	Product Specifications	P.5
2.2	On-screen Display Operation (OSD)	P.7

< Part. 3 > Options

3.1	DC Power	P.11
-----	----------	------

Before Installation

- It is very important to mount the equipment in a suitable cabinet or on a stable surface.
- Make sure the place has a good ventilation, is out of direct sunlight, away from sources of excessive dust, dirt, heat, water, moisture and vibration.

Unpacking

The equipment comes with the standard parts shown in package content. Check and make sure they are included and in good condition. If anything is missing, or damaged, contact the supplier immediately.

How To Clean Your LCD Monitor



Caution :

- To avoid the risk of electric shock, make sure your hands are dry before unplugging your monitor from or plugging your monitor into an electrical outlet.
- When you clean your monitor, do not press down on the LCD screen. Pressing down on the screen can scratch or damage your display. Pressure damage is not covered under warranty.
- Use only cleansers made specifically for cleaning monitors and monitor screens. Cleansers not made to clean monitors and monitor screens can scratch the LCD display or strip off the finish.
- Do not spray any kind of liquid directly onto the screen or case of your monitor. Spraying liquids directly onto the screen or case can cause damage which is not covered under warranty.
- Do not use paper towels or abrasive pads to clean your monitor. Using an abrasive pad or any wood based paper product such as paper towels can scratch your LCD screen.

Cleaning Your Monitor

To clean your LCD safely, please follow these steps :

- ① Disconnect the power cord.
- ② Gently wipe the surface using a clean, dry microfiber cloth. Use as little pressure as possible.

Cleaning Tough Marks and Smudges

To remove tough marks and smudges, please follow these steps :

- ① Disconnect the power cord.
- ② Spray a small amount of non-abrasive cleanser on a microfiber cloth.



Caution : Do not spray or apply any liquids directly onto the monitor. Always apply the solution to your microfiber cloth first, not directly on the parts you are cleaning.

- ③ Gently wipe the surface. Use as little pressure as possible.
- ④ Wait until your monitor is completely dry before plugging it in and powering it up.

< Part 1 >

< 1.1 > Package Content



SP-117 or SP-119 unit X 1

- 6ft VGA cable X 1
- Power cord X 1
- M6 screw, cage nut & cup washer X 8



The above package content is only for the pure model (VGA and HDMI only). It varies with options such as DC power.

< 1.2 > Structure Diagram

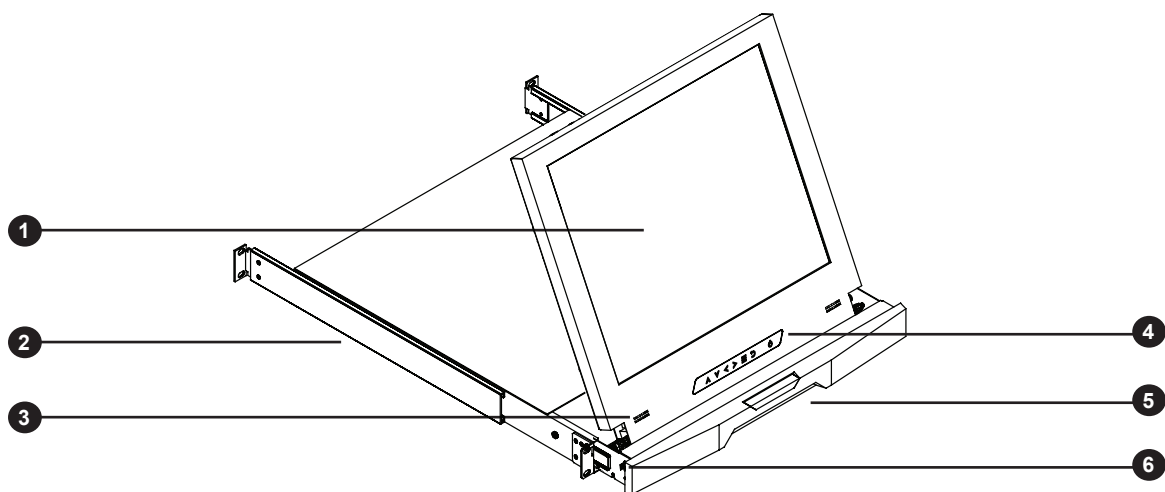

- ① LCD panel
- ② Installation Slide
- ③ Audio speaker (optional)

- ④ LCD OSD membrane
- ⑤ Carry handle to release the 2-pt lock
- ⑥ 2-point lock



Front View

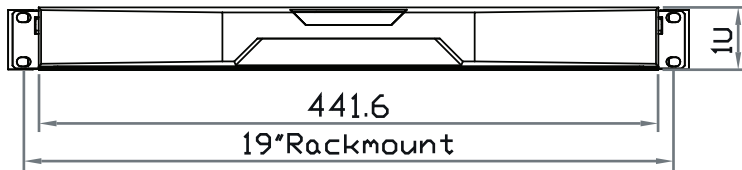

Rear View

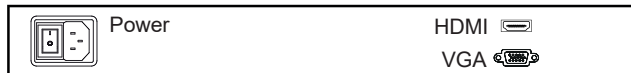

Side View

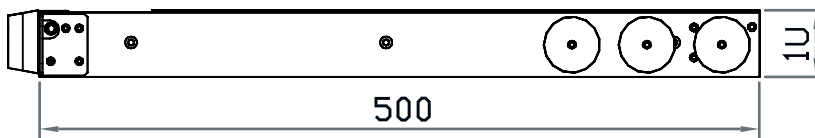

UNIT : mm
1mm = 0.03937 inch

Top View

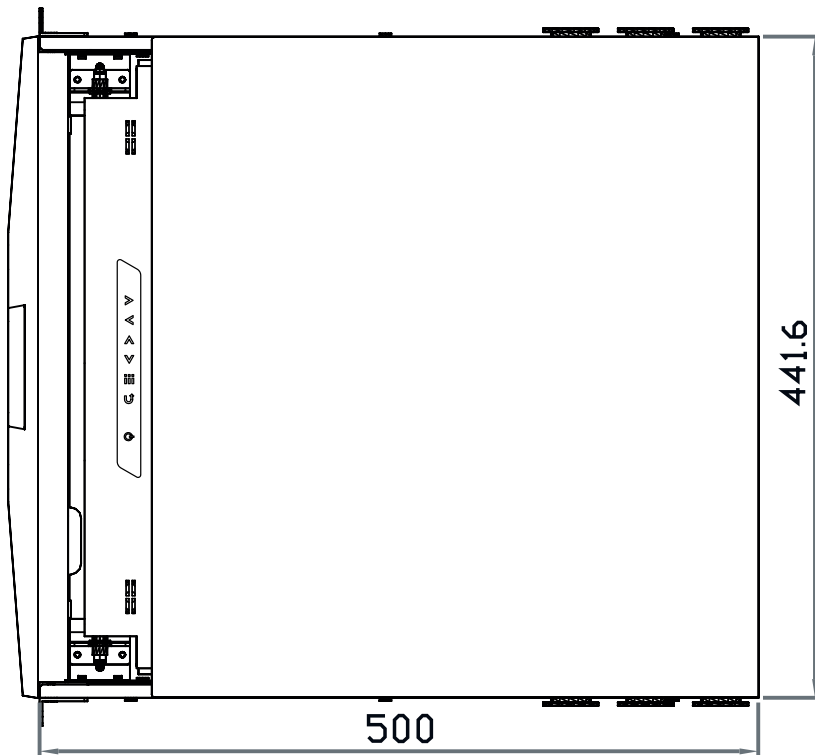

Model	Product Dimension (W x D x H)	Packing Dimension (W x D x H)	Net Weight	Gross Weight
SP-117 series	441.6 x 500 x 44 mm 17.4 x 19.7 x 1.73 inch	588 x 758 x 120 mm 23.1 x 29.8 x 4.7 inch	10.5 kg 23.1 lb	16.5 kg 36.3 lb
SP-119 series	441.6 x 500 x 44 mm 17.4 x 19.7 x 1.73 inch	588 x 758 x 120 mm 23.1 x 29.8 x 4.7 inch	12.5 kg 27.5 lb	18.5 kg 40.7 lb

 The weight is only for the pure models. It varies with accessories & options such as DC power.

< 1.3 > Installation - How to install Installation Slides

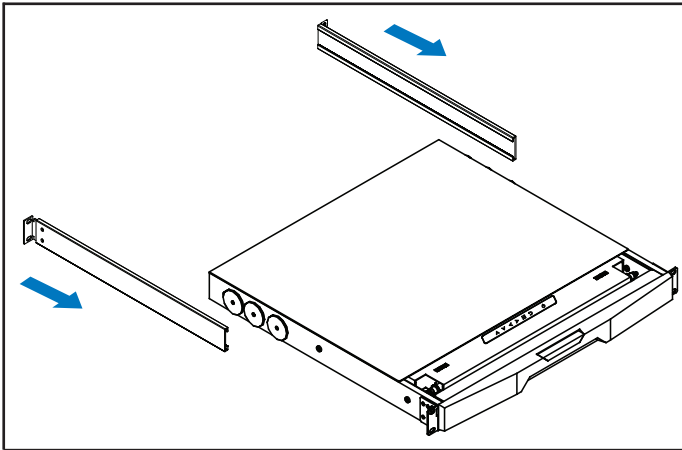

Step 1

- Insert the left and right rear mounting brackets into the display drawer.

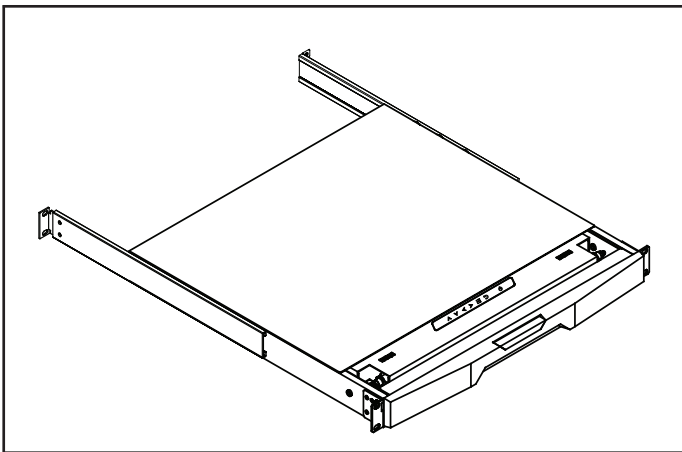

Step 2

- Measure the depth of the front and rear mounting rails.
- Align each rear mounting bracket to a suitable length.

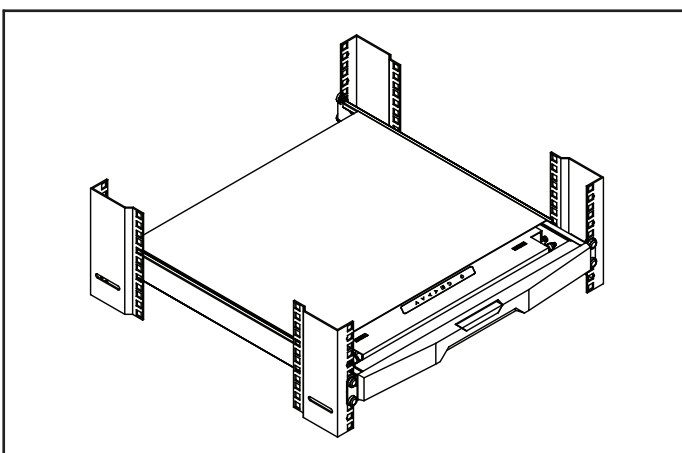

Step 3

Complete the installation

- Fix the display drawer into the rack.

 M6 screw, cage nut & cup washer x 8 are provided.



After use the drawer

Basically, user can push in the drawer back to park position by releasing the left & right slide lock arrow (as long as the drawer starts moving, he/she can release their finger right away, holding the arrow is not necessary).

Intentionally Left Blank

< Part 2 >

< 2.1 > Product Specifications

LCD Panel		SP-117	SP-119
	Manufacturer	AUO	AUO
	Panel Size (diagonal)	17-inch TFT color LCD	19-inch TFT color LCD
	Display pixel (dots x lines)	1152 x 900 (Direct)	1152 x 900 (Direct)
		1280 x 1024 (Native)	1280 x 1024 (Native)
	Brightness (typ.)	250	250
	Contrast Ratio (typ.)	1000:1	1000:1
	Color	16.7 M	16.7 M
	Viewing Angle (L/R/U/D)	85/85/80/80	85/85/80/80
	Response Time (ms)	5	5
	Dot pitch (mm)	0.264	0.294
	Display Area (mm)	337.92H x 270.33V	376.32H x 301.06V
	Surface treatment	Haze 25%, Hard-coating	
	Surface hardness	3H	3H
Backlight Type	LED	LED	
MTBF (hrs)	30,000	30,000	

Video Connectivity	Digital	HDMI	HDMI 1.4, HDCP 1.4
	Analog	VGA	Analog 0.7Vp-p
	Plug & Play	DVI / VGA	VESA EDID structure 1.3
	Synchronization	VGA	Separate, Composite & SOG

Power	Power Supply	Range	Auto-sensing 100 to 240VAC, 50 / 60Hz
	Power Consumption	Screen ON	Max. 22W
		Power saving mode	Max. 2W
		Power button OFF	Max. 1W

Compliance	EMC	FCC & CE
	Safety	CE / LVD & UKCA
	Environmental	RoHS3 & REACH / WEEE

Environmental Conditions	Operating	Temperature	0 to 55°C degree
		Humidity	10~90%, non-condensing
		Altitude	16,000 ft
	Storage / Non-operating	Temperature	-20 to 60°C degree
		Humidity	5~90%, non-condensing
		Altitude	40,000 ft
		Shock	10G acceleration (11ms duration)
		Vibration	10~300Hz 0.5G RMS random





Physical Specification		SP-117	SP-119
	Product (W x D x H)	441.6 x 500 x 44 mm 17.4 x 19.7 x 1.73 inch	441.6 x 500 x 44 mm 17.4 x 19.7 x 1.73 inch
	Packing (W x D x H)	588 x 758 x 120 mm 23.1 x 29.8 x 4.7 inch	588 x 758 x 120 mm 23.1 x 29.8 x 4.7 inch
	Net Weight	10.5 kg / 23.1 lb	12.5 kg / 27.5 lb
	Gross Weight	16.5 kg / 36.3 lb	18.5 kg / 40.7 lb

* All dimensions stated are subject to change if options are selected / integrated to base model part codes

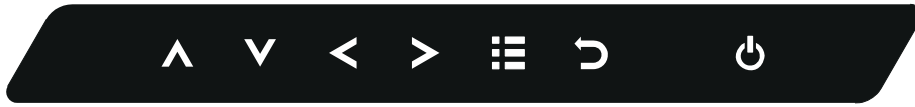
Applicable Format	DVI-D / VGA Input	PC Signal	1152 x 900 x 66Hz
			1280 x 1024 x 60 / 75Hz
			1280 x 960 x 60Hz
			1280 x 768 x 60 / 75Hz
			1152 x 864 x 75Hz
			1024 x 768 x 60 / 70 / 75Hz
			848 x 480 x 60Hz
			800 x 600 x 60 / 72 / 75Hz
			720 x 400 x 70Hz
			640 x 480 x 60 / 72 / 75Hz
	640 x 400 x 70Hz		
	640 x 350 x 70Hz		
	HDMI Input	PC Signal	Same as VGA
		Video Signal	720p: 50 / 60Hz
			480p: 60Hz
576p: 50Hz			
Audio Signal		2ch Linear PCM (32 / 44.1 / 48 KHz)	



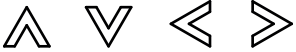



< 2.2 > On-screen Display Operation (OSD)



Membrane Switch	Function
	Turn the monitor on or off
	Display the OSD menu Act as an Enter key to select screen setting options
	Scroll through menu options and adjust the displayed control
	Exit the OSD screen Go back to the previous on-screen sub-menu or main menu

Remark : All LED touch buttons in **WHITE** light.

The LED of **Power**  touch button will flash continuously when there is no signal input.

- ① All the LED touch buttons will automatically turn off after 10 minutes of idle status (except the **Power** ).
- ② Light up all membrane buttons, please press any button for 1 - 2 seconds (except the **Power** ).
- ③ Select another video input (only available for models with multiple video input) :
 - (a) Press the button  to call up the on-screen video mode on top right corner.
 - (b) Use up/down arrow   to the select the video input
 - (c) Press the button  to confirm the selection

Intentionally Left Blank

< 2.2 > On-screen Display Operation (OSD)

① Picture

Brightness : Adjust the screen brightness

Contrast : Adjust the difference between the image background (black level) and the foreground (white level)

Black level : Adjust background black level of the screen

Eco : Screen in power saving mode

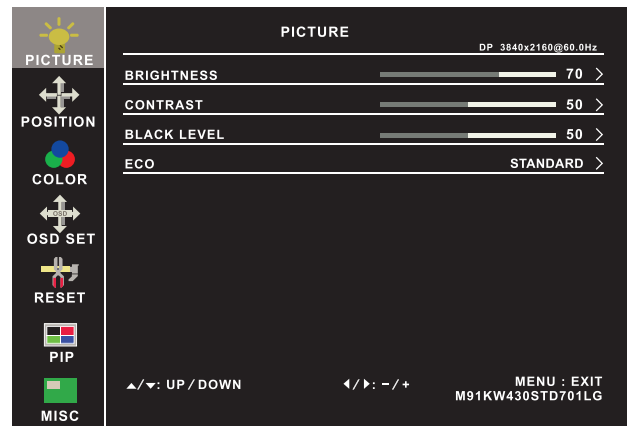

② Position

Picture size : Adjust the image size
- Full Screen / 4:3 / 5:4 / Pixel to Pixel

DP version : Select the DP version

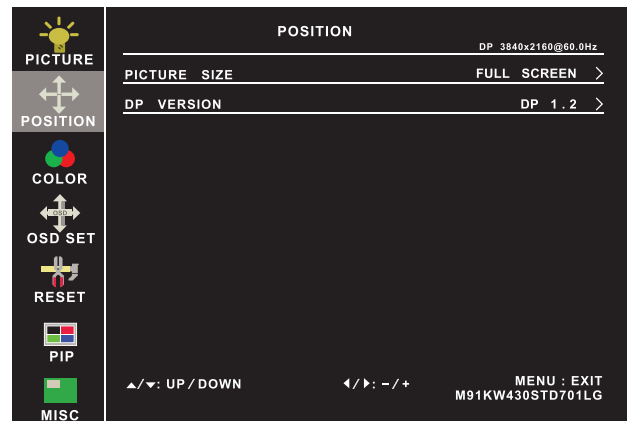

③ Color

Color temperature : User / Warm / Cool / 5400k mode and Red / Green / Blue color balance

Sharpness : Adjust the image from weak to sharp

Hue : Adjust the screen hue value

Saturation : Adjust the saturation of the image color

Dynamic

luminous control : Control the dynamic brightness

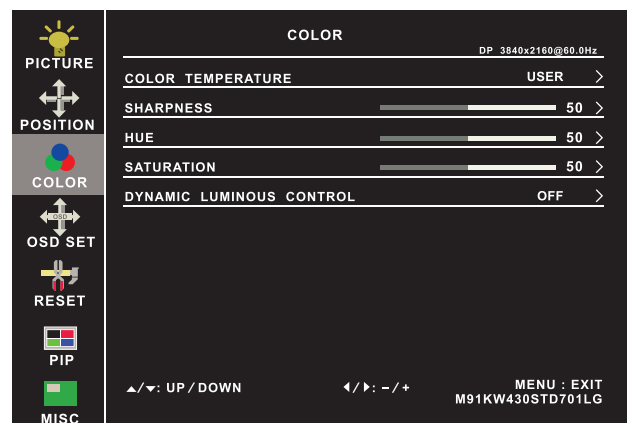

④ OSD Set

Language : Select the language in which the OSD menu is displayed - English

OSD H-Position : Align the screen image left or right

OSD V-Position : Align the screen image up or down

OSD time out : Adjust the screen timeout

OSD transparency : Adjust the screen transparency

OSD size : Adjust the screen size - Normal / Small

OSD rotation : Rotate the screen - 90° / 180° / 270°

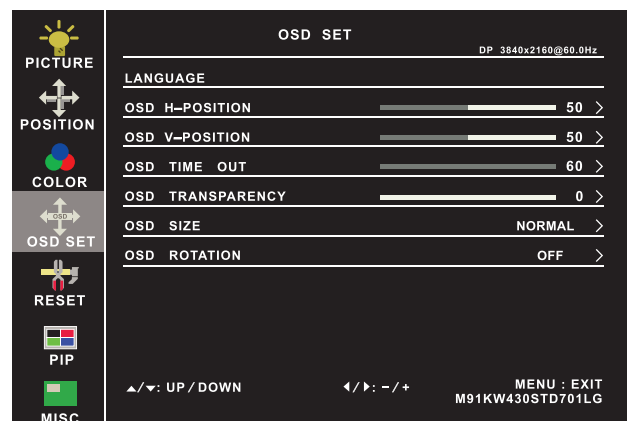

5 Reset

Reset : Return the adjustment back to factory setting

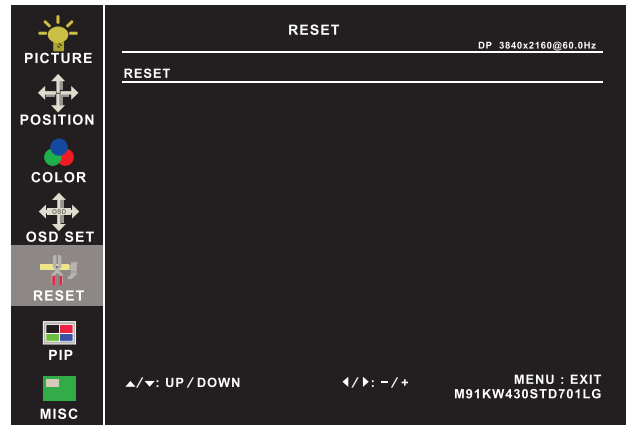

6 PIP (Not Applicable to F17 / MF17)

PIP mode : Enter into PIP / PBP setting - PIP MODE / PBP 2WIN (Main screen + 1 sub screen) / PBP 3WIN (Main screen + 2 sub screen) / PBP 4WIN (Main screen + 3 sub screen)
Select the signal input of each sub screen

PIP size : Adjust the size of the Sub screen
- Small / Medium / Large / Huge

PIP position : Adjust the position of the Sub screen
- Top Left / Top Right / Bottom Left / Bottom Right

Swap : Swap the input signal of PIP / PBP sub screen

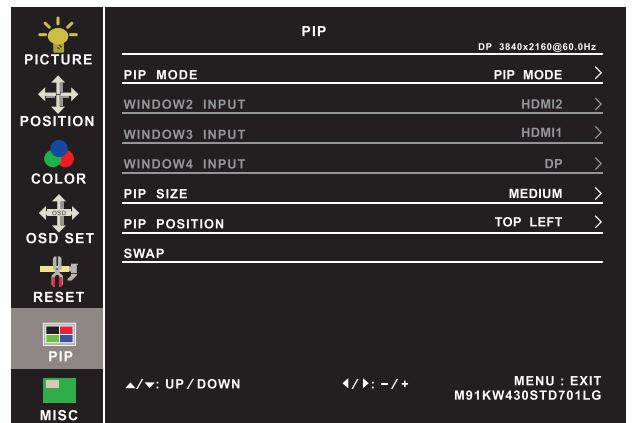

7 MISC

Signal source : Select the signal source - DP / HDMI1 / HDMI2

Mute : Turn off the surrounding sound

Audio in : Auto / Line in / DP

Volume : Adjust the volume of sound

Sleep mode : Set the off time - 10 min / 20 min / 30 min / 50 min / 60 min / 120 min / 240 min

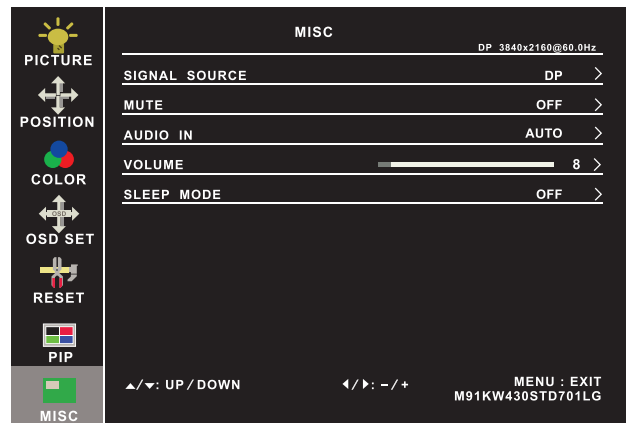

Options on Reset page

Rotation : Rotate the image in Full screen or 1:1
- 90° / 180° / 270°

Picture size : Adjust the image size in Full screen or 1:1

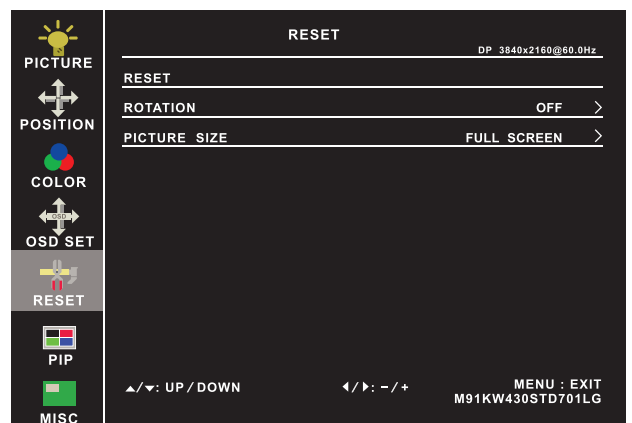

< Part 3 >

< 3.1 > Options : DC Power

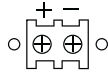

Model	12V	24V	48V	125V	250V
Input rating					
Input voltage:	12-Volt	24-Volt	48-Volt	110-Volt	300-Volt
Input range:	9 ~ 18V	18 ~ 36V	36 ~ 75V	66 ~ 160V	180 ~ 425V
Input current					
- No load	50 mA	50 mA	50 mA	35 mA	10 mA
- Full load	4950 mA	2450 mA	1220 mA	749 mA	600 mA
Output rating					
Output voltage:	12-Volt	12-Volt	12-Volt	12-Volt	12-Volt
Output current:	4.16A	4.16A	4.16A	6.25A	12.5A
Efficiency	84%	85%	85%	91%	86%

DC power



*** For DC power option :

- (1) If the unit with LCD, **earthing** may be required
- (2) DC option excludes AC power adapter and power cord.
- (3) Chassis extension in depth to 570mm (22.4")

The company reserves the right to modify product specifications without prior notice and assumes no responsibility for any error which may appear in this publication.

All brand names, logo and registered trademarks are properties of their respective owners.
Copyright 2023 Austin Hughes Electronics Ltd. All rights reserved.