

## User Manual 21.5" FHD 1920 x 1080 LCD



**AP-F21 / HAP-F21**

Aluminum front bezel



**NAP-F21 / HNAP-F21**

Front NEMA4 / IP65

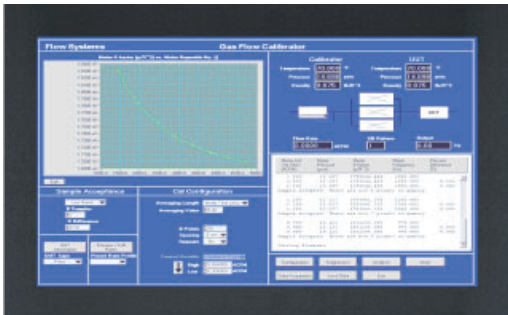

**DP-F21 / HDP-F21**

Aluminum Front Panel



**OP-F21 / HOP-F21**

Universal Open Frame



REACH

Designed and manufactured by Austin Hughes

## Legal Information

First English printing, July 2022

Information in this document has been carefully checked for accuracy; however, no guarantee is given to the correctness of the contents. The information in this document is subject to change without notice. We are not liable for any injury or loss that results from the use of this equipment.

## Safety Instructions

**Please read all of these instructions carefully before you use the device. Save this manual for future reference.**

- Unplug equipment before cleaning. Don't use liquid or spray detergent; use a moist cloth.
- Keep equipment away from excessive humidity and heat. Preferably, keep it in an air-conditioned environment with temperatures not exceeding 40° Celsius (104° Fahrenheit).
- When installing, place the equipment on a sturdy, level surface to prevent it from accidentally falling and causing damage to other equipment or injury to persons nearby.
- When the equipment is in an open position, do not cover, block or in any way obstruct the gap between it and the power supply. Proper air convection is necessary to keep it from overheating.
- Arrange the equipment's power cord in such a way that others won't trip or fall over it.
- If you are using a power cord that didn't ship with the equipment, ensure that it is rated for the voltage and current labeled on the equipment's electrical ratings label. The voltage rating on the cord should be higher than the one listed on the equipment's ratings label.
- Observe all precautions and warnings attached to the equipment.
- If you don't intend on using the equipment for a long time, disconnect it from the power outlet to prevent being damaged by transient over-voltage.
- Keep all liquids away from the equipment to minimize the risk of accidental spillage. Liquid spilled on to the power supply or on other hardware may cause damage, fire or electrical shock.
- Only qualified service personnel should open the chassis. Opening it yourself could damage the equipment and invalidate its warranty.
- If any part of the equipment becomes damaged or stops functioning, have it checked by qualified service personnel.

## What the warranty does not cover

- Any product, on which the serial number has been defaced, modified or removed.
- Damage, deterioration or malfunction resulting from:
  - Accident, misuse, neglect, fire, water, lightning, or other acts of nature, unauthorized product modification, or failure to follow instructions supplied with the product.
  - Repair or attempted repair by anyone not authorized by us.
  - Any damage of the product due to shipment.
  - Removal or installation of the product.
  - Causes external to the product, such as electric power fluctuation or failure.
  - Use of supplies or parts not meeting our specifications.
  - Normal wear and tear.
  - Any other causes which does not relate to a product defect.
- Removal, installation, and set-up service charges.

## Regulatory Notices Federal Communications Commission (FCC)

This equipment has been tested and found to comply with the limits for a Class B digital device, pursuant to Part 15 of the FCC rules. These limits are designed to provide reasonable protection against harmful interference in a residential installation.

Any changes or modifications made to this equipment may void the user's authority to operate this equipment. This equipment generates, uses, and can radiate radio frequency energy and, if not installed and used in accordance with the instructions, may cause harmful interference to radio communications.

However, there is no guarantee that interference will not occur in a particular installation. If this equipment does cause harmful interference to radio or television reception, which can be determined by turning the equipment off and on, the user is encouraged to try to correct the interference by one or more of the following measures:

- Re-position or relocate the receiving antenna.
- Increase the separation between the equipment and receiver.
- Connect the equipment into an outlet on a circuit different from that to which the receiver is connected.

# Contents

## < Part. 1 > AP-F21 / NAP-F21 / HAP-F21 / HNAP-F21

1.1	Package Content	P.1
1.2	Structure Diagram & Dimension	P.2
1.3	Mounting Hardware & Installation	P.4

## < Part. 2 > DP-F21 / HDP-F21

2.1	Package Content	P.5
2.2	Structure Diagram & Dimension	P.6
2.3	Mounting Hardware & Installation	P.8

## < Part. 3 > OP-F21 / HOP-F21

3.1	Package Content	P.9
3.2	Structure Diagram & Dimension	P.10
3.3	Mounting Hardware & Installation	P.12

## < Part. 4 > Specifications / OSD

4.1	Product Specifications	P.14
4.2	On-screen Display Operation ( OSD )	P.16

## < Part. 5 > Options

5.1	Option Table	P.18
5.2	3G / HD / SD- <b>SDI</b> Broadcast-grade input	P.19
5.3	<b>MCS</b> Multi-display control solution	P.20
5.4	Upgrade : HDMI, DP & Audio	P.21
5.5	Projected Capacitive ( 10-point touch ) Resistive / Capacitive ( 1-point touch )	P.23
5.6	DC Power : 12V / 24V / 48V / 125V	P.25
5.7	MIL-type or lockable connector	P.26
5.8	Quad display for CCTV	P.27
5.9	Options for Sunlight Readable : Auto Dimming	P.28

## < Part. 6 > Ultraview Family

6.1	F21	P.29
-----	-----	------

## Before Installation

- It is very important to mount the equipment in a suitable cabinet or on a stable surface.
- Make sure the place has a good ventilation, is out of direct sunlight, away from sources of excessive dust, dirt, heat, water, moisture and vibration.

## Unpacking

The equipment comes with the standard parts shown in package content. Check and make sure they are included and in good condition. If anything is missing, or damaged, contact the supplier immediately.

## How To Clean Your LCD Monitor



### Caution :

- To avoid the risk of electric shock, make sure your hands are dry before unplugging your monitor from or plugging your monitor into an electrical outlet.
- When you clean your monitor, do not press down on the LCD screen. Pressing down on the screen can scratch or damage your display. Pressure damage is not covered under warranty.
- Use only cleansers made specifically for cleaning monitors and monitor screens. Cleansers not made to clean monitors and monitor screens can scratch the LCD display or strip off the finish.
- Do not spray any kind of liquid directly onto the screen or case of your monitor. Spraying liquids directly onto the screen or case can cause damage which is not covered under warranty.
- Do not use paper towels or abrasive pads to clean your monitor. Using an abrasive pad or any wood based paper product such as paper towels can scratch your LCD screen.

## Cleaning Your Monitor

To clean your LCD safely, please follow these steps :

Disconnect the power cord.

Gently wipe the surface using a clean, dry microfiber cloth. Use as little pressure as possible.

## Cleaning Tough Marks and Smudges

To remove tough marks and smudges, please follow these steps :

Disconnect the power cord.

Spray a small amount of non-abrasive cleanser on a microfiber cloth.

**Caution : Do not spray or apply any liquids directly onto the monitor. Always apply the solution to your microfiber cloth first, not directly on the parts you are cleaning.**

Gently wipe the surface. Use as little pressure as possible.

Wait until your monitor is completely dry before plugging it in and powering it up.

**AP-F21 / NAP-F21 /  
HAP-F21 / HNAP-F21**



**21.5" FHD LCD display X 1**

**6ft VGA cable X 1**

**Power adapter X 1**

**Power cord X 1**

**Mounting hardware X 1 pack**

- Mounting bracket x 4 pcs

- M4\* 6mm screw x 8 pcs

- M4\* 50mm screw x 8 pcs

**Basic I/O**

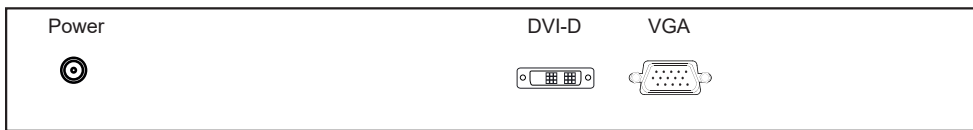

**Upgrade I/O with advanced features**

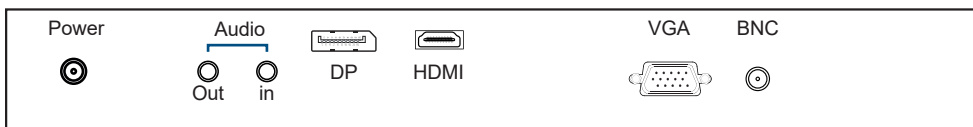

## < 1.2 > Structure Diagram

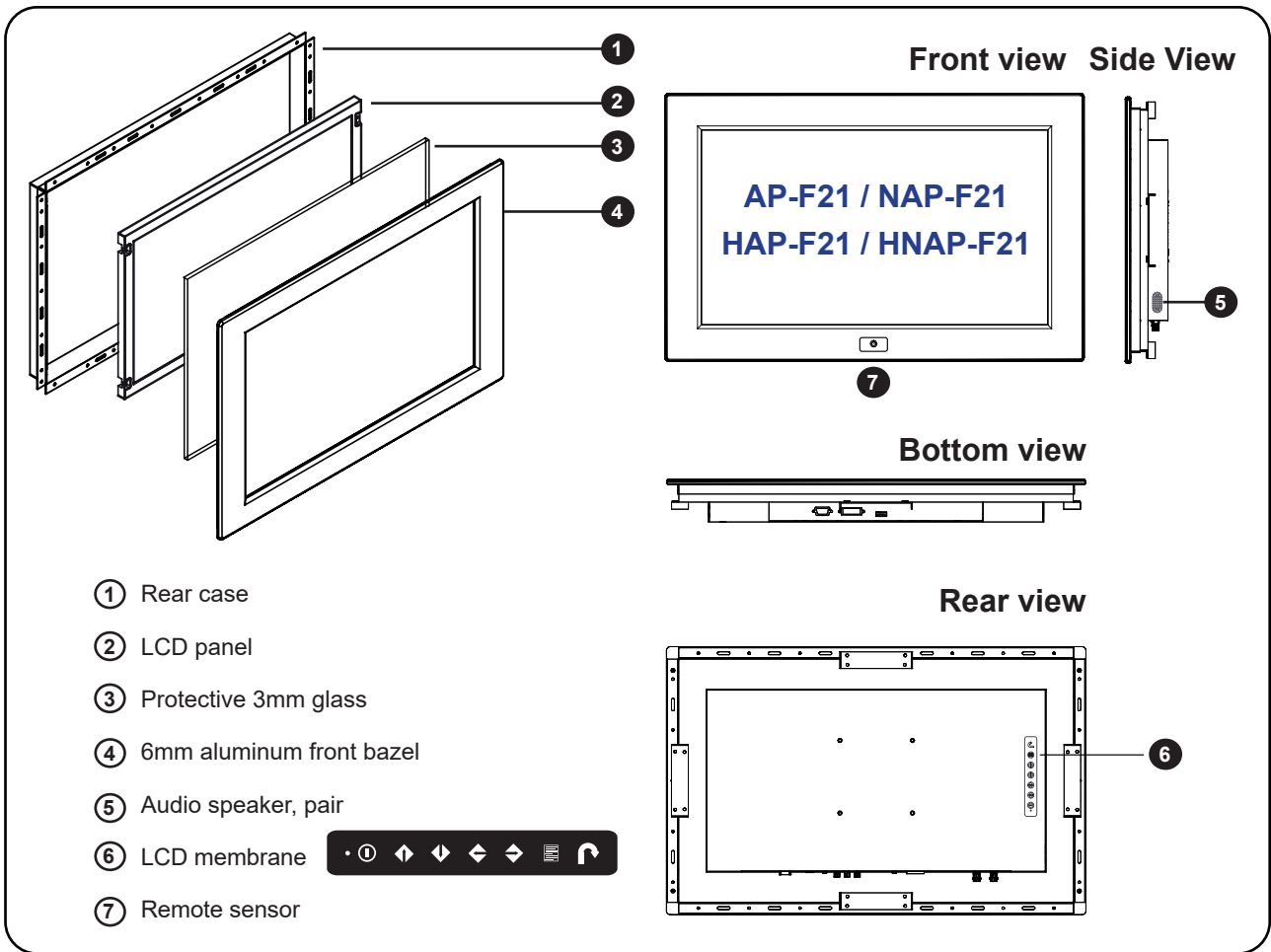

Model	Product Dimension (W x D x H)	Packing Dimension (W x D x H)	Net Weight	Gross Weight
AP-F21 NAP-F21 HAP-F21 HNAP-F21	577.8 x 59.1 x 369.3 mm 22.7 x 2.3 x 14.5 inch	659 x 117 x 640 mm 25.9 x 4.6 x 25.2 inch	9 kg 19.8 lb	12.7 kg 27.9 lb

< 1.2 > Dimension

21.5" FHD LCD Display

Front View

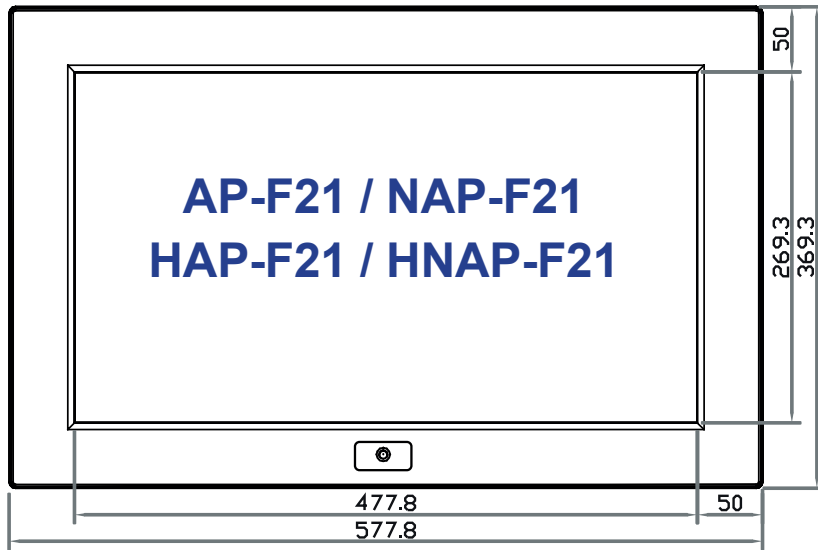

Side View

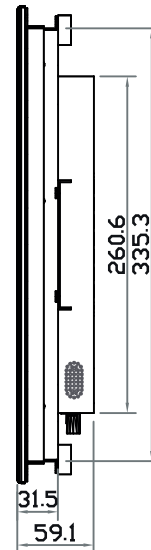

Rear View

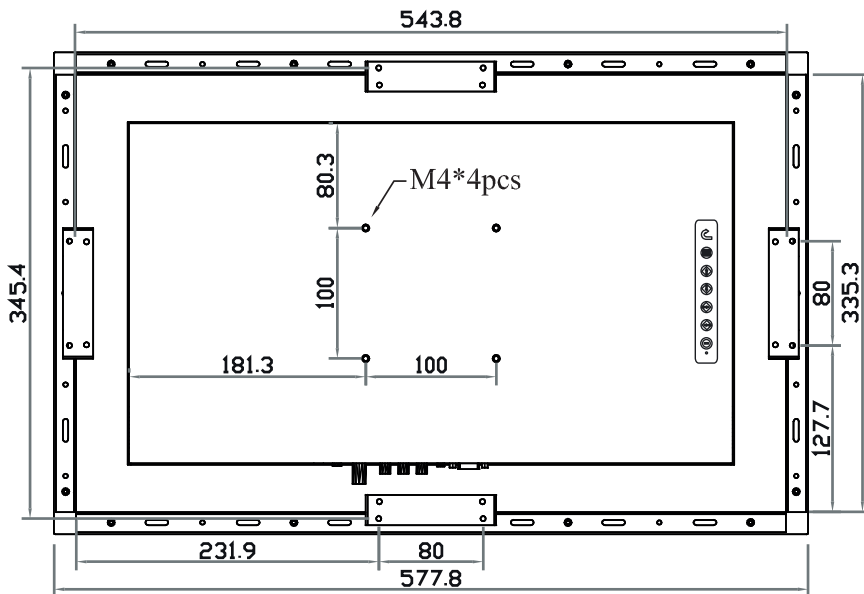

UNIT : mm  
1mm = 0.03937 inch

Bottom View

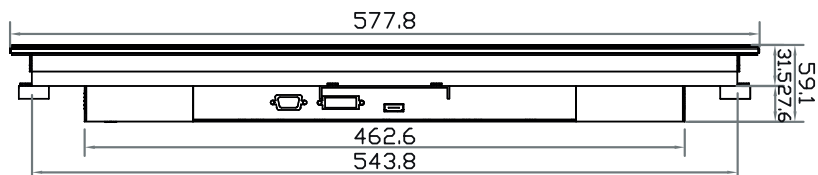

## < 1.3 > Installation ( I ) Panel mount

- 1 Mounting bracket  
x 4 pcs



- 2 M4\*6mm screw  
x 8 pcs



- 3 M4\*50mm screw  
x 8 pcs

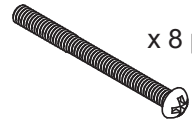

Hardware set part no. UV-BK#2

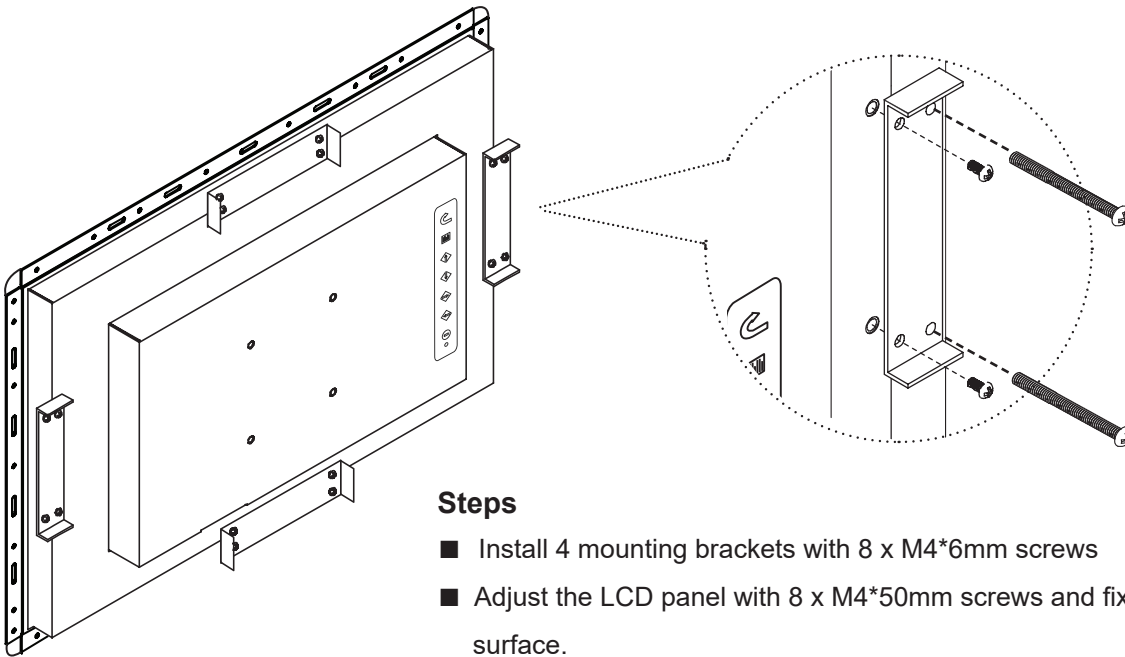

### Steps

- Install 4 mounting brackets with 8 x M4\*6mm screws
- Adjust the LCD panel with 8 x M4\*50mm screws and fix it on the surface.

## ( II ) VESA mount ( 100\*100mm )

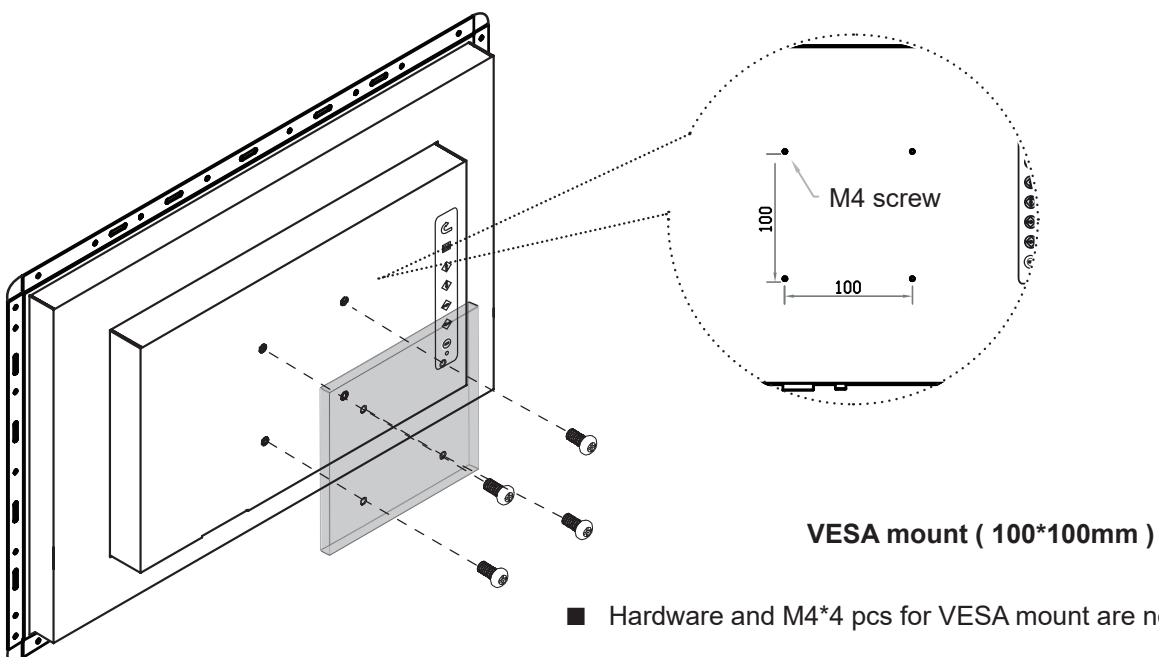

- Hardware and M4\*4 pcs for VESA mount are not provided



**DP-F21 / HDP-F21**

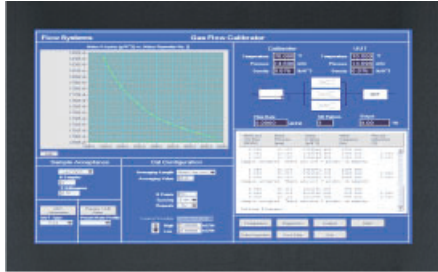

- 21.5" FHD LCD display X 1
- 6ft VGA cable X 1
- Power adapter X 1
- Power cord X 1

**Basic I/O**

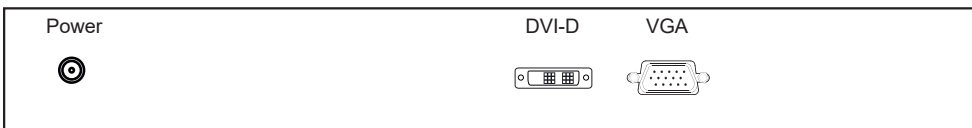

**Upgrade I/O with advanced features**

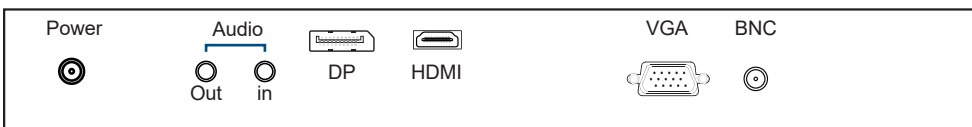

## < 2.2 > Structure Diagram

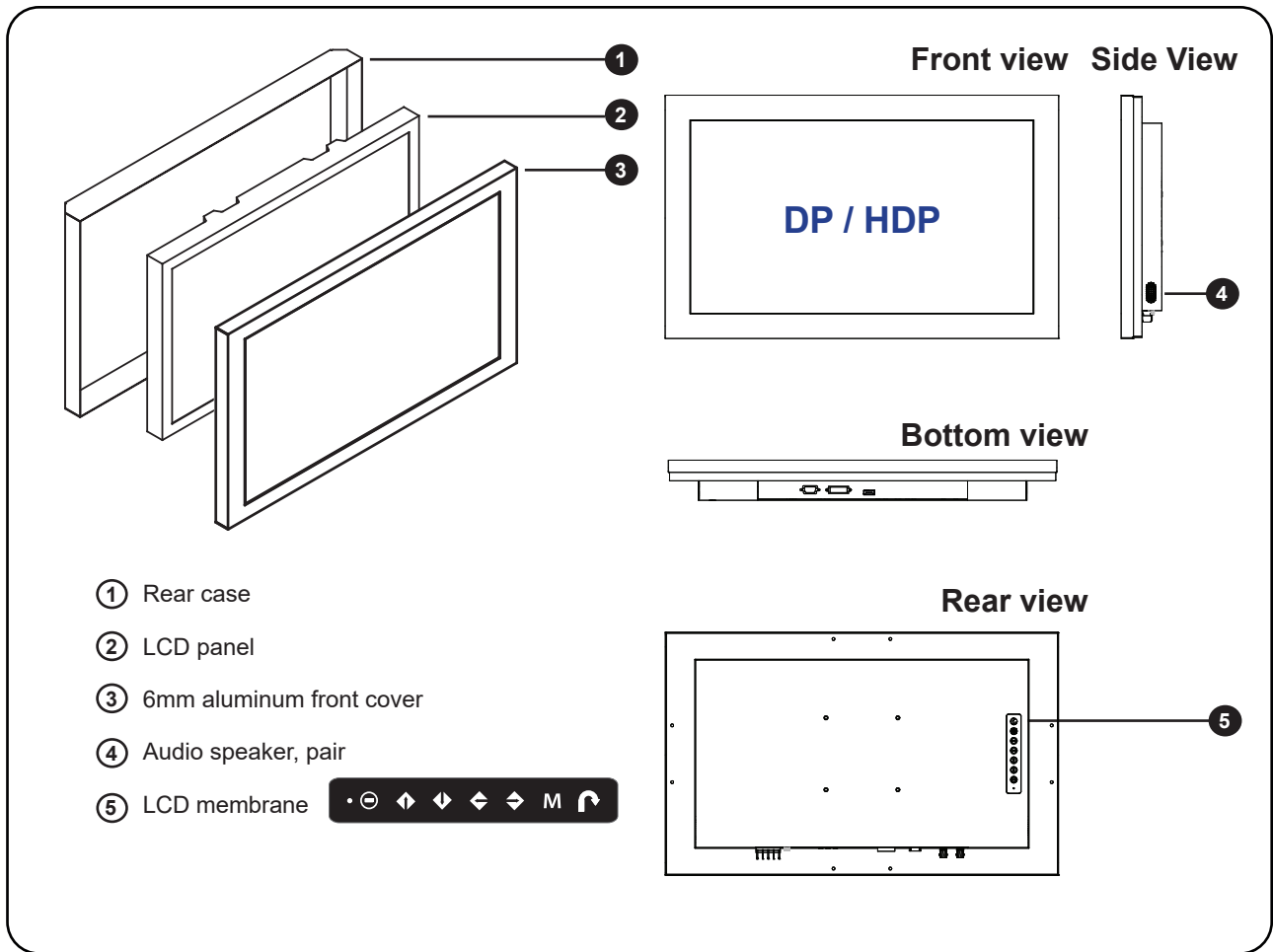

Model	Product Dimension (W x D x H)	Packing Dimension (W x D x H)	Net Weight	Gross Weight
<b>DP-F21</b> <b>HDP-F21</b>	546.8 x 56.4 x 338.3 mm 21.5 x 2.2 x 14.5 inch	659 x 117 x 640 mm 25.9 x 4.6 x 25.2 inch	7.9 kg 17.4 lb	11.6 kg 25.5 lb

Front View

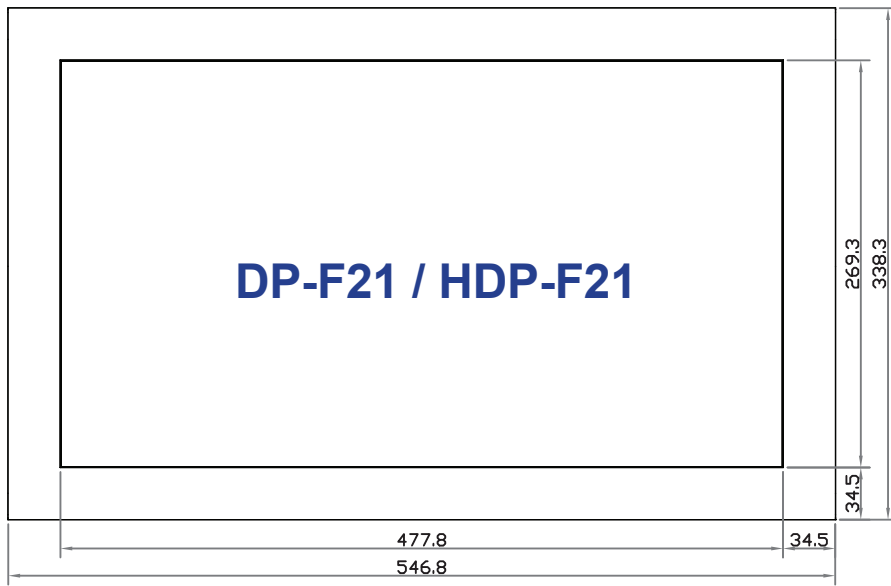

Side View



Rear View

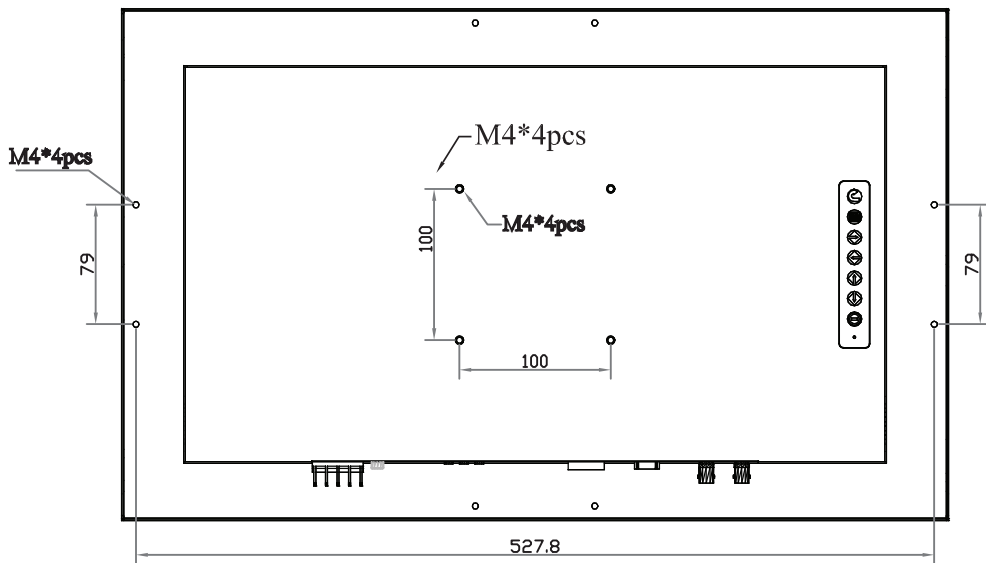

UNIT : mm  
1mm = 0.03937 inch

Bottom View

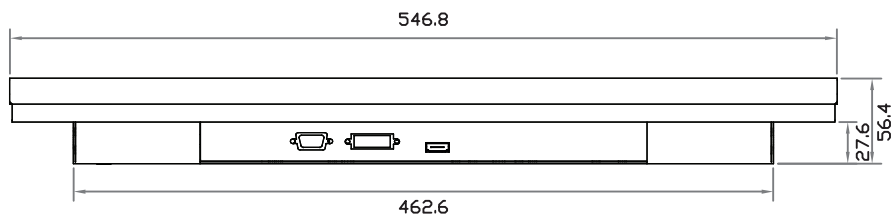

## < 2.3 > VESA mount Installation

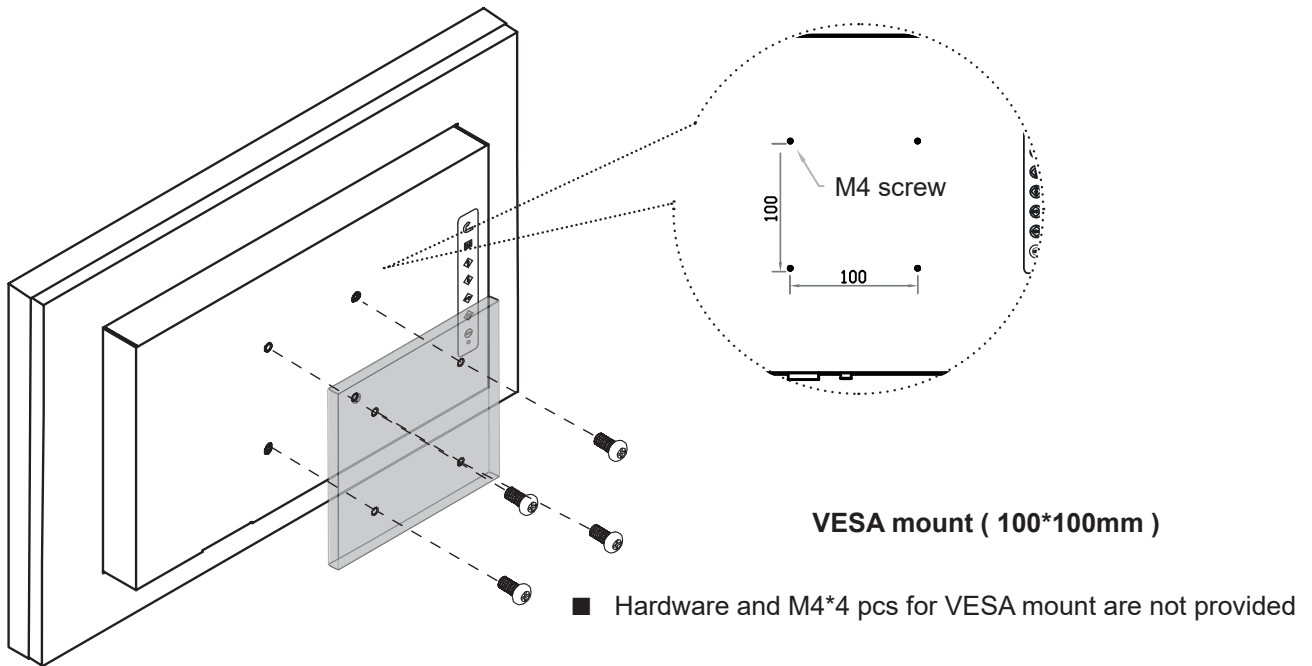

**OP-F21 / HOP-F21**



- 21.5" FHD LCD display X 1
- 6ft VGA cable X 1
- Power adapter X 1
- Power cord X 1

**Basic I/O**

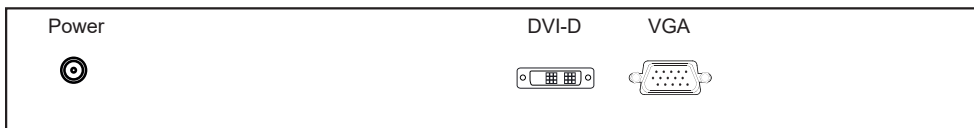

**Upgrade I/O with advanced features**

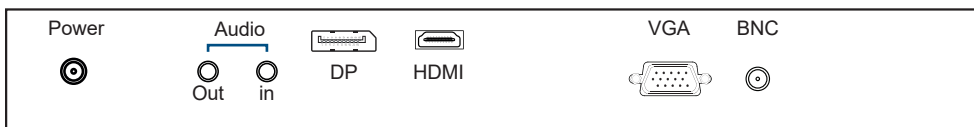

## < 3.2 > Structure Diagram

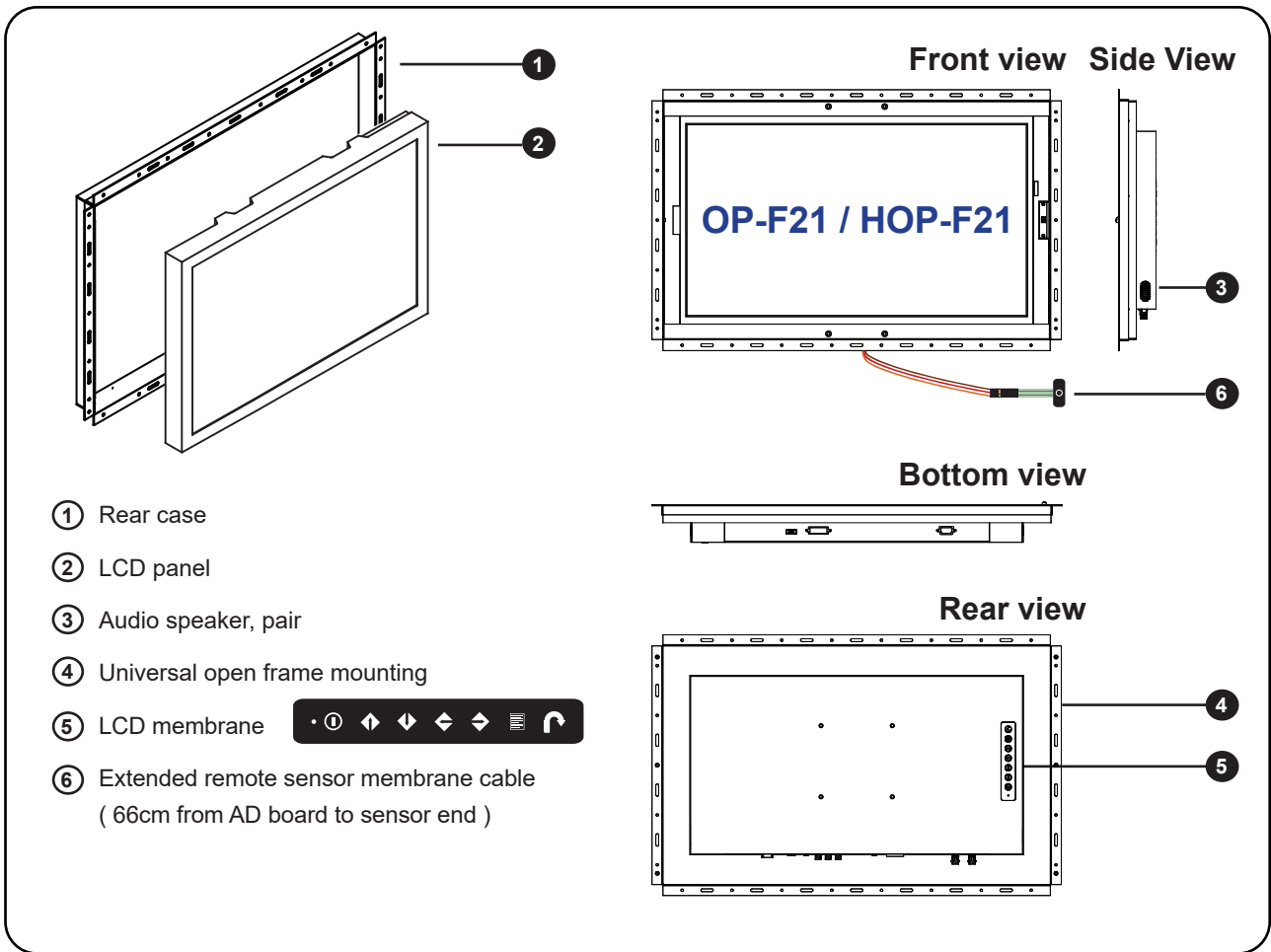

Model	Product Dimension (W x D x H)	Packing Dimension (W x D x H)	Net Weight	Gross Weight
<b>OP-F21</b> <b>HOP-F21</b>	574.8 x 52.6 x 366.3 mm 22.6 x 2.1 x 14.4 inch	659 x 117 x 640 mm 25.9 x 4.6 x 25.2 inch	6.7 kg 14.7 lb	10.4 kg 22.9 lb

< 3.2 > Dimension

21.5" FHD LCD Display

Front View

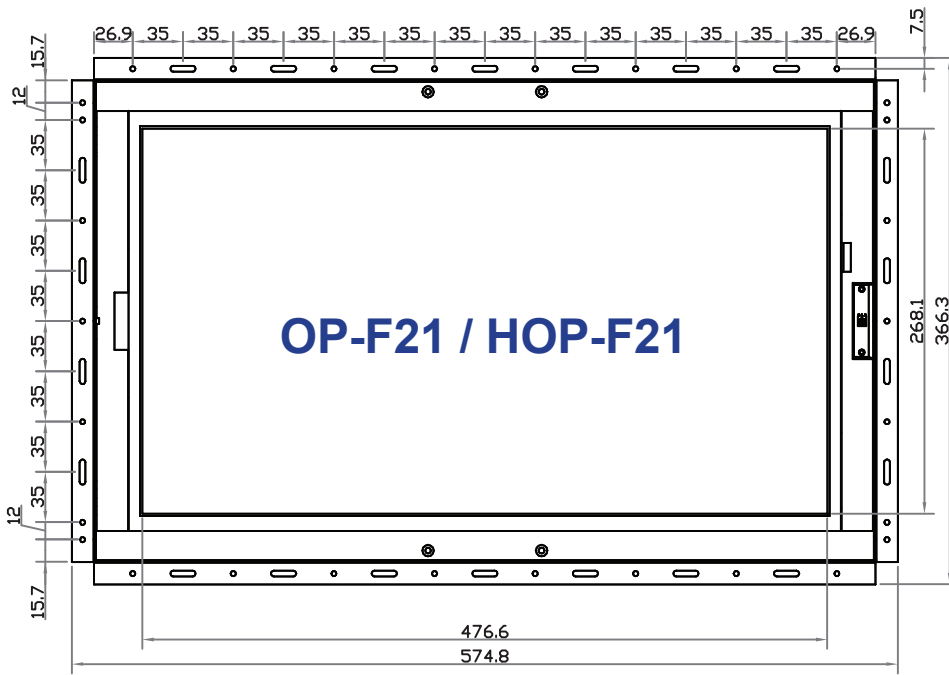

Side View

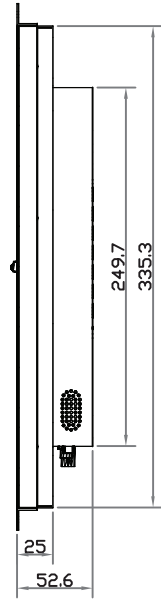

Rear View

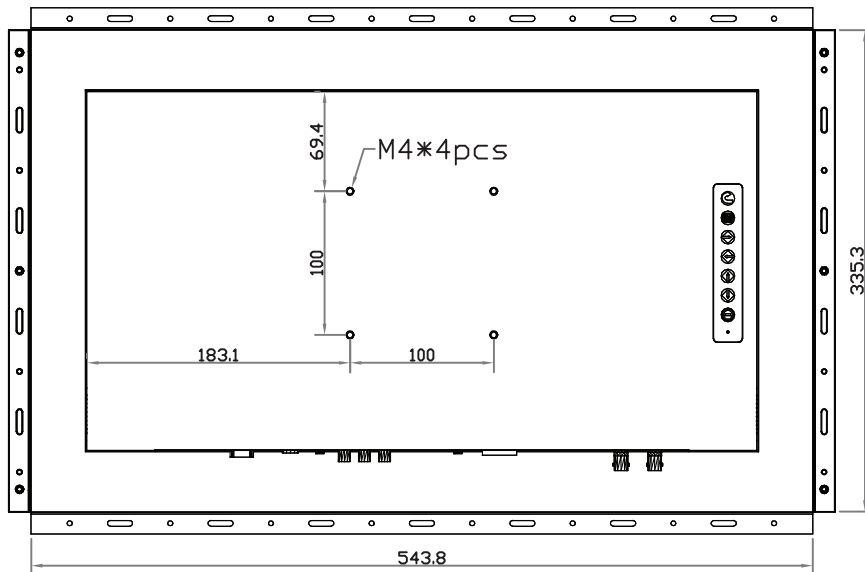

UNIT : mm  
1mm = 0.03937 inch

Bottom View

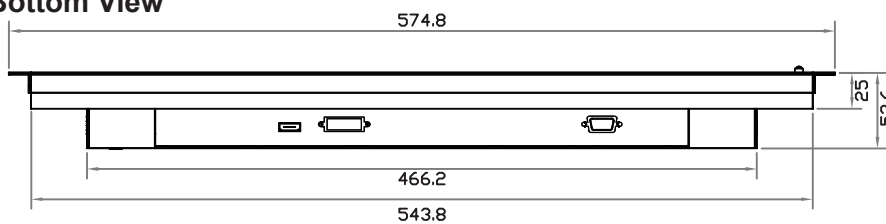





# Intentionally Left Blank

## < Part 4 >

### < 4.1 > Product Specifications

Mechanical Design	AP-F21 / HAP-F21	NAP-F21 / HNAP-F21	DP-F21 / HDP-F21	OP-F21 / HOP-F21
Protection	6mm front bezel	NEMA 4 / IP65	front cover	open frame
Front Panel	Black, RAL 9005			-
Rear Casing	Black, RAL 9005			
VESA mount	100 x 100 mm			
Universal mount	-	-	-	ready
Desktop stand	option	option	option	-
Panel mount	bundled	-	-	-

LCD Panel	Standard	Sunlight Readable
Brightness ( cd/m <sup>2</sup> )	250	1000 <sup>***</sup>
Contrast Ratio ( typ. )	1000 : 1	5000 : 1
MTBF ( hrs )	30,000	50,000
Panel Size ( diagonal )	21.5-inch Widescreen TFT color LCD	
Native resolution	1920 x 1080	
Colors	16.7 M	
Viewing Angle ( L/R/U/D )	85/85/80/80	
Response Time ( ms )	5	
Dot pitch ( mm )	0.248	
Display Area ( mm )	476.64H x 268.11V	
Surface treatment	Haze 25%, Hard-coating	
Surface hardness	3H	
Backlight Type	LED	

Video	
VGA	Analog 0.7Vp-p
DVI	DVI-D single link
Option	
HDMI	HDMI 1.4 / HDCP 1.4
Display port	DP 1.0 / HDCP 1.3
Composite ( BNC )	NTSC & PAL

Audio Option	
Input	
Connector	3.5mm stereo jack
Impedance / Power level	30kΩ / 750mV
Output	
Connector	3.5mm stereo jack
Resistance / Power level	30kΩ / 2.8V
Speaker:	
Dual Stereo	2W x 2

\*When the audio output is connected, speaker output is OFF

Power	Standard	Sunlight Readable
Input	Auto-sensing 100 to 240VAC, 50 / 60Hz	
Consumption:		
Screen ON	Max. 28W	Max. 32W
Power saving mode	Max. 2W	Max. 2W
Power button OFF	Max. 1W	Max. 1W

Compliance	
EMC	FCC & CE
Safety	CE / LVD & UKCA
Environment	RoHS3 & REACH / WEEE

## < 4.1 > Product Specifications

Environmental Conditions		
Operating	Temperature	0 to 55°C degree
	Humidity	10~90%, non-condensing
	Altitude	16,000 ft
Storage / Non-operating	Temperature	-20 to 60°C degree
	Humidity	5~90%, non-condensing
	Altitude	40,000 ft
	Shock	10G acceleration ( 11ms duration )
	Vibration	10~300Hz 0.5G RMS random vibration

Physical Specification	AP-F21 / HAP-F21	NAP-F21 / HNAP-F21	DP-F21 / HDP-F21	OP-F21 / HOP-F21	
Product ( W x D x H )	mm		577.8 x 59.1 x 369.3	546.8 x 56.4 x 338.3	574.8 x 52.6 x 366.3
	inch		22.7 x 2.3 x 14.5	21.5 x 2.2 x 13.3	22.6 x 2.1 x 14.4
Packing ( W x D x H )	mm		659 x 117 x 640	659 x 117 x 640	659 x 117 x 640
	inch		25.9 x 4.6 x 25.2	25.9 x 4.6 x 25.2	25.9 x 4.6 x 25.2
Net Weight	9 kg / 19.8 lb	9 kg / 19.8 lb	7.9 kg / 17.4 lb	6.7 kg / 14.7 lb	
Gross Weight	12.7 kg / 27.9 lb	12.7 kg / 27.9 lb	11.6 kg / 25.5 lb	10.4 kg / 22.9 lb	
Chassis color	Dark				
Chassis materials	Aluminum				

\* All dimensions stated are subject to change if options are selected / integrated to base model part codes

Applicable Format				
DVI-D / VGA Input	PC Signal	1920 x 1080 x 60Hz		
		1360 x 768 x 60Hz		
		1280 x 1024 x 60 / 75Hz		
		1280 x 960 x 60Hz		
		1280 x 768 x 60 / 75Hz		
		1152 x 864 x 75Hz		
		1024 x 768 x 60 / 70 / 75Hz		
		848 x 480 x 60Hz		
		800 x 600 x 60 / 72 / 75Hz		
		720 x 400 x 70Hz		
		640 x 480 x 60 / 72 / 75Hz		
		640 x 400 x 70Hz		
		640 x 350 x 70Hz		
	Audio Signal	2ch Linear PCM		
HDMI Input	PC Signal	Same as VGA		
		HDMI 1.4	1920 x 1080 x 50 / 60Hz ( 1080p )	
			1920 x 1080 x 25 / 30Hz ( 1080i )	
			1280 x 720 x 50 / 60Hz ( 720p )	
	720 x 480 x 50 / 60Hz ( 576p / 480p )			
	Audio Signal	2ch Linear PCM		
Display port Input	PC Signal	1920 x 1080 x 60Hz		
		1600 x 1200 x 60Hz		
		1360 x 768 x 60Hz		
		1280 x 768 x 60 / 75Hz		
		1280 x 768 x 60Hz		
		1024 x 768 x 60 / 70 / 75Hz		
		800 x 600 x 60 / 72 / 75Hz		
		720 x 400 x 70Hz		
		640 x 480 x 60 / 72 / 75Hz		
			Audio Signal	2ch Linear PCM

## < 4.2 > On-screen Display Operation ( OSD )

- Power light
- Green = On
- Orange = Power saving

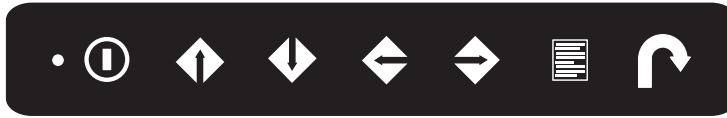

Membrane Switch	Function
	Power on / off LCD
	Display the OSD menu
	Scrolls through menu options and adjusts the displayed control (To auto adjustment by pressing the button  for 5 seconds)
	Exit the OSD screen Toggle analog, digital & video connection (DVI-D and video options only)

### ① Picture

Brightness : Adjust the screen brightness

Contrast : Adjust the difference between the image background ( black level ) and the foreground ( white level )

Black level : Adjust background black level of the screen

Eco : Screen in power saving mode

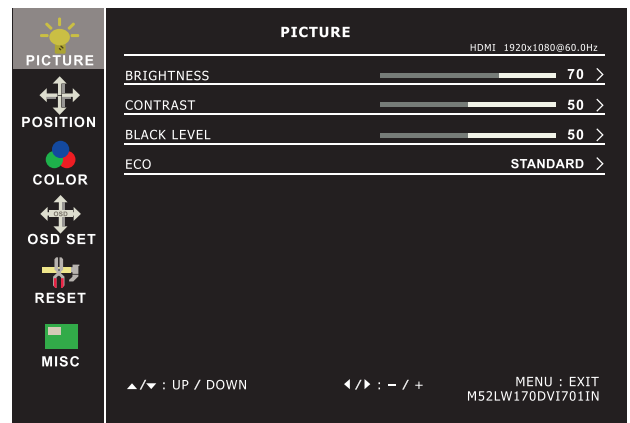

### ② Position

H-Position : To adjust the horizontal position of the video

V-Position : To adjust the vertical position of the video

Clock : To auto adjust H. Size of the screen

Phase : To fine tune the screen.

Picture size : FULL SCREEN / 4:3 / 5:4 / 16:10

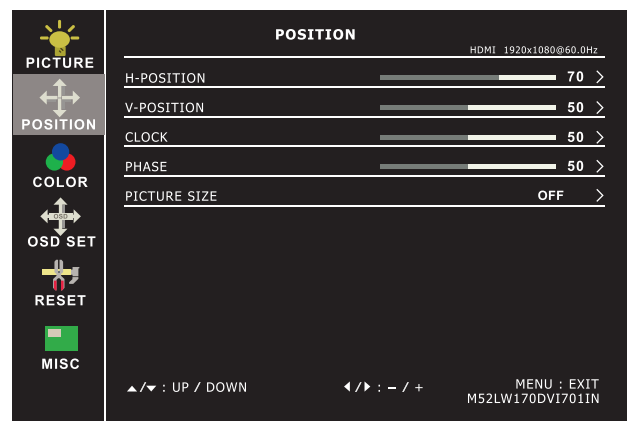

## 21.5" FHD LCD Display

### ③ Color

- Color temperature: User / Warm / Cool / 5400k mode and Red / Green / Blue color balance
- Sharpness : Adjust the image from weak to sharp
- Hue : Adjust the screen hue value
- Saturation : Adjust the saturation of the image color
- Dynamic luminous control : Control the dynamic brightness

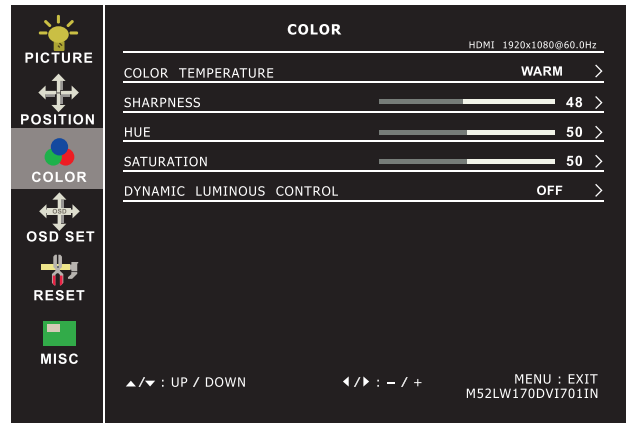

### ④ OSD Set

- Language : Select the language in which the OSD menu is displayed - English
- OSD H-Position : Align the screen image left or right
- OSD V-Position : Align the screen image up or down
- OSD time out : Adjust the screen timeout
- OSD transparency : Adjust the screen transparency
- OSD rotation : Rotate the screen - 90° / 180° / 270°

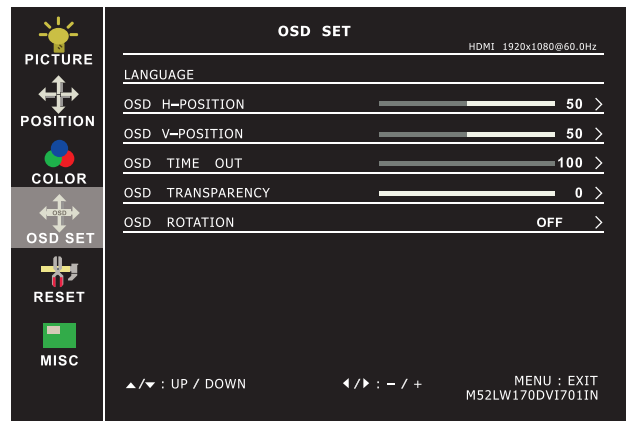

### ⑤ Reset

- Reset : Return the adjustment back to factory setting

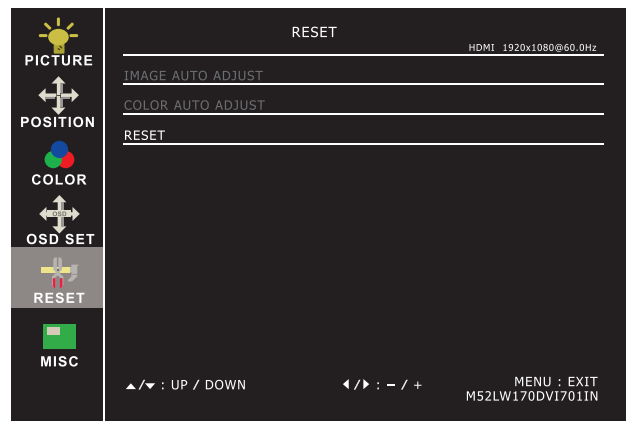

### ⑥ MISC

- Signal source : Select the signal source - DP / HDMI1 / HDMI2
- Mute : Turn off the surrounding sound
- Audio in : Auto / Line in / DP
- Volume : Adjust the volume of sound
- Sleep mode : Set the off time - 10 min / 20 min / 30 min / 50 min / 60 min / 120 min / 240 min

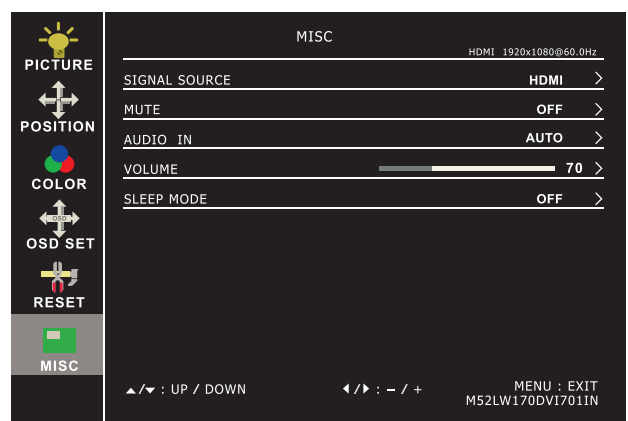

< Part 5 > Options  
 < 5.1 > Option Table

Options	AP / NAP	HAP / H NAP	DP	HDP	OP	HOP
SDI ***	✓	✓	✓	✓	✓	✓
S-Video * + Composite ( BNC )	✓	✓	✓	✓	✓	✓
Audio	✓	✓	✓	✓	✓	✓
Touchscreen	✓	✓	✓	✓	✓	✓
MCS multi-display control	✓	✓	✓	✓	✓	✓
DC Power	✓	✓	✓	✓	✓	✓
MIL-type / lockable connector	✓	✓	✓	✓	✓	✓
Quad display	✓	✓	✓	✓	✓	✓
Auto / switch dimming		✓		✓		✓



**\*\*\* About SDI**

The AD board comes standard with HDMI, VGA, S-Video, BNC, audio inputs and RC-2 remote controller.

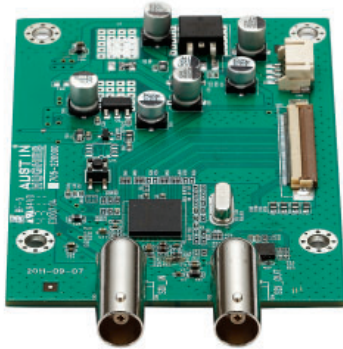

Austin Hughes' SDI input is an ideal solution for the broadcast-grade video and high resolution CCTV market.

Designed for use with UltraView displays, a SDI input module can support up to 1080p @60Hz resolution without using additional space or power and it comes standard with a 2-year warranty.

**SDI**

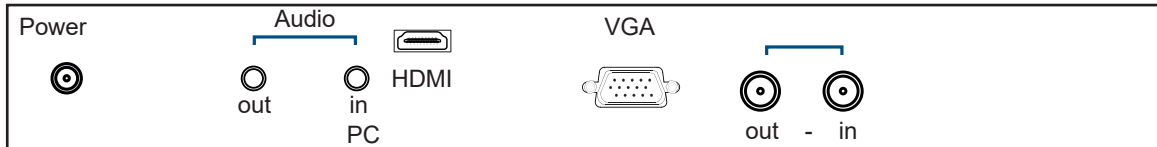

\*\*\* For **SDI** option, the AD board comes standard with HDMI, VGA, S-Video, BNC, audio inputs and RC-2 remote controller ( please refer to P.20 )

<b>INPUT</b>	3G-SDI IN	BNC x 1 / 0.8Vp-p ( 75 ohm )
	3G-SDI OUT	BNC x 1 / Active through, equalized & relocked

<b>Standard Compliance</b>	Video	SMPTE 425M / 274M / 296M / 125M ITU-R BT.656
	Audio	SMPTE 299M / 272M-C

<b>Compatible Video Format</b>	3G-SDI	1080p	@60 / 50Hz, 4:2:2
		1080p	@30 / 25 / 24Hz, 4:4:4
		1080i	@60 / 50Hz, 4:4:4
		720p	@60 / 50Hz, 4:4:4
	HD-SDI	1080p	@30 / 25 / 24Hz, 4:2:2
		1080i	@60 / 50Hz, 4:2:2
		720p	@60 / 50Hz, 4:2:2
SD-SDI	480i	@60Hz, 4:2:2	
ITU-R BT.656	576i	@50Hz, 4:2:2	

<b>Compatible Audio Format</b>	3G-SDI	48kHz, 16 / 20 / 24 bit, 2 CH, Synchronized Video
	HD-SDI	48kHz, 16 / 20 / 24 bit, 2 CH, Synchronized Video
	SD-SDI	48kHz, 16 / 20 / 24 bit, 2 CH, Synchronized / Asynchronous Video

<b>Max. Transmission Distance 75 ohm coaxial cable</b>	3G-SDI	150m at 2.97Gb/s
	HD-SDI	250m at 1.485Gb/s
	SD-SDI	480m at 270Mb/s

## < 5.3 > Options : MCS

### MCS ( Multi-display Control )

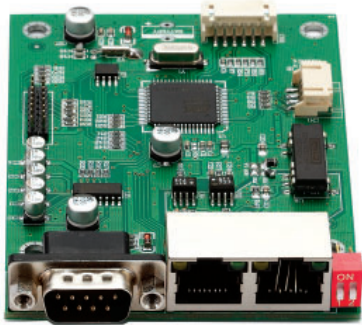

More control is always good. Especially when it is necessary and easy. Austin Hughes provides MCS solution to control the **OSD** of various UltraView LCD display up to 64 units.

The RS-232C is used for the communication between the PC and the first display via a 15 feet serial cable while the CAN bus is used for the various LCD displays cascade together via CAT 5/6 cable, and daisy chain up to 1,000 meters.

Designed for use with UltraView LCD displays, Austin Hughes provides a MCS input module without using additional space or power and it comes standard with a 2-year warranty.

### MCS

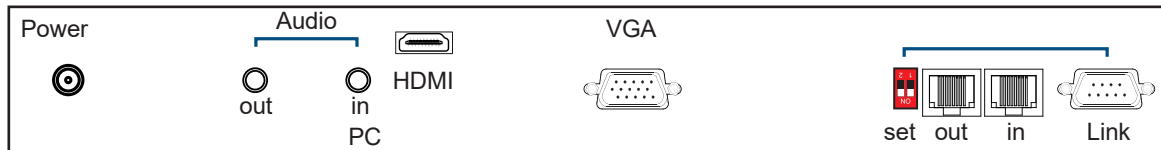

\*\*\* Please download the protocol of MCS control at :  
<http://www.austin-hughes.com/support/usermanual/ultraview/UM-UV-MCS.pdf>

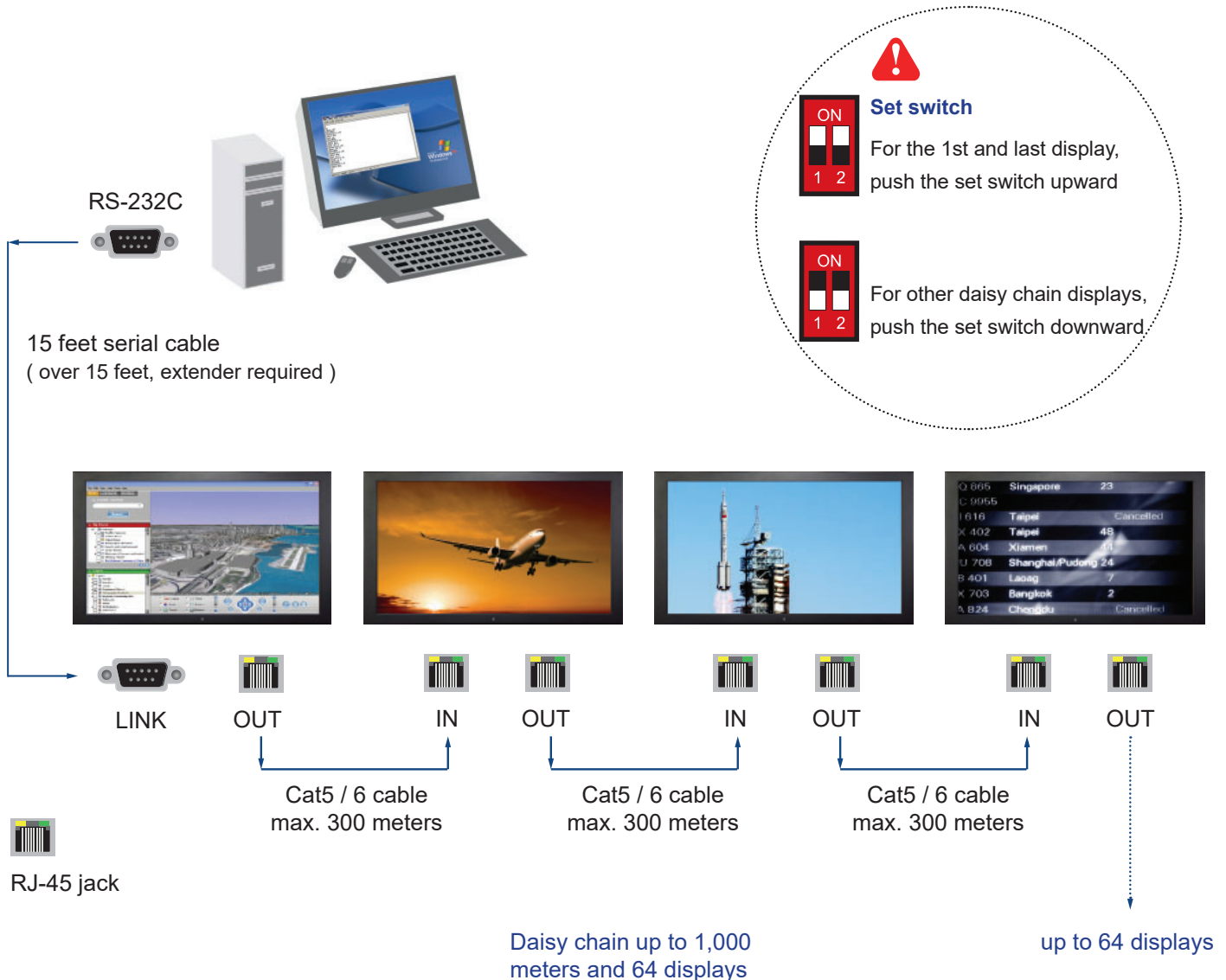



## < 5.4 > Upgrade Options :

21.5" FHD LCD Display

- **HDMI** ( HDMI 1.4, CEA-861-E )
- **Display Port** ( DP 1.0, HDCP 1.3 )
- **Audio** ( Built-in Dual Stereo Speakers, 2W x 2 )  
( 3.5mm audio jacks for audio in & out )

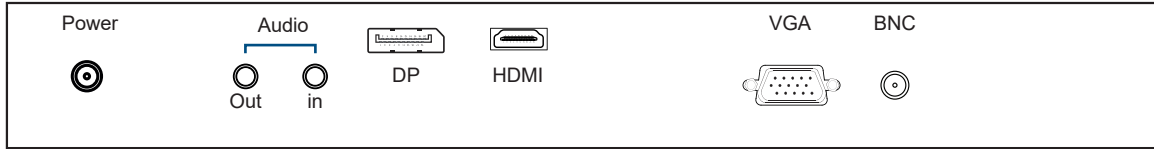

\*\*\*

Upgrade option comes with RC-2 remote controller x 2 ( please refer to P.21 )

# How to Use RC-2 Remote Controller

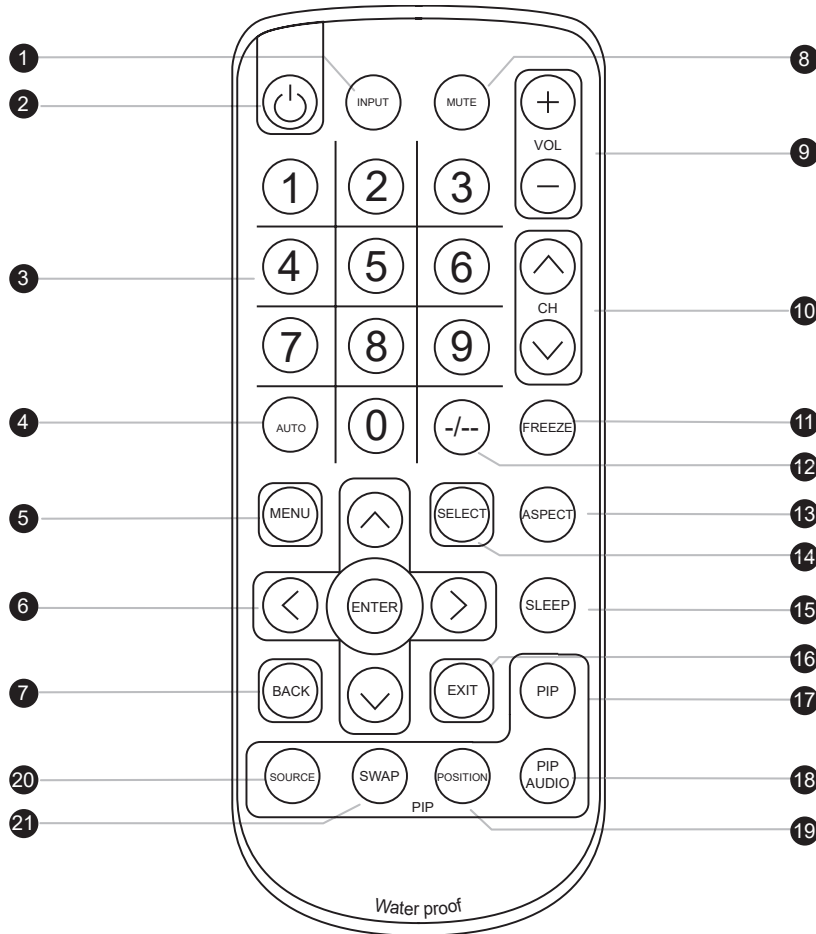

①	<b>INPUT</b>	Select the source
②	⏻	Switches on or off the TV
③	0 - 9	Only use in TV mode. Select channels. For channel numbers 10 and above, enter the second digit within two seconds.
④	<b>AUTO</b>	Auto adjust
⑤	<b>MENU</b>	Display the menu on the screen or go to the previous menu
⑥	▲ / ▼ / ◀ / ▶ / ENTER	Go to the upper menu or select the previous value / Go to the next menu or select the next value / Decrease the setting value / Increase the setting value or enter to the select item setting Enter to the select item settings or excude the setting
⑦	<b>BACK</b>	Back to previous value
⑧	<b>MUTE</b>	Turn on or off the speaker
⑨	<b>Vol + / -</b>	Increase or decrease the speaker volume
⑩	<b>CH + / -</b>	For TV model only, increase or decrease the channel number
⑪	<b>FREEZE</b>	Reserve for OEM model
⑫	- / --	For setting input single or double digits
⑬	<b>ASPECT</b>	Adjust the screen size
⑭	<b>SELECT</b>	To select the existing item
⑮	<b>SLEEP</b>	Select the sleeping time
⑯	<b>EXIT</b>	Exit the menu or cancel
<b>PIP functions</b>		
⑰	<b>PIP</b>	Picture in picture
⑱	<b>PIP AUDIO</b>	To set the audio of in PIP mode
⑲	<b>POSITION</b>	To set the screen position in PIP mode
⑳	<b>SOURCE</b>	PIP Source
㉑	<b>SWAP</b>	Swap screen in PIP mode



**F21" USB Touchscreen Specification**

Model	TPC-10 Multi-touch	TRB e-Resistive	TCB e-Capacitive
Technology	Projected Capacitive	5-Wire Resistive	Capacitive
Touch Point	10	Single	Single
Input Type	Finger or Capacitive Stylus	Finger or Stylus	Finger
Resolution	2048 x 2048	2048 x 2048	2048 x 2048
Touch Point Accuracy	± 25 mm offset	-	-
Response Speed	Max. 20 ms	15 ms	20 ms
Activation Force	≤ 10 g	≤ 50 g	≤ 50 g
Surface Hardness	7H	3H	9H
Light Transmission	≥ 88%	80% ± 3%	92% ± 2%
Haze	≤ 2%	8% ± 3%	7%
Durability	> 100 million touches	10 million touches	300 million touches
Top Layer	1.8 mm Tempered Glass	ITO Film	Glass
Bottom Layer	Film	ITO Glass	
Thickness	2.2 mm	3.2 ± 0.2 mm	2.8 mm ± 10%
Connector	USB Type A	USB Type A	USB Type A
Compatibility	Windows 7	Windows 7 / XP / Vista, Linux	

- Dimension will be changed if touchscreen required
- USB touchscreen package includes 1 x 6ft USB cable, quick reference guideline and CD disc
- For detailed information, please refer to the attached CD disc
- As the touchscreen unit is not made of toughened glass, please handle it carefully

**USB Touchscreen**

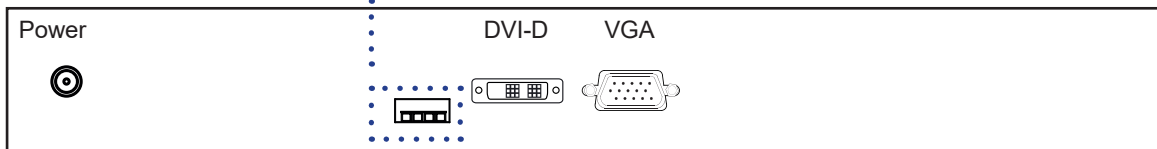

## < 5.5 > Options : Touchscreen & driver



### TPC-10 Driver



Connect the USB cable from the USB port on the LCD to a computer. The touch screen supports easy Plug-and-Play operations. There is no need to install additional drivers on the computer.

### TRB / TCB Driver

**Please follow the below steps to setup the touch screen:-**

**Step 1.** Run the bundled CD disc or download the driver from the link below :

<http://www.austin-hughes.com/resources/driver/ultraview>

**Step 2.** Double click the Setup.exe

**Step 3.** Follow the installation instruction to finish the setup

**Step 4.** After installation, run the TouchKit program & the “4 point calibration”



Please do the initial calibration after the first setup

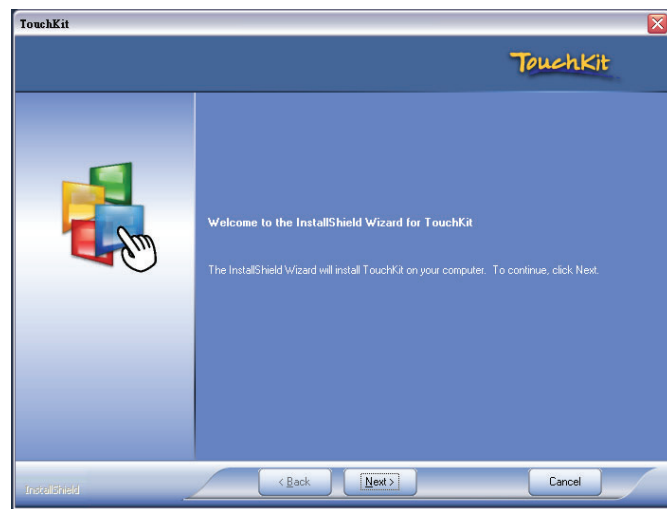

< 5.6 > Options : DC Power

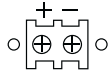

21.5" FHD LCD Display

Model	12V	24V	48V	125V
<b>Input rating</b>				
Input voltage:	12-Volt	24-Volt	48-Volt	110-Volt
Input range:	9 ~ 18V	18 ~ 36V	36 ~ 75V	66 ~ 160V
Input current				
- No load	50 mA	50 mA	50 mA	35 mA
- Full load	4950 mA	2450 mA	1220 mA	749 mA
<b>Output rating</b>				
Output voltage:	12-Volt	12-Volt	12-Volt	12-Volt
Output current:	4.16A	4.16A	4.16A	6.25A
<b>Efficiency</b>	84%	85%	85%	91%



\*\*\* For DC power option :

( 1 ) If the unit with LCD, earthing may be required 

## < 5.7 > Options : MIL-type or Lockable Connector

	Input	Part no.	MIL Standard
<b>MIL - type Connector</b>	DC Power *** ( Male )	MS3470W8-33P 	MIL - DTL - 26482
	VGA *** ( Male )	MS3470W14-15P 	MIL - DTL - 26482

\*\*\* There are several additional MIL DC and VGA connector types with varying design characteristics to meet cost considerations and to provide users with the most design flexibility possible. For more information, please contact us.

	Input	Part no.	Standard
<b>Lockable Connector</b>	DC Power ( Male )	YM-Ext-461CP001 	D-type 3W3
	USB	LUSB - A111 - 00 	-

\*\*\* MIL - type or Lockable connectors above can be integrated with our LCD displays. Sale service just for connectors not provided.

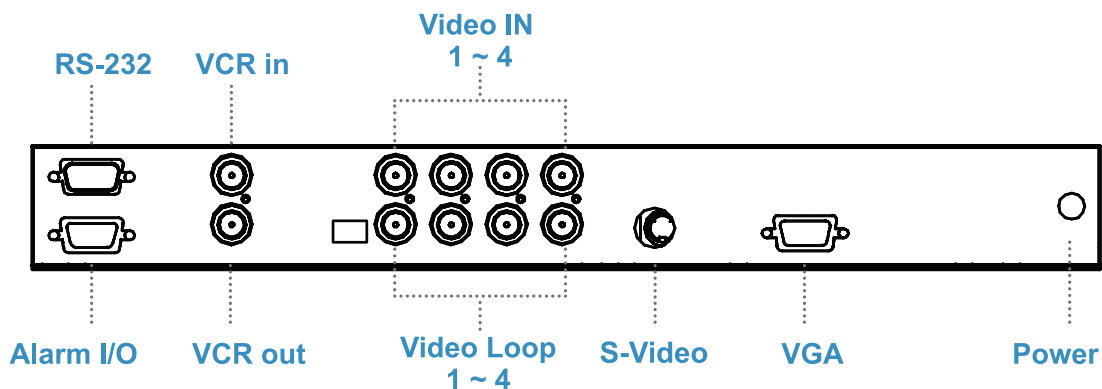

### QD Specification

Item		Description	
Model Number		QD (NTSC)	QD (PAL)
Number of Color		16.7 M	16.7 M
Imaging System		NTSC	PAL
Resolution		1024 x 525	1024 x 625
Refresh Rate		60	50
Video Input	Camera Input	1.0 Vpp, 75 Ohm x 4	
	VCR Input	1.0 Vpp, 75 Ohm x 1	
Video Output	Live Monitor	1.0 Vpp, 75 Ohm x 1	
	Loop Through Out	1.0 Vpp, 75 Ohm x 4	
	VCR Output	1.0 Vpp, 75 Ohm x 1	
Auto Gain Control		Yes	
Time / Date		Yes	
On Screen Display		Yes	
Camera Title		8 Character Title	
Display Format	2 x Zoom On Playback	Yes	
	QUAD	Yes	
	FULL	Yes	
	SEQUENCY	Yes	
Dwell Time		0 to 99 Sec Adjustable	
Alarm Inputs		Selectable NO/NC Contacts x 4	
Relay Outputs		NO/NC contacts x 1: 1A @DC24V Max.	
Alarm Hold Time		1 Sec to Non-stop	
Built-in Buzzer		Yes	
Key Lock		Yes	

\*\*\* For QD option, casing dimensions will be changed.

## < 5.9 > Options for Sunlight Readable : Auto Dimming

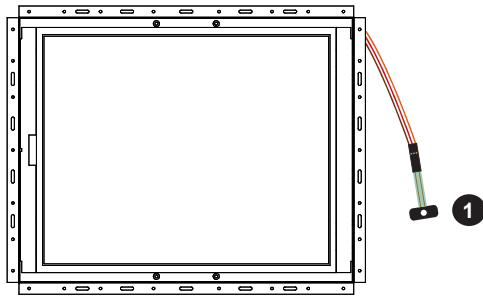

① DA-01 Light sensor on **OP** model  
( 66cm from AD board to sensor end )

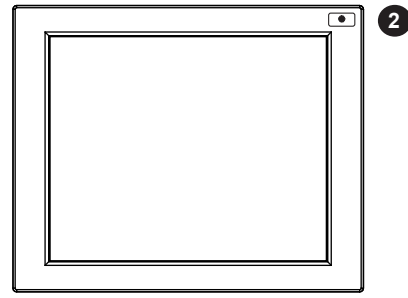

② DA-01 Light sensor on **AP** model

**DA-01** light sensor installed on the display front panel. Users can set auto dimming ON or OFF from OSD menu. Then display brightness changes according to its ambient brightness. Each change causes 10% increase or decrease on display brightness.

Once the auto dimming is ON, users cannot adjust brightness from OSD menu.

Steps : OSD Menu > Picture > Auto Dimming > ON

### Light Sensor Operation Range

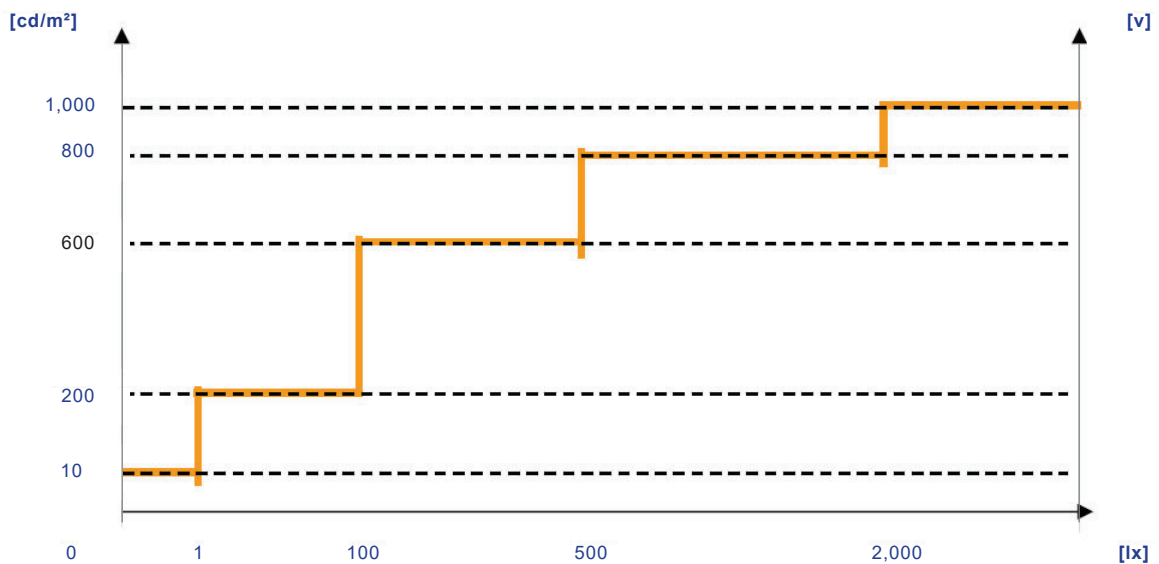

## Options : Switch Dimming

**DS-01** is a IP54 dimming knob installed on the bottom right side of the front panel. The display can support hyper dimming function to adjust brightness from nearly 0% to 100% via the easy-to-use knob. One click on dimming knob causes 2% increase or decrease on display brightness.

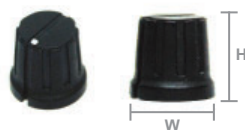
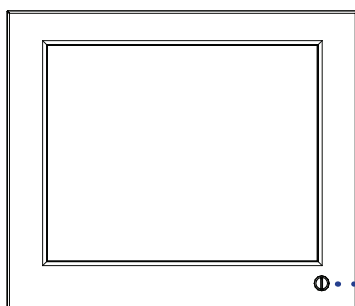

**DS-01 dimming knob**  
Dimensions ( W x H ) : 15.5 x 14.2 mm

\*\*\*

- For this option, front panel and casing dimensions may be changed.
- For HAP series, if DS-01 dimming knob applied, IP protection will be downgraded from IP65 to IP54.



# < 6 > Ultraview F21 Family

21.5" FHD LCD Display

250 cd/m<sup>2</sup> Brightness

1000 cd/m<sup>2</sup> Sunlight Readable Brightness

6mm aluminum front bezel

6mm aluminum front bezel



AP-F21



HAP-F21

6mm aluminum front bezel  
NEMA 4 / IP65 front protection

6mm aluminum front bezel  
NEMA 4 / IP65 front protection

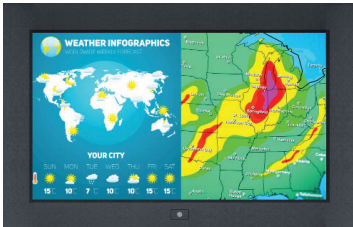

NAP-F21



HNAP-F21

Aluminum front cover

Aluminum front cover

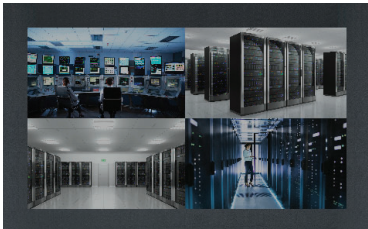

DP-F21

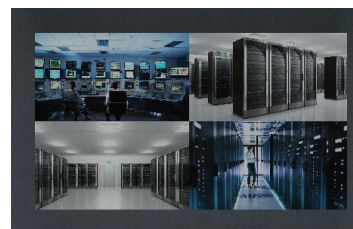

HDP-F21

Universal open frame

Universal open frame



OP-F21



HOP-F21

## MP-F21

Industrial Display Kit

- FHD 21" LED
- LCD controller
- AC power

Intentionally  
Left  
Blank

# Intentionally Left Blank

The company reserves the right to modify product specifications without prior notice and assumes no responsibility for any error which may appear in this publication.

All brand names, logo and registered trademarks are properties of their respective owners.

Copyright 2022 Austin Hughes Electronics Ltd. All rights reserved.