

# MODEL 9110

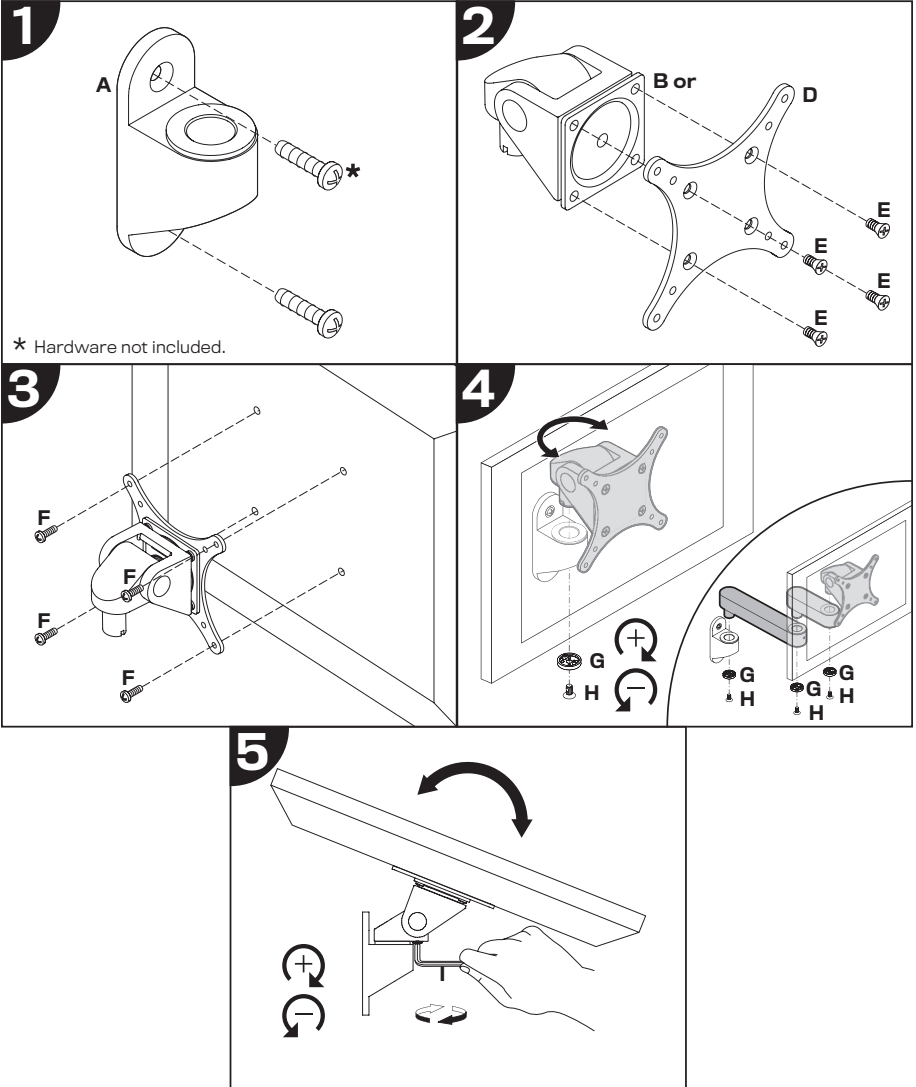









\* Hardware not included.

# MODEL 9110

**NOTE:** THERE MAY BE ADDITIONAL PARTS UNDER TRAY.

PLEASE REVIEW ENTIRE PACKAGE PRIOR TO DISCARDING.

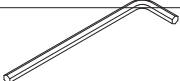
ITEM	DESCRIPTION / PART NO.	QUANTITY		
		9110	9110-4 & 9110-8.5	9110-8.5-4
A 	<b>Wall Mount</b> RP406795	1	1	1
B 	<b>Monitor Tilter</b> 405397	1	1	1
C  1	<b>Spring-Assisted Monitor Tilter</b> (9110-HD only) 407747		1	1
D 	<b>75mm/100mm VESA® Adapter Plate</b> 105587	1	1	1
E 	<b>10-32 x 3/8" Phillips Flat Head Screw</b> 702281	1 (4-pack)	1 (4-pack)	1 (4-pack)
F 	<b>M4-12 Phillips Pan Head Screw</b> 702096	1 (4-pack)	1 (4-pack)	1 (4-pack)
G 	<b>Dog Washer</b> 105189	1	2	3
H 	<b>10-32 x 3/8" FPHMS w/Lock Patch</b> 705198	1	2	3
I 	<b>7/32" Allen Wrench</b> 701127	1	1	1